

PRINTRONIX®

IGP® / PGL® Emulation
Printronix Graphics Language
Programmer's Reference Manual

Line Matrix Series Printers

Trademark Acknowledgements

IBM and IBM PC are registered trademarks of International Business Machines Corp.

IGP, LinePrinter Plus, PGL, and Printronix are registered trademarks of Printronix, LLC.

This product uses Intellifont Scalable typefaces and Intellifont technology. Intellifont is a registered trademark of Agfa Division, Miles Incorporated (Agfa).

CG Triumvirate are trademarks of Agfa Division. CG Times, based on Times New Roman under license from The Monotype Corporation Plc is a product of Agfa.

Printronix, LLC. makes no representations or warranties of any kind regarding this material, including, but not limited to, implied warranties of merchantability and fitness for a particular purpose. Printronix, LLC. shall not be held responsible for errors contained herein or any omissions from this material or for any damages, whether direct, indirect, incidental or consequential, in connection with the furnishing, distribution, performance or use of this material. The information in this manual is subject to change without notice.

This document contains proprietary information protected by copyright. No part of this document may be reproduced, copied, translated or incorporated in any other material in any form or by any means, whether manual, graphic, electronic, mechanical or otherwise, without the prior written consent of Printronix, LLC.

COPYRIGHT 2009, 2013, 2016 PRINTRONIX, LLC.

All rights reserved.

Table of Contents

1	Introduction	9
	About this Manual.....	9
	Warnings and Special Information	9
	The IGP/PGL Emulation.....	9
	Features	9
	How the IGP/PGL Operates.....	10
	Modes of Operation	11
	Alphanumeric Data	17
	Incremental Data.....	17
	Configuring The IGP/PGL With The Control Panel	17
	Flash Memory Storage	18
	Flash Memory Utilization.....	18
	Printers with SD Capability	18
2	Commands	21
	IGP/PGL Command Standards	21
	Special Function Control Code (SFCC).....	21
	Semicolon (;).....	21
	Uppercase.....	21
	Inline Commands	21
	Line Terminator	22
	Printable Character	22
	Spaces	22
	Command Parameters.....	22
	Form Name	22
	Prompt.....	23
	Numeric Values.....	23
	Comments in Command Lines	23
	Storing Data	23
	Uncompressed and Packed Bits Compression	23
	Character Position.Dot Position (CP.DP) Format	24
	Command Codes.....	25
	Data Fields for Alphanumeric and Incremental Data	25
	Alphanumerics	26
	Alphanumerics, Incremental Fields.....	30
	Alphanumerics, Incremental: Fixed Data Fields	34
	Alphanumerics, Incremental: Dynamic Data Fields	36
	Boxes	39
	Cancel	41

Circle	42
Compressed Print (Density)	43
Clock Element Format	43
Configuration	45
Corners	49
CREATE	51
Dark Printing	52
Define Month Names	52
Delete Font	52
Delete Form	53
Delete Logo	53
Directory	54
Duplication, Horizontal	54
Duplication, Vertical	55
Emulation Switching	57
End	57
Enquiry	57
Execute Form Mode	57
Execute Form: General Format	58
Execute Form: Electronic Vertical Format Unit	61
Execute Form: Dynamic Alphanumeric Data	61
Execute Form: Dynamic Bar Code Data	62
Execute Form: Dynamic Logo	63
Execute Form: Incremental Dynamic Data	63
Execute Form: Overlay Data	65
Expanded Print	65
Font	66
Font Load	68
Form Length	69
Hex Character Encoding	70
Ignore Sequence	70
Line Spacing	71
Lines, Diagonal	71
Lines, Horizontal	72
Lines, Vertical	73
Link	74
Listen	76
Logo Call	76
Logo Mode, Create	78
Normal Mode	80
Optimize	80
Page Number	81
Paper	81

Paper Instruction - Data Bit 8.....	82
Paper Instruction (PI) Enable/Disable.....	83
PCX Logo.....	83
PNG Logo.....	84
Print File.....	86
Printer Alert.....	86
Printer Identification.....	89
Printer Mode.....	89
Printer Status.....	92
Quiet.....	93
Recall.....	93
Repeat.....	93
Reset.....	94
Reverse Print.....	94
Scale.....	95
Scaling.....	96
Select Format.....	98
Set The Time or Date.....	98
Setup.....	99
Special Function Control Code Change.....	101
TIFF Logo.....	101
3 Bar Codes.....	103
Overview.....	103
User-Defined Variable Bar Code Ratios.....	104
User-Defined Variable Ratios for Postal Barcodes.....	105
PDF Character Sizes [PDF [;LOC] [;FONT]].....	106
Bar Code Specifications.....	106
Bar Codes.....	108
Australian 4-State.....	108
Codabar.....	113
Code 35.....	118
Code 39.....	120
Code 93.....	126
Code 128A, 128B and 128C.....	131
EAN 8.....	141
EAN 13.....	146
FIM.....	152
GS1-128.....	158
GS1 Datamatrix.....	170
Data Matrix Example.....	178
HIBC Barcode.....	179
Intelligent Mail 4-State Barcode.....	181

Interleaved 2/5 (I-2/5), German I-2/5, and ITF-14	184
Matrix	189
MSI.....	193
PDF417	198
Planet.....	206
Plessey.....	211
POSTNET	216
PostBar and Royal Mail (KIX)	221
QR Barcode	224
Telepen	228
UPC-A	233
UPC-E and UPC-E0.....	238
UPCSHIP	245
UPS 11.....	249
Incremental Bar Code Fields.....	253
Incrementing Bar Code Data	253
Incremental Bar Code Fixed Data Fields.....	255
Incremental Bar Code Dynamic Data Fields.....	256
Duplicating Incremental Bar Code Fields	258
4 Form Examples And Exercises	259
Form Examples	259
CREATE Mode (Allowed – no SFCC required)	259
NORMAL Mode (Not Allowed – SFCC required).....	259
EXECUTE Mode (Not Allowed – SFCC required)	259
Example: Create Commands.....	260
Example: Using The Setup Command	261
Example: Dynamic Data	262
Example: Auto Increment Fields.....	267
Form Exercise	270
Creating A Box And Corners.....	270
Adding Horizontal And Vertical Lines	272
Adding Fixed Alphanumeric Text.....	273
Adding A Bar Code	275
Logo Exercise.....	277
Creating A Logo	279
Form Design	281
Page Layout Considerations.....	281
Planning The Form Layout.....	281
Creating A Form And Adding Form Components.....	285
Directory Command.....	288
Example	288
Delete Command.....	289

Example	289
Solving Program Errors	289
Example	290
5 Multinational And International Character Sets	291
Multinational Character Sets	291
Supported Character Sets	291
Character Addresses	292
Making Character Substitutions	292
Double Byte Character Set.....	294
Accessing Characters and Character Sets	295
OCR Character Sets	295
Extended Character Sets.....	295
Data Bit 8	295
Power-Up Character Set Selection.....	295
User-Defined Set Command (USET).....	296
Character Set Selection Command (ISET).....	297
Downloading A Block Character	299
Downloading A User-Defined Overlay Set.....	300
Activating A User-Defined Overlay Set.....	300
Disabling An Overlay Set	301
Examples for Downloaded Block Characters & Overlays.....	301
Setting The Expanded Font Menu Option	302
Downloaded Font Menus	302
Multinational Character Set Charts.....	303
International Character Sets	307
6 Error Codes	309
IGP/PGL Emulation Error Codes.....	309
Horizontal Line Errors	310
Vertical Line Errors	311
Box Errors	312
Corner Errors	313
Alpha Errors	314
Logo Errors	315
Create Errors	316
Execute Errors	317
Miscellaneous Errors	318
Bar Code Errors.....	319
Reverse Print Errors	320
Miscellaneous Errors	321
Incremental Fields Errors.....	322
Miscellaneous Errors	322
Multinational Character Set Errors.....	323

Font Errors	324
Bar Code Errors	325
Miscellaneous Errors	325
A Compatibility Across Models	327
Overview.....	327
Normal Mode Commands	327
Create Mode Commands	329
Execute Mode Commands	330
B Standard ASCII Character Set	331
C Grid Programs And Samples	333
D Page Boundaries	337
Paper Selection and Maximum Values	337
Create Form Mode	337
Execute Form Mode.....	337
Setting Top/Bottom Margins	338
Setting Left Margins	339
E Vertical Paper Motion	343
Introduction.....	343
Paper Motion Using Line Feeds and Form Feeds	343
Paper Motion using the PI Line (Relative Line Slewing)	343
Paper Motion using the EVFU	344
General EVFU Programming.....	344
EVFU Programming Sequence	345
Using the EVFU	346
Clearing the EVFU Memory.....	347
EVFU Example	347
F Typefaces	351
Standard Typefaces	351
Line Matrix.....	351
G PGL-DBCS	353
TWOBYTE Command Syntax.....	353
EXECUTE Mode Command Syntax (Common)	355
H Contact Information	357
Printronix Customer Support Center	357
Printronix Supplies Department	357
Corporate Offices.....	358

1 *Introduction*

About this Manual

This manual explains how to use the IGP®/PGL® (Intelligent Graphics Printing/Printronix Graphics Language). Use this manual in conjunction with your printer's *Administrator's Manual* for complete printer-IGP/PGL compatibility.

Warnings and Special Information

Information requiring special attention is highlighted under special headings. Always read and comply with this information. The heading reveals the nature of the information:

WARNING **WARNING** tells you of conditions that could cause you physical harm.

CAUTION **CAUTION** tells you of conditions that could damage the printer or related equipment.

IMPORTANT **IMPORTANT** give you information vital to proper IGP/PGL operation.

NOTE: Provides information affecting IGP/PGL operation considered important enough to emphasize.

The IGP/PGL Emulation

IGP/PGL is the Intelligent Graphics Printing software for the Printronix Graphics Language, which is designed for Printronix printers. The IGP/PGL provides on-line forms, bar codes, and many alphanumeric text-generation capabilities and is compatible with earlier versions of Printronix IGP protocol and programming. IGP/PGL graphics processing features are detailed below.

Features

On-Line Form and Label Generation makes it easy to create forms or labels with a "preprinted" look for each application. IGP/PGL programs control all graphic functions, dramatically reducing host computer programming and processing time.

Graphic capabilities include boxes, vertical and horizontal lines with user-selectable thickness, logos, and special alphanumeric print features. Forms and graphic designs can be duplicated horizontally and vertically.

Alphanumeric data can appear as prepositioned "fixed" information (entered when the form is created), can be overlaid onto the form (positioned in a specific location after the form is created), or may be dynamically merged with the form.

Selectable Bar Codes provide you with the appropriate bar code for your application using standard wide-to-narrow ratios. A wide selection of bar codes are available: Australian 4-State, Codabar, Code 39, Code 93, Code 128 Subset A, B and C, Data Matrix, EAN 8, EAN 13, FIM, Interleaved 2 of 5, German I-2/5, ITF 14, Matrix, Maxicode, MSI A through D, PDF-417, Planet, Plessey, POSTNET, USPS Intelligent Mail, PostBar, Royal Mail, UCC/EAN-128, UPC-A, UPC-E, UPCSHIP, and UPS 11. UPC and EAN bar codes can also specify add-on data. See Table 11 on page 103 for a complete list of bar codes.

Expanded and Compressed Character Print attract attention where needed. Alphanumeric height and width are controlled independently for a wide range of character sizes up to 139 times the standard character size (up to 13.9 inches wide and tall). Compressed print sizes of 10 to 30 characters per inch (cpi) are available.

Rotated Alphanumerics permit new concepts in form design. Normal, expanded, and compressed character strings can be rotated 90 degrees clockwise or counterclockwise, or they can be printed upside down.

Logos are easily created using alphanumeric commands and add a variety of print and shading features for a “customized” appearance to forms, reports, and labels. You can define the format of the logo using TIFF files and PCX raster data as well as the standard IGP/PGL dots. Logos can also be dynamically merged with the form.

Reversed Print permits highlighting and contrasting by printing white characters on a dark background.

Automatic Increment/Decrement Capability allows batch form processing. You can identify individual numeric and bar code data fields, which includes automatic increment or decrement functions.

How the IGP/PGL Operates

IGP/PGL is an emulation that allows you to print sophisticated graphics and bar codes.

The printer is always in a particular mode, which is transparent to the user. When the printer is receiving text or printing text, it is in Normal mode. Any time the printer is on and is not processing IGP/PGL commands, it is in Normal mode.

When a Create Form command is issued, the printer moves from the Normal mode to the Create Form mode. During this phase, the user sends text, images, and bar code data to the IGP/PGL. All of this data is stored in memory. An END statement terminates the IGP/PGL data string. The printer returns to Normal mode.

You can create as many forms as you wish and store them on your host. You can also save forms to the Onboard Flash Memory or SD card (if available).

All forms have filenames. You may want to print the form, label it, and store it for future reference. Or, you can devise another method for easy retrieval.

These forms can then be downloaded from your host to the printer.

When you Execute a form, you can print it as many times as you wish. This saves you time from downloading the form each time you want to print it.

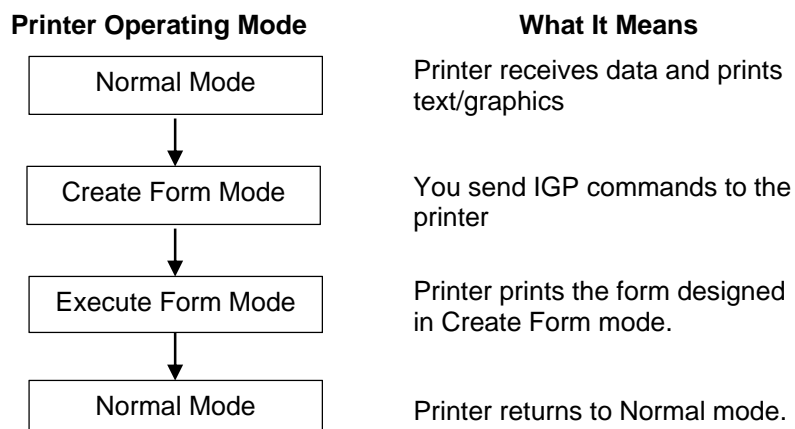

Figure 1 IGP/PGL Modes

Modes of Operation

The IGP/PGL has six modes of operation that use specific command sequences to control the IGP/PGL.

- In Quiet mode all IGP/PGL commands (except LISTEN) are ignored.
- In the Normal mode, the printer waits for an SFCC in order to perform IGP/PGL functions.
- In the Create Logo and Create Form modes, the printer produces graphics such as forms, logos, bar codes, and alphanumeric data.
- The Configuration mode allows you to select specific IGP/PGL operations for running IGP/PGL files on your printer.
- The Execute mode is the IGP/PGL printing mode, which controls when the actual printing of the bar codes and graphics occurs.

Quiet Mode

In this mode, the host passes all data to the LinePrinter+ emulation without any IGP/PGL interpretation. The IGP/PGL is disabled and all IGP/PGL commands are ignored. The IGP/PGL looks only for the LISTEN command.

Normal Mode

Normal mode commands print data in a line printer format until a Special Function Control Code (SFCC) is detected.

Commands accessible in the Normal mode are summarized in Table 1 on page 11 and fully described on the referenced pages. Some Normal mode commands can also be used in other modes: Compressed Print, Expand, Ignore, Select Format, and Vertical Line Spacing, which are Normal mode commands, can also be used in the Execute Form mode; the Multinational Character Set command can be used in the Normal or Create modes. Carriage Return, Form Feed, Line Feed, and Paper Slew commands also operate in the Normal mode.

NOTE: All IGP/PGL commands must be entered in UPPERCASE, and each command line must be followed immediately by a line feed (or carriage return with line feed terminator), a paper motion command, or an inline command.

Table 1 Normal Mode Commands

Command	Mnemonic	Description	Page #
Cancel	CANCEL	Cancels the print job immediately as soon as the command is sent to the printer during the print job.	41
Change SFCC	SFCC	Changes the Special Function Control Code character.	101
Compressed Print	DENSITY	Defines the horizontal print density in characters per inch (cpi).	43
Configuration	CONFIG	Reconfigures IGP/PGL parameters.	45
Create	CREATE	Places the IGP/PGL in the Create Form mode where all the Create Form mode commands are available to design form elements.	51

Table 1 Normal Mode Commands

Command	Mnemonic	Description	Page #
Create Logo	LOGO	Places the IGP/PGL in the Create Logo mode, where logos can be defined using the appropriate dot placements.	78
Delete Font	DELETE FONT	Deletes the font identified by the font name which resides in flash memory only.	52
Delete Form	DELETE FORM	Deletes a selected form name from the directory and IGP/PGL memory.	53
Delete Logo	DELETE LOGO	Deletes a selected logo name from the directory and IGP/PGL memory.	53
Directory	DIRECTORY	Provides a list of all defined forms and logos, logo assignments to forms, and memory usage and availability.	54
Emulation Switch	EMULATION	Switch emulation from IGP/PGL to IGP/VGL (if VGL is present).	57
Enquiry	ENQUIRY	Sends information about the printer state to the host through the serial port.	57
Execute	EXECUTE	Executes a previously created form.	57
Expanded Print	EXPAND	Expands fonts vertically and horizontally.	65
Font	FONT	Selects a specific typeface, bold, slant (italic) factor, and symbol set.	66
Font Load	FONTLOAD	Load binary TrueType Font or Intellifont into RAM or Flash memory.	68
Hex Sequence On/Off	HEXON HEXOFF	Enables the IGP to interpret all data as hex characters 0-9, A-F. Any data not sent as hex digits is ignored until the HEXOFF command is sent.	70
Ignore Sequence On/Off	IGON IGOFF	Enables the IGP/PGL to ignore all characters after the Ignore Sequence On command is sent until the Ignore Sequence Off command is sent. See Note on page 15.	70
Line Spacing, Vertical	LPI	Defines the lines per inch (lpi) printing format.	71
Link	LINK	Prints forms created in the CREATE mode, used exclusively for XML driven forms.	74
Listen	LISTEN	Removes IGP/PGL from the Quiet state and enables IGP/PGL operation.	76
Month Name	MONTH	Allows the creation of user-defined strings to be used as full and abbreviated month strings in the clock elements.	52
Multinational Character Set	USET ISET	Use a multinational character set or create a custom user- defined character set.	Chap. 5

Table 1 Normal Mode Commands

Command	Mnemonic	Description	Page #
Normal Mode	NORMAL	Places the IGP/PGL in the Normal mode, where it does not change the data stream but awaits the SFCC followed by an IGP/PGL command.	80
Optimize	OPTIMIZE	Optimizes the flash file in memory and then reboots.	80
Paper	PAPER	Controls printer paper options, such as page orientation, intensity and ribbon use.	81
Paper Instruction Enable/Disable	EN-PI DIS-PI	Enables or disables use of the PI line with a parallel interface.	83
Paper Instruction On/Off for Data Bit 8	PION PIOFF	Enables or disables Data Bit 8 as the paper instruction signal in a serial interface.	82
Print File	PRINT	Prints a file from the flash memory.	86
Printer Identification	IDENTITY	The printer identification command.	89
Printer Status	STATUS	Requests the printer status.	92
Quiet	QUIET	IGP/PGL operation is disabled until a Listen command is received. Any data sent to the LinePrinter Plus Emulation is unaffected by IGP/PGL commands.	93
Recall	RECALL	Recalls forms or logos from memory.	93
Reset	RESET	Deletes all forms and logos from the IGP/PGL memory or the printer flash memory.	94
Set Clock	SETCLOCK	Sets the internal printer-clock to the current time and date.	98
Select Format On/Off	SFON SFOFF	Ignores all host-generated paper movement commands. See Note on page 15.	98
Set Up	SETUP	Automatically executes and loads the IGP/PGL commands into the printer at power-up or after a RESET command is sent.	99

Create Form Mode

Create Form mode commands design forms, all form components, and bar codes. The forms are not printed in the Create Form mode; forms are printed in the Execute Form mode after all form design is completed. To begin form design, access the Create Form mode using the Create command. The Create command is always used to enter the Create Form mode to begin form design. Remember that the CREATE command must be entered in UPPERCASE.

Each element has its own specific set of commands and parameters that determine size, location, and content. Listed in alphabetical order, Create Form mode commands are summarized in Table 2 and fully described on the referenced pages.

The following commands are included for compatibility, and are not recommended for use: CUT, ENQUIRY, SMODE, and XON.

Print Boundaries

Print area boundaries exist for the paper size selected. All Create Form mode commands require you to identify the location for the components in your form. Boundary checking for form elements is performed only when the form length is specified. This ensures that forms can be created regardless of the type of paper you have loaded or margins you have set. The IGP/PGL checks the boundaries before the form is executed to assure that it fits on the loaded paper size. If the debug option is used in the create statement, the boundaries are checked against the current paper size. Refer to Appendix 0 for more information regarding page boundary guidelines.

Table 2 Create Form Mode Commands

Command	Mnemonic	Description	Page #
Alphanumerics	ALPHA	Defines size, location, and content of alphanumeric characters and dynamic alphanumeric data fields.	26
Alpha, Incremental	ALPHA	Defines starting data and increment amount for fixed auto-increment fields.	30
Bar Codes	BARCODE	Each bar code type has its own command to define size, location, orientation, and data as described in the Bar Codes chapter.	Chap. 3
Boxes	BOX	Defines size, location, and thickness of boxes.	39
Circle	CIRCLE	Produces a circle on the printed table.	42
Corners	CORNER	Defines vertical and horizontal length, location, and thickness of a set of four corners.	49
Duplication, Horizontal	HDUP	Defines the number of horizontal duplications of an element and the spacing between duplications.	54
Duplication, Vertical	VDUP	Defines the number of vertical duplications of an element and the spacing between duplications.	55
End	END	Terminates the Create Form mode.	57
Font	FONT	Selects a specific typeface, bold, slant (italic) factor, and symbol set.	66
Form Length	LFORM	Specifies form length by total number of lines at 6 or 8 lpi.	69
Ignore Sequence On/Off	IGON IGOFF	Enables the IGP/PGL to ignore all characters after the Ignore Sequence On command is sent until the Ignore Sequence Off command is sent. See Note on page 15.	70
Lines, Diagonal	DIAG	Defines the location, size, and thickness of diagonal lines.	71
Lines, Horizontal	HORZ	Defines the location, size, and thickness of horizontal lines.	72
Lines, Vertical	VERT	Defines the location, size, and thickness of vertical lines.	73
Logo Call	LOGO	Specifies the location of a previously defined logo.	76

Table 2 Create Form Mode Commands

Command	Mnemonic	Description	Page #
Logo Mode, Create	LOGODEF	Defines vertical and horizontal length and dot placement for logos.	78
Multinational Character Set	ISET	Use a multinational character set or create a custom user- defined character set.	Chap. 5
Page Number	PAGE	Defines the location for automatically incremented page numbers.	81
Printer Mode	PMODE	Selects the print mode of the printer for the next set of data and allows different print modes to be specified for use within the form.	89
Reset	RESET	Deletes all forms and logos from the IGP/PGL memory or the printer flash memory.	94
Reverse Print	REVERSE	Defines the location for white-on-black printing and selects the background shade.	94
Scale	SCALE	Defines the vertical spacing and horizontal pitch for data positioning in character or dot columns and rows.	95
Scaling	SMODE	Permits graphic elements (such as corners or boxes) to retain their physical shapes and sizes when printed in a horizontal and vertical density other than the base density of 60 x 72 dpi.	96
Select Format On/Off	SFON SFOFF	Ignores all host-generated paper movement commands. See Note on page 15.	98

Create Logo Mode

The Create Logo mode is used in the Create Form mode. The Create Logo mode creates a logo design; this predefined logo is then “called” into a form in the Create Form mode. (The logo must be defined before it is “called.”)

Execute Form Mode

The Execute Form mode prints forms created in the Create Form mode. Execute Form mode commands are summarized in Table 3 and fully described on the referenced pages. Carriage Return, Form Feed, and Line Feed commands also operate in the Execute Form mode. Remember that the EXECUTE Form command must be entered in UPPERCASE, and that a single line spacing (or a line containing overlay data) must separate an EXECUTE command from a NORMAL command.

NOTE: Some systems pad the data stream with characters and spaces. If the IGP/PGL file on your system contains padded characters or spaces before the SFCC, this data must be ignored before the IGP/PGL can operate. The Ignore Sequence (IGON/IGOFF) command, discussed on page 88, is provided for this purpose.

Similarly, at times you may also need the IGP/PGL to ignore host- originated paper movement commands (carriage return, line feed, form feed, etc.) in lengthy data streams. Select Format (SFON/ SFOFF), discussed on page 141, is provided for this purpose. In addition, the Quiet command, (page 121), can be used to pass data unchanged to the printer.

Table 3 Execute Form Commands

Command	Mnemonic	Description	Page #
Compressed Print	DENSITY	Defines the horizontal print density in characters per inch (cpi).	52
Dynamic Alphanumeric Data	AF <i>n</i>	Executes the dynamic alphanumeric data provided after the (cc) EXECUTE command.	76
Dynamic Bar Code Data	BF <i>n</i>	Executes the dynamic bar code data provided after the (cc)EXECUTE command.	77
Dynamic Logo	GF <i>n</i>	Executes the dynamic logo data provided after the (cc)EXECUTE command.	78
Expanded Print	EXPAND	Expands fonts vertically and horizontally.	82
Font	FONT	Selects a specific typeface, bold, slant (italic) factor, and symbol set.	83
Hex Sequence On/Off	HEXON HEXOFF	Enables the IGP to interpret all data as hex characters 0-9, A-F. Any data not sent as hex digits is ignored until the HEXOFF command is sent.	88
Ignore Sequence On/Off	IGON IGOFF	Enables the IGP/PGL to ignore all characters after the Ignore Sequence On command is sent until the Ignore Sequence Off command is sent. See Note on page 15.	88
Incremental Alphanumeric Dynamic Data	IAF <i>n</i>	Executes the incremental dynamic alphanumeric data provided after the (cc) EXECUTE command.	80
Incremental Bar Code Dynamic Data	IBF <i>n</i>	Executes the incremental dynamic bar code data provided after the (cc)EXECUTE command.	80
Line Spacing, Vertical	LPI	Defines the lines per inch (lpi) printing format.	89
Multinational Character Set	ISSET	Selects one of the multinational character sets.	Chap. 5
Normal Mode	NORMAL	Places the IGP/PGL in the Normal mode, where it does not change the data stream but awaits the SFCC followed by an IGP/PGL command.	101
Paper	PAPER	Controls printer paper options, such as page orientation, intensity and ribbon use.	103
Reset	RESET	Deletes all forms and logos from the IGP/PGL memory or the printer flash memory.	123
Repeat	REPEAT	Repeats a form a given number of times including all the dynamic data.	122
Select Format On/Off	SFON SFOFF	Ignores all host-generated paper movement commands. See Note on page 15.	141

Alphanumeric Data

Based on the requirements of a specific application, you can use one of three methods to print alphanumeric data on a form: Fixed data, Overlay data, and Dynamic data. These methods are described in more detail in the Commands chapter.

- Fixed data prints on each form in the same “prepositioned” location, unless the location changes in the form definition. Company name, address, logo, and phone number are typical examples of alphanumeric data that can be “fixed” onto the form.
- Overlay data is variable alphanumeric data positioned on the page with line feeds and spaces to fit into exact locations. For example, specific data can be “overlayed” onto a blank form as if you were typing data into the appropriate blanks on a preprinted form. Customer names, addresses, and order numbers are examples of data overlayed onto a form.
- Dynamic data is variable data entered into specific locations on each form. Each time the form prints, a command enters new data in those locations. Customer names, addresses, or any type of variable alphanumeric or bar code data can be provided dynamically.

Incremental Data

The incremental data feature allows you to update alphanumeric and bar code data fields in an alphabetical or numeric manner automatically with just one set of data sent from the host computer.

Alphanumeric and bar code incremental fields can be used with fixed (static) data input as part of the Create Form mode or with dynamic data supplied in the Execute Form mode.

The incremental fields can be increased or decreased, repeated at specified intervals before updating, and reset to the starting value after a specified number of increments.

Configuring The IGP/PGL With The Control Panel

Matching certain printer operational settings to those of the host computer is known as printer configuration. The settings, or configuration parameters, such as selecting the host interface, active emulation, and printer control options, are adjusted according to the printer function switch descriptions in your printer's *Administrator's Manual*. Configure the IGP/PGL in the same way you would configure the printer for other features.

You can select IGP/PGL default parameters directly from the control panel as explained in your *Administrator's Manual*, or by control codes as explained in the Commands chapter. Your *Administrator's Manual* also contains detailed configuration menus and diagrams, as well as descriptions of each configuration parameter available with your printer.

Flash Memory Storage

Flash Memory Utilization

All printers have a certain amount of onboard, non-removable flash memory on the main controller board that can be used for permanent storage. Depending on the application, this Onboard Flash Memory may not be sufficient. Certain models of Printronix printers have an SD card slot. The SD card can be used to extend the range of permanent data storage for applications. For printers with SD capability, the extended range of data storage can be significant (GB).

Since SD capable printers have two storage choices (allowing the same file name to exist on both SD and Onboard Flash Memory), a hierarchy (search order) is required for finding, reading, writing, and deleting files. This hierarchy is described below.

Printers with SD Capability

For printers that support SD files can exist on one or more memory types (SD, Onboard Flash Memory, and DRAM). The parameter **DISK** is used within different PGL commands to select Onboard Flash Memory as the permanent storage location. The parameter **EMC** selects SD card depending on the printer's capabilities. A hierarchy for finding, reading, writing, and deleting files is necessary and is described below.

Read

NOTE: For commands including EXECUTE, LOGO in create mode, PRINT, RECALL, DIRECTORY, FONT, and XML data stream.

Regardless of which parameters are used, all objects are first searched in DRAM.

When an SD card is installed, the printer searches it, along with Onboard Flash Memory regardless of the parameter, EMC and DISK. The search stops at the first occurrence when the file is found. If the file is not found, an error message is printed.

When the SD card is not installed, only DRAM and Onboard Flash Memory are searched.

Write

NOTE: For commands including CREATE, LINK, LOGO in normal mode for PCX and TIFF, SETUP, and FONTLOAD.

Regardless of which parameters are used, all objects are stored in DRAM.

When an SD card is installed, using the parameter EMC will also store the object there. The parameter DISK will either write to Onboard Flash Memory or SD/EMC based on the "Storage Select" front panel menu.

When an SD card is not installed, the parameter EMC will result in an error message. The parameter DISK, however, will write to Onboard Flash Memory regardless of the "Storage Select" menu setting.

Delete

NOTE: For commands including DELETE FONT, DELETE FORM, DELETE LOGO, DELETE LINK, RESET, and OPTIMIZE.

Regardless of which parameters are used, all objects are deleted from DRAM.

When an SD card is installed, the parameter EMC will also delete the file from that location. The parameter DISK deletes the file from either Onboard Flash Memory or SD/EMC based on the "Storage Select" front panel menu.

When the SD card is not installed, the parameter EMC causes an error message to print. The parameter DISK, however, will delete data from Onboard Flash Memory regardless of the "Storage Select" menu setting.

Printers without SD Capability

When the EMC parameter is included with a PGL command, printers without SD capability will access Onboard Flash Memory instead, since the EMC is not supported on these printers.

2 *Commands*

IGP/PGL Command Standards

IGP/PGL commands have many options and a specific format that you must follow to obtain the desired results. Certain elements are standard for all IGP/PGL commands. These command standards are described in the following sections. Familiarize yourself with the meaning and use of these standards before operating the IGP/PGL.

Special Function Control Code (SFCC)

The SFCC identifies a command directed to the IGP/PGL to enable a specific IGP/PGL function. Based on the host computer interface requirements, various characters can be selected as the SFCC, such as the caret (^) or a tilde (~). The SFCC must be placed before a command or data is entered. The examples in this manual use the tilde as the SFCC; always substitute the actual SFCC required by your system wherever the tilde is shown. In the general command formats, the SFCC is represented by (cc).

You can select the SFCC using the CONFIG command (page 45), the Special Function Control Code Change command (page 101) or the control panel (see the *Administrator's Manual*).

Semicolon (;)

Each parameter (alpha data, options, etc.) on the command line is separated by a semicolon. Blank spaces between the semicolon and the next parameter are not allowed. A missing or misplaced semicolon causes an error message.

Uppercase

The IGP/PGL is “case sensitive.” ALL commands must be entered in uppercase.

Inline Commands

The SFCC, usually a “~”, was required to be the first character on a new line. It may now appear anywhere on the command line. There is a configuration option that determines whether any data preceding a command is printed or ignored.

All IGP/PGL commands begin with the Special Function Control Code (SFCC) and end with a valid line terminator. When the command does not end with a valid line terminator, it must end with the SFCC to form an inline command line. This syntax applies only to the commands in Normal mode.

Example:

```
~DIRECTORY~~DELETE LOGO;*ALL~~DIRECTORY
```

Another inline command syntax is to replace the valid line terminator with the inline terminator command (~CR, ~LF, ~FF, or ~LT), and to enclose the entire command line with the SFON/SFOFF command. This syntax applies to all PGL commands.

Example:

```
~SFON~DIRECTORY~LF~DELETE LOGO;*ALL~LF~DIRECTORY~LF~SFOFF
```

The following example is to use no motion line terminator, ~LT, to print two Normal mode texts on the same line with the different font.

```
~SFON~FONT;FACE 93952;POINT 12~LT~FONT;FACE  
92250~LTabcdefg~LT~SFOFF
```

Line Terminator

Each command line must be terminated by a line feed (or a carriage return with a line feed), or a paper motion command. When an inline command is not followed by a valid line terminator, it must also end with the SFCC. The command line will not be accepted if not properly terminated. Refer to your system *Administrator's Manual* for your system keyboard and your printer configuration codes to determine which key(s) (such as ENTER, LINE FEED, RETURN, etc.) perform a line feed, carriage return with line feed, or form feed function.

Printable Character

To print, alphanumeric and bar code data must be enclosed by a printable character (a delimiter). This delimiter is represented by (*D*) in the command format. In this manual, an asterisk (*) is used in most examples as the printable character. (The parentheses are not entered.) Any printable character can be used as this delimiter except a slash (/) or the SFCC. The same printable character must be used at both the beginning and end of the text to be printed and cannot be used within the text.

Spaces

Spaces are used in the general command formats to visually separate individual command parameters. Supply the appropriate information for the command parameter, but do not enter the spaces in the command sequence; they are shown simply as a visual aid to illustrate where one command parameter ends and another begins.

Command Parameters

Most commands include a number of parameters. Some are optional, and some are required. Each parameter must be separated by a semicolon (;) unless noted otherwise. Throughout this manual, actual commands required for input are shown exactly as they must be entered and all parameters associated with that command are shown in italics. Optional parameters are enclosed in brackets [], but do not enter the brackets.

Parentheses indicate variable data. You have a choice of what to enter, but you must enter something. Do not enter the parentheses themselves.

Form Name

You must use alphanumeric characters to identify the document (form or logo) you are creating (a maximum of 15 alphanumeric characters). The Form Name is also used to identify the form during the Execute Form mode. The valid Form Name characters are listed below and also apply to Logo Name. The SFCC can also be used in the Form Name. No spaces are allowed between any of the Form Name characters.

Table 4 Valid Form Name Characters

A through Z (upper and lowercase)	Left and right parentheses ()
0 through 9	Tilde ~
Dollar sign \$	Single quotes ‘ ’
Percent sign %	Exclamation Point !
Dash -	Pound sign #
At sign @	Ampersand &
Left and right braces { }	

Prompt

The prompt is the symbol (e.g., a dollar sign, period or greater than symbol) used to indicate that the host computer is ready for data input. In this manual, the prompt is shown as a period (.).

Numeric Values

In this manual, a lowercase *n* in the command represents a numeric value. If a command parameter includes a lowercase *n*, it must be substituted with an appropriate numeric value. If the lowercase *n* is part of an optional parameter and the option is not selected, a value for *n* is not required.

Comments in Command Lines

To aid in maintenance of a form or logo, comments can be added to many command lines within the CREATE or CREATE LOGO mode. Comments must be preceded by a slash (/). Do NOT use the /comment feature on lines containing an SFCC (e.g., commands used within NORMAL or EXECUTE mode). Throughout this manual, comments are provided in parenthesis beside most command lines for better understanding of IGP/PGL operation but should not be included in your IGP/PGL files. See Form Examples on page 259 for some examples.

Storing Data

To send data to the IGP/PGL, use a system command, such as PRINT. (Entering data through the keyboard does *not* store data in nonvolatile IGP/PGL memory.) Once stored in memory, the data remains until deleted, the IGP/PGL is reset with the RESET command, or until the printer is turned off.

IGP/PGL files can be permanently stored to, deleted from, and retrieved from the Onboard Flash Memory by ending CREATE, CREATE LOGO, DELETE FORM, DELETE LOGO, EXECUTE, and DIRECTORY commands with **;DISK**.

For example, the following command creates a form named ORDER and stores it in the Onboard Flash Memory:

```
(cc)CREATE;ORDER;DISK
```

Executing a form or calling a logo will access the flash memory automatically if the object is not found in RAM.

NOTE: While the printer does not contain a floppy disk drive, the **;DISK** command has been retained to provide backward compatibility with earlier printer models and command syntax.

Uncompressed and Packed Bits Compression

PGL logos support uncompressed and packed bits compression methods. CCITT and LZR (used for color) compression methods are not supported. Refer to your application's documentation about TIFF files.

Character Position.Dot Position (CP.DP) Format

The CP.DP format is a special parameter available with the IGP/PGL commands. CP.DP format allows two elements plotted at nearly the same character location to be offset to eliminate overlapping. Specifying starting and ending rows and columns is its most frequent use.

Each character location is a cell. Each cell is a grid 12 dot rows high by 6 dot columns wide (printing at 6 lpi and 10 cpi). The CP.DP format allows a character cell position (CP) and a specific dot position (DP) within the cell to be identified as shown in Figure 2. The DP portion of the CP.DP format specifies a location down (in reference to rows) and to the right (in reference to columns) within the character cell position.

For example, refer to Figure 2. Suppose a line runs along character position column 13 (CP = 13). At the same time, an alphanumeric string must begin in column 13. With CP.DP format, the alphanumeric string can be offset 2 dot positions (DP = 2) in column 13 to avoid overlap. Specify 13.2 (CP = 13, DP = .2) for the starting column of the alphanumeric string. Similarly, to place a horizontal line 8 dot rows beneath another horizontal line in character row position 11, specify row 11 for one line and row 11.8 for the other line.

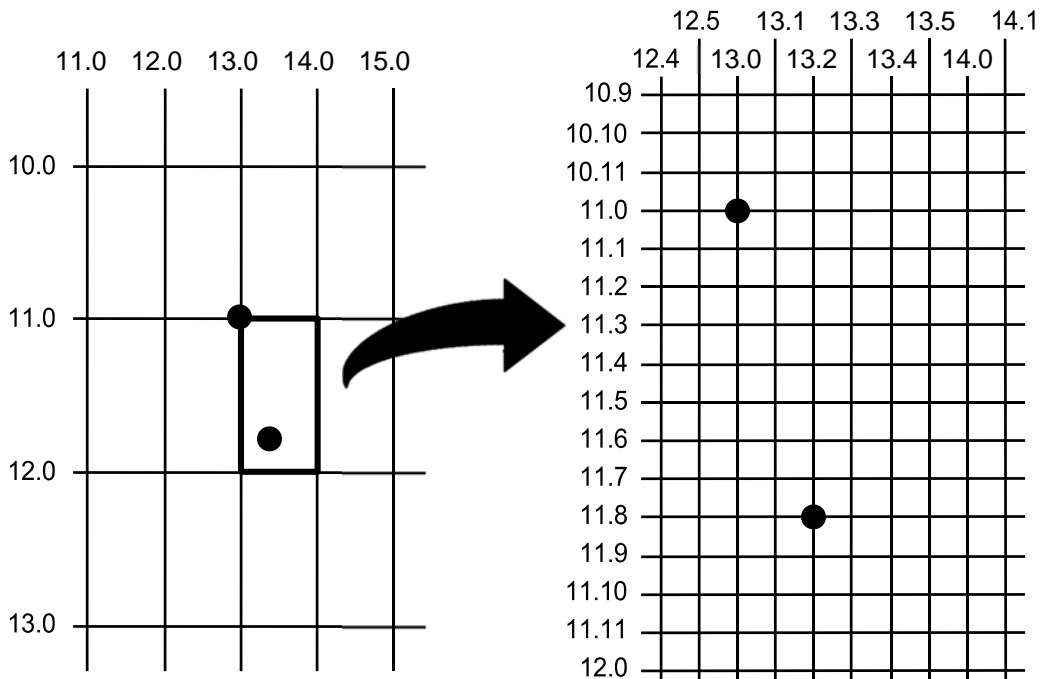

Figure 2 CP.DP Format Example

Command Codes

Data Fields for Alphanumeric and Incremental Data

Based upon the requirements of a specific application, three methods are used to print alphanumeric data on the form: fixed (or prepositioned) data, overlay data, and dynamic data.

Fixed Data

Fixed data is entered during the Create Form mode as part of the form definition. It appears as prepositioned information similar to other form elements. The fixed data is printed on each form in the same location and can only be changed by changing the form definition. Your company's name, address, logo, or phone number are typical examples of alphanumeric data that can be fixed onto the form.

Overlay Data

Overlay data is variable alphanumeric data entered during the Execute Form mode by positioning the information with line feeds and spaces into an exact location. In general, a page of data is overlaid onto a form similar to typing data in the appropriate blanks of a preprinted form. Each page of overlay data is separated by form feeds to correspond to each form printed. Customer names, addresses, and order numbers are examples of variable data that can be overlaid onto the form.

Dynamic Data

Dynamic data is variable data entered by command during the Execute Form mode. The dynamic data is entered into a location previously defined in the Create Form mode. Any number of locations can be identified during the Create Form mode as part of the form definition. A command during the Execute Form mode enters new data in the identified location(s) each time the form prints. Dynamic data is the most efficient method of supplying variable data to the form. Again, customer names, addresses, or any type of logo, variable alphanumeric, or bar code data can be provided dynamically.

Incremental Data Fields

The incremental data fields feature allows alphanumeric (and bar code) data fields to automatically update numerically or alphabetically with just one set of data sent from the host computer. A maximum of 65,535 fields can print with incremental fields automatically updated. Alphanumeric incremental fields can be used with fixed (static) data input as part of the Create Form mode or with dynamic data supplied in the Execute Form mode. Incremental data fields cannot be used with Overlay data.

Alphanumerics

Purpose	Defines and positions alphanumeric data on a “preprinted” static data field or as a dynamic data field.
Mode	CREATE
Format	ALPHA [R;] [E;] [C <i>n</i> ;] [AF <i>n</i> ;L;] [T;] [RJUST; or CJUST;] [NLZ;] [D <i>i</i> R;] [UC;] [DARK;] [POINT;] [HS <i>n</i> ; or HSD <i>n</i> ;] SR; SC; VE; HE; (D) <i>text</i> (D) STOP ALPHA The Alphanumeric command; enter ALPHA . R The optional reverse printing (white on black) parameter. Enter R to specify a black background.

NOTE: The **D** parameter, used in earlier IGP/PGL versions, is ignored in IGP/PGL. In addition, the **L** parameter, also used in earlier IGP/PGL versions to specify a long reverse field for descending characters in dynamic alphanumeric data, is now provided automatically in IGP/PGL. The IGP/PGL ignores these parameters if found in a command line.

E	The optional elongated character parameter. Enter E to specify elongated character printing. Elongated characters are double height and single width. If used, the <i>VE</i> and <i>HE</i> parameters must be set to 0, or an error message will result. Elongated character printing is also available with rotated alphanumerics.
<i>Cn</i>	The optional horizontal compression parameter. Enter C . <i>n</i> = any number between 10 and 30 , specifying the number of horizontal characters per inch (cpi). 10 cpi is the default value. 10A = 10 cpi OCR-A. 10B = 10 cpi OCR-B. If used, the <i>VE</i> and <i>HE</i> parameters must be set to 0, or an error message will result.
AF <i>n</i> ;L	The optional dynamic data field parameters for identifying the alphanumeric string location on a form and for designating the length of the alphanumeric string. If these parameters are used, the actual text cannot be entered during the Create Form mode; it must be entered dynamically during the Execute Form mode. Dynamically entering data during the Execute Form mode permits changes to the alphanumeric text without redefining or re-creating the form. To use this field, perform the following steps: <ol style="list-style-type: none">Enter AF.Replace <i>n</i> with a number ranging from 0 through 512 to identify the alphanumeric string location on the form. The <i>SR</i> and <i>SC</i> parameters are used to specify the exact location of the alphanumeric field identified by <i>n</i>.Replace <i>L</i> with a number equal to the number of characters in the dynamic alphanumeric string ranging from 0 through 255.Dynamically enter the alphanumeric string itself in the Execute Form mode. The length of the alphanumeric string must be equal to or less than the value assigned to the length (<i>L</i>) parameter. Refer to Execute Form: Dynamic Alphanumeric Data on page 61.If the dynamic data field is used, do not enter the <i>text</i> parameter.
T	Optional parameter which truncates the dynamic data field when it exceeds the maximum length defined by the <i>L</i> parameter. When T is not used, a data length error is printed instead.

RJUST	Right text alignment where the starting column (SC) points to the right end of the text string. If RJUST is not specified, the default is left alignment.
CJUST	Center text alignment where the starting column (SC) points to the center of the text string. If CJUST is not specified, the default is left alignment.
NLZ	Suppresses the leading zero.
DIR	Optional parameter for rotating a character string. Use the following codes to indicate the direction of character rotation and to specify an uppercase-only character string: <ul style="list-style-type: none"> a. Enter CW for 90 degree clockwise rotation. b. Enter CCW for 90 degree counterclockwise rotation. c. Enter INV for inverted characters (180 degree rotation). <p>The default orientation prints character strings in the standard horizontal format.</p>

NOTE: Alpha rotation parameters (CW, CCW, INV) require more memory to implement than the default orientation. Thus, characters selected for rotation may appear in the default orientation. Selecting a smaller font will correct the problem.

UC	Enter UC to specify uppercase-only characters. When uppercase-only is specified, all lowercase alpha character codes are converted automatically to uppercase. Consequently, do not specify uppercase-only characters if lowercase characters are required.
DARK	Optional parameter to produce bolder text. Enter DARK or D . (D is also allowed in the ALPHA command only.) More information about dark printing is provided on page 52.
POINT	Optional parameter that changes the units for the vertical and horizontal expansion values. Enter POINT . When the POINT parameter is present the VE value defines the font height in 1/72 of an inch (i.e. points). If the HE value is non-zero, it defines the character width in 1/72 of an inch, otherwise the character width is the standard width for the chosen height. Cannot be used with elongated (E) and compressed (Cn) parameters.
HSn or HSDn	Horizontal Spacing. The value <i>n</i> indicates the number of extra dots to add between each character. <p>HS = the value is in 60 DPI dots</p> <p>HSD = the value is in printer dots.</p> <p>This parameter is used only for proportional fonts.</p>
SR	Defines the starting row of the alphanumeric data. Enter a value ranging from row 1 through one less than the length of the form. Character row or dot row is specified based on the Scale command (page 95), or use the CP.DP format (page 24).
SC	Defines the starting column of the alphanumeric data. Enter a value ranging from column 1 through one less than the width of the form. Character column or dot column is specified based on the Scale command (page 95), or use the CP.DP format (page 24).
VE	Defines the vertical expansion factor to enlarge characters vertically. Enter a value from 0 through 139 . Zero specifies the standard font (no expansion). A VE value must be entered. Use vertical expansion with 12 point font size only. Elongated (E) and compressed (Cn) characters cannot be used with a vertical expansion other than zero.

<i>HE</i>	Defines the horizontal expansion factor to enlarge characters horizontally. Enter a value from 0 through 139 . Zero specifies the standard font (no expansion). An <i>HE</i> value must be entered. Use horizontal expansion with 12 point font size only. Elongated (<i>E</i>) and compressed (<i>Cn</i>) characters cannot be used with a horizontal expansion other than zero.
<i>(D)</i>	The printable character identifying the start and finish of the alphanumeric string. Enter any printable character other than a slash (/), the SFCC, or a character used within the alphanumeric string itself. You must use the same character at both ends of the alphanumeric string, but it will not print with the data.
<i>text</i>	The group of ASCII characters (the alphanumeric string) to print. Enter any of the standard ASCII printable characters (except the character used to delimit the string in the <i>(D)</i> parameter). The data appears as “prepositioned” information on the form beginning at the location specified by <i>SR</i> and <i>SC</i> . This is the “fixed” or static alphanumeric data; once defined on the form, it is changed only by redefining the form using the Alphanumerics command. When DBCS character set is selected by ISET or SYMSET, and DBCS font is selected by FONT NAME, DBCS data will print.
STOP	Stop indicates the end of the Alphanumeric command; enter STOP , and the IGP/PGL will wait for a new command. If not entered, the IGP/PGL will wait for another set of Alphanumeric command parameters.

Comments

As dynamic data, the location of the alphanumeric field is established in the Create Form mode and the actual alphanumeric data is continuously redefined before placement on the form in the Execute Form mode. You can also rotate and reverse print the alphanumeric string using this command.

Example

The following program and example in Figure 3 illustrates the Alphanumeric command capabilities. To illustrate positioning, starting row and column are indicated on the example but do not necessarily reflect actual location on the page. Notice the same starting row is used for all “EXAMPLE” characters, and they are all aligned on the same baseline (or bottom), regardless of expanded or compressed parameters. The string rotates around the point of intersection of the starting row and columns shown by the “pinwheel” E. A rotated 10 cpi character establishes the baseline for all character sizes.

```

ALPHA 36;37;4;4;*E*
36;41;2;3;*X*
36;44;2;2;*A*
36;46;1;1;*M*           (Single-size character, expanded font)
C13;36;47;0;0;*P*
C15;36;48;0;0;*L*
C17;36;49;0;0;*E*
CW;36;60;2;2;*CLOCK*
CW;42;60;4;4;*WISE*
CCW;58;26;2;3;*COUNTER*
CCW;45.5;26;2;2;*CLOCK*
CCW;39.2;26;1;1;*WISE*
INV;54.5;58;0;0;*INVERTED*
R;INV;54.5;49;0;0;*REVERSE PRINT*
45;48;0;0;*E*
CW;UC;45;48;0;0;*e*     (Lowercase converted to uppercase)
CCW;45;48;0;0;*E*
INV;45;48;0;0;*E* STOP

```

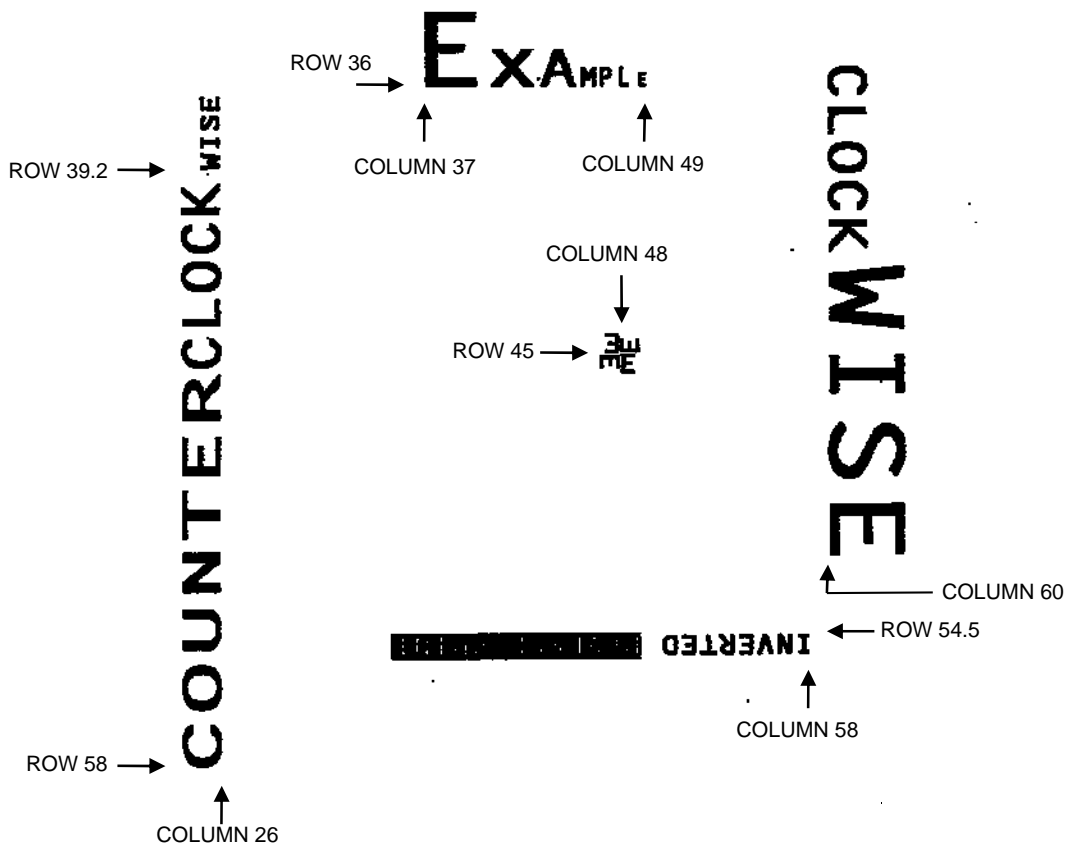

Figure 3 Alphanumeric Example

Alphanumerics, Incremental Fields

Purpose The incremental fields feature updates alphanumeric (and bar code) data fields in a numeric or alphabetical manner automatically using just one set of data sent from the host computer. Incremental alphanumeric data fields can be applied to fixed (static) data (page 34), or dynamic data (page 36).

Mode CREATE (for fixed data) or EXECUTE (for dynamic data)

NOTE: Throughout the discussion of incremental fields, the term “increment” or “incremental” means the field is automatically updated by a specified amount (or increment). The field can actually be increased/decreased in specified increments/decrements within the command.

Comments

Incremental fields can increase or decrease, repeat at specified intervals before updating, and reset to the starting value after a specified number of increments. A maximum of 65,535 fields can be defined.

Using Incremental Alphanumeric Data

Incrementing is controlled with the STEPMASK and STARTDATA command parameters as described in Table 5. The parameters are part of the Incremental Alphanumeric Fixed Data command or part of the Execute command when using incremental alphanumeric dynamic data.

The STEPMASK parameter performs the following three functions:

1. It defines the increment amount (step);
2. It defines the number of characters allowed in the data field (STARTDATA); and
3. It provides a “mask” to link or unlink subfields of the data to be incremented independently. The data provided in the STEPMASK field combined with the data in the STARTDATA field determine the result of these functions.

The increment amount is defined by the numeric value of the STEPMASK data. For example, a STEPMASK value of 1 increments the STARTDATA by 1; a STEPMASK value of 2 increments the STARTDATA by 2.

The maximum number of characters allowed in the STARTDATA field is defined by the number of characters in the STEPMASK field; the STARTDATA field cannot contain more characters than used in the STEPMASK field.

Linked and unlinked masking of subfields within the STARTDATA is defined by the **L** value in the STEPMASK field. **L** indicates linked but non-incremental data in the corresponding position of the STARTDATA field; any alpha character other than **L** in the STEPMASK field indicates a non-incremental, non-linked STARTDATA subfield.

Table 5 Increment Alphanumeric

STEPMASK	START DATA	Character Type and Function
0 - 9	A - Z	Alpha characters incremented by amount in STEPMASK field
0 - 9	0 - 9	Numeric characters incremented by amount in STEPMASK field
0 - 9	Space	Same character type as character in the next right adjacent, linked increment position. Character type will be numeric if in least significant position.
0 - 9	Not A - Z or 0 - 9	Error
Not 0 - 9 or L	Any	Non-incrementing alphanumeric character
L	Any	Linked, non-incrementing alphanumeric character

The examples on the following pages illustrate incremental alphanumeric data fields. All cases in the examples use a repeat count parameter value of 1 and a reset count parameter value of 0. The three vertical dots illustrate the natural progression for each column and unit of data based on the incremental count and its impact on linked and unlinked data fields.

	Value	Description
STARTDATA:	ABC123	Linked subfields: ABC and 123 RPT = 1 RST = 0
STEPMASK:	000001	
Printed Results:	ABC123	
	ABC124	
	
	
	
	ABC999	
	ABD000	
	
	
	
	ZZZ999	
	AAA000	

	Value	Description
STARTDATA:	1ABC123	Two separate but linked numeric subfields: 1 and 123, while fixed data ABC is non-incrementing
STEPMASK:	0LLL001	
Printed Results:	1ABC123 1ABC124 · · · · · · · · · 1ABC999 2ABC000	RPT = 1 RPT = 0

	Value	Description
STARTDATA:	ABC123	Two separate unlinked subfields: ABC and 3, while fixed data 1 and 2 is non-incrementing
STEPMASK:	001XX1	
Printed Results:	ABC123 ABD124 · · · · · · ABI129 ABJ120	RPT = 1 RPT = 0

	Value	Description
STARTDATA:	<u> </u> 1	Single numeric field with leading spaces ()
STEPMASK:	0001	
Printed Results:	<u> </u> 1 <u> </u> 2 · · · · · · · · · <u> </u> 10	RPT = 1 RPT = 0

	Value	Description
STARTDATA:	<u> </u> AA98	Two separate but linked numeric subfields: AA and 98, with leading space (); fixed data AA is non-incrementing
STEPMASK:	0LL01	
Printed Results:	<u> </u> AA98 · · · · · · · · · 1AA00	RPT = 1 RST = 0

	Value	Description
STARTDATA:	_42AR	Two separate but linked alpha subfields: A and R, with leading space (_); fixed data 42 is non-incrementing
STEPMASK:	0LL01	
Printed Results:	<hr/> _42AR _42AS42ZZ A42AA	RPT = 1 RST = 0

	Value	Description
STARTDATA:	9AA02	Single numeric field decremented by 1, while fixed data 9 and AA are non-incrementing.
STEPMASK:	-XXX01	
Printed Results:	<hr/> 9AA02 9AA01 9AA00 9AA99 9AA03	

Alphanumerics, Incremental: Fixed Data Fields

Purpose To automatically increment/decrement fixed alphanumeric data fields.

Mode CREATE

NOTE: In the command format below, incremental alphanumeric command parameters are shown in **boldface** type; standard alphanumeric command parameters and optional non-incremental parameters are shown in *italics*. Due to space constraints, the command parameters are separated into two lines. During actual IGP/PGL input, DO NOT separate command parameters.

Format ALPHA

*[R;] [E;] [Cn;] I; [DIR;] [UC;] [DARK;] [POINT;] [HSn or HSDn;] SR; SC; VE; HE; [**idir**]
STEPMASK; [RPTn;] [RSTn;] (D)STARTDATA(D)*

STOP

I Identifies this alphanumeric command as an Incremental Alphanumeric command; enter **I**.

idir The optional increment direction parameter to specify an increment (add) or decrement (subtract) to the data. Enter a plus sign (+) or leave the field blank to increment (the default). Enter a minus sign (-) to decrement.

STEPMASK Defines the increment amount (step), the number of character positions in the data field, and provides a mask to control the increment function on specific parts of the data. Enter the appropriate value. Refer to Table 5 on page 31 for complete information on STEPMASK parameter values.

RPTn The optional incremental repeat count parameter to specify the number of times a particular field value is repeated before it is incremented. A repeated field value is useful when printing multiple rows/columns of identical labels before increasing to the next value.

To use the repeat count parameter, enter **RPT** and replace *n* with a numeric value ranging from **1** through **65535** to specify the repeat count. The default repeat count parameter is 1, which will increment the field value each time it prints.

RSTn The optional incremental reset count parameter to specify the number of times an incremented field is printed (on one or more forms) before it is reset to the starting value. A reset count is useful when printing a hierarchy of fields where a low-level field generates a sequence of numbers, is reset, and the next higher field level is incremented (such as in a unit/box/carton application). To use the reset count parameter, enter **RST** and replace *n* with a number ranging from **1** through **65535** to specify the reset count. The default reset count value is 0.

STARTDATA Defines the starting value of the incrementing field. Enter the appropriate value. Refer to Using Incremental Alphanumeric Data on page 30 for complete information on STARTDATA and STEPMASK parameter values.

The maximum amount of STARTDATA characters must be equal to or less than the number of characters in the STEPMASK field. If the number of data characters is less than the number used in STEPMASK, the data will print right justified with preceding spaces. Characters allowed for incrementing fields (STEPMASK values of 0 - 9) are numeric 0 - 9 and alpha A - Z (uppercase only). Any printable character is allowed in non-incrementing fields (STEPMASK values not 0 - 9). The STARTDATA must be enclosed within standard printable character

delimiters just as a standard alphanumeric data field is enclosed within delimiters.

Comments

The Incremental Alphanumeric Fixed Data Fields command is a revised version of the standard IGP/PGL alphanumeric command, but it does not replace the standard alphanumeric command.

```
~CREATE;TEST;288          (Enters Create Form mode)
VDUP;3;6                 (Repeat alpha string)
ALPHA                    (Alpha command)
I;6;5;4;4;-00001;*12345*
STOP                     (Ends Alpha command)
VDUP;OFF
END                      (Terminates Create Form mode)
~EXECUTE;TEST            (Prints form)
~NORMAL
```

12345

12344

12343

Alphanumerics, Incremental: Dynamic Data Fields

Purpose Automatically increments/decrements dynamic alphanumeric data fields. Specifies the location and size of the incremental dynamic data field during the Create Form mode; STEPMASK and STARTDATA parameters are supplied in the Execute command during the Execute Form mode.

Mode CREATE

NOTE: In the command format below, incremental alphanumeric command parameters are shown in **boldface** type; standard alphanumeric command parameters and optional non-incremental parameters are shown in *italics*.

Format ALPHA

*[R;] [E;] [Cn;] **IAFn;L;**[T;] [DIR;] [UC;] [DARK;] [POINT;] [HSn or HSDn;] SR; SC; VE; HE
STOP*

IAFn;L Identifies this alphanumeric command as an Incremental Alphanumeric Dynamic Data Field command. The command parameter string identifies the incremental dynamic data field location on the form and defines the length of the alphanumeric data. If these parameters are used, the STEPMASK and STARTDATA parameters cannot be entered in the Create Form mode; they are entered dynamically during the Execute Forms mode. To use the incremental dynamic data field, perform the following steps:

- a. Enter **IAF** to specify an incremental alphanumeric dynamic data field.
- b. Replace *n* with a number ranging from **0 through 512** to identify the alphanumeric string location on the form. The standard alphanumeric *SR* and *SC* command parameters specify the exact location of the field identified by *n*.
- c. Replace *L* with a number equal to the number of characters in the dynamic alphanumeric string (STARTDATA) ranging from **1 through 255**.
- d. Dynamically enter the STEPMASK and STARTDATA parameters in the Execute Form mode. The length of the data must be equal to or less than the value assigned to the length (*L*) parameter. Refer to Execute Form: Incremental Dynamic Data on page 63 for more information.

Comments

The Incremental Alphanumeric Dynamic Data Fields command is a variation of the standard IGP/PGL Alphanumeric command, but does not replace the standard alphanumeric command.

As with standard dynamic data fields, incremental dynamic data fields allow the starting data to be changed without changing the form definition program. Increment parameters can also change with each new job without changing the form definition program.

Duplicating Incremental Alphanumeric Fields — Incremental alphanumeric fixed and dynamic data fields are duplicated horizontally using the HDUP command and vertically using the standard VDUP command. Duplicated incremental fields increment in left-to-right, top-to-bottom order. The following examples illustrate the results of duplicated incremental fields.

	Value	Description
STARTDATA:	01	<i>Single numeric field (01)</i>
STEPMASK:	01	
Printed Results:		<i>RPT = 1</i>
		<i>RST = 0</i>
		<i>HDUP = 3</i>
		<i>VDUP = 2</i>
<i>Page #1:</i>	01 02 03	
	04 05 06	
<i>Page #2:</i>	07 08 09	
	10 11 12	

	Field A	Description
STARTDATA:	A01	<i>Unlinked subfields, alpha (A), numeric (01)</i>
STEPMASK:	X01	
		<i>RPT = 3</i>
		<i>RST = 9</i>
		<i>HDUP = 3</i>
		<i>VDUP = 3</i>
	Field B	
STARTDATA:	B01	<i>Unlinked subfields, alpha (B), numeric (01)</i>
STEPMASK:	X01	
		<i>RPT = 1</i>
		<i>RST = 0</i>
		<i>(No HDUP or VDUP)</i>
<i>Page #1:</i>	A01 A01 A01 B01	
	A02 A02 A02	
	A03 A03 A03	
<i>Page #2:</i>	A01 A01 A01 B02	
	A02 A02 A02	
	A03 A03 A03	

Example

The following program will produce the Incremental Alphanumeric data example above. The program elements are also defined. (Refer to the command format on page 34.)

```
ALPHA
I;1;1;0;0;001;RPT3;RST9;*A01*
I;3;1;0;0;001;RPT1;RST0;*B01*
STOP
```

where:

```
I;1;1;0;0;001;RPT3;RST9;*A01*
```

- Incremental alphanumeric command;
- SR of 1; SC of 1;
- VE and HE are 0;
- 001 stepmask increments by 1;
- RPT3 repeats each field value 3 times;
- RST9 prints and increments each field 9 times before resetting;
- * identifies the start and finish of the alphanumeric string;
- A01 is the starting value.

I;3;1;0;0;001;RPT1;RST0;*B01*

Incremental alphanumeric command;

SR of 1; SC of 1;

VE and HE are 0;

001 stepmask increments by 1;

RPT1 repeats each field value once;

RST0 prints and increments each field 0 times before resetting;

* identifies the start and finish of the alphanumeric string;

B01 is the starting value.

~CREATE;TEST;288	(Enters Create Form mode)
VDUP;3;6	(Repeats alpha string)
ALPHA	(Alpha command)
IAF1;5;6;5;4;4	
STOP	(Ends Alpha command)
VDUP;OFF	
END	(Terminates Create Form mode)
~EXECUTE;TEST	(Prints form)
~IAF1;+00002;*45678*	
~NORMAL	

45678

45680

45682

Boxes

Purpose Produces any variety of rectangular boxes.

Mode CREATE

Format BOX *LT;SR;SC;ER;EC;RD* STOP

BOX	The Box command; enter BOX . Boxes expand down and to the right from the given row and column.
<i>LT</i>	Defines the line thickness, measured in dots. Line thickness is based on dot dimensions of 1/72" both horizontally and vertically, so that line thickness is equal in both directions. Enter a value of 1 or greater.
<i>SR</i>	Defines the starting row of the box. Enter a value ranging from row 1 through one less than the length of the form. Character row or dot row in millimeters is specified based on the Scale command (page 95), or use the CP.DP format (page 24).
<i>SC</i>	Defines the starting column of the box. Enter a value ranging from column 1 through one less than the width of the form. Character column or dot column in millimeters is specified based on the Scale command (page 95), or use the CP.DP format (page 24).
<i>ER</i>	Defines the ending row of the box. Enter a value ranging from row 2 through the last row of the form. The ending row must be greater than the starting row. Character row or dot row in millimeters is specified based on the Scale command (page 95), or use the CP.DP format (page 24).
<i>EC</i>	Defines the ending column of the box. Enter a value ranging from column 2 through the last column of the form. The ending column must be greater than the starting column. Character column or dot column in millimeters is specified based on the Scale command (page 95), or use the CP.DP format (page 24).
<i>RD</i>	Optional parameter. Defines the degree of corner-rounding. Accept values from 0 (no rounding) to 8 (heaviest rounding). The default value is 0. This option is currently applicable for non-impact printers only.
STOP	Stop indicates the end of the Box command; enter STOP , and the IGP/PGL will wait for a new command. If not entered, the IGP/PGL will wait for another set of Box command parameters.

Example

The following program and example in Figure 4 defines two boxes. To illustrate positioning, the starting row and column are indicated on the example but do not necessarily reflect actual location on the page. (Note the position of the ending row and column; line thickness is not included.)

```
BOX
3;24;16;51;63          (One box three dot rows
thick) 2;44;48;46;58    (One box two dot rows thick)
STOP
```

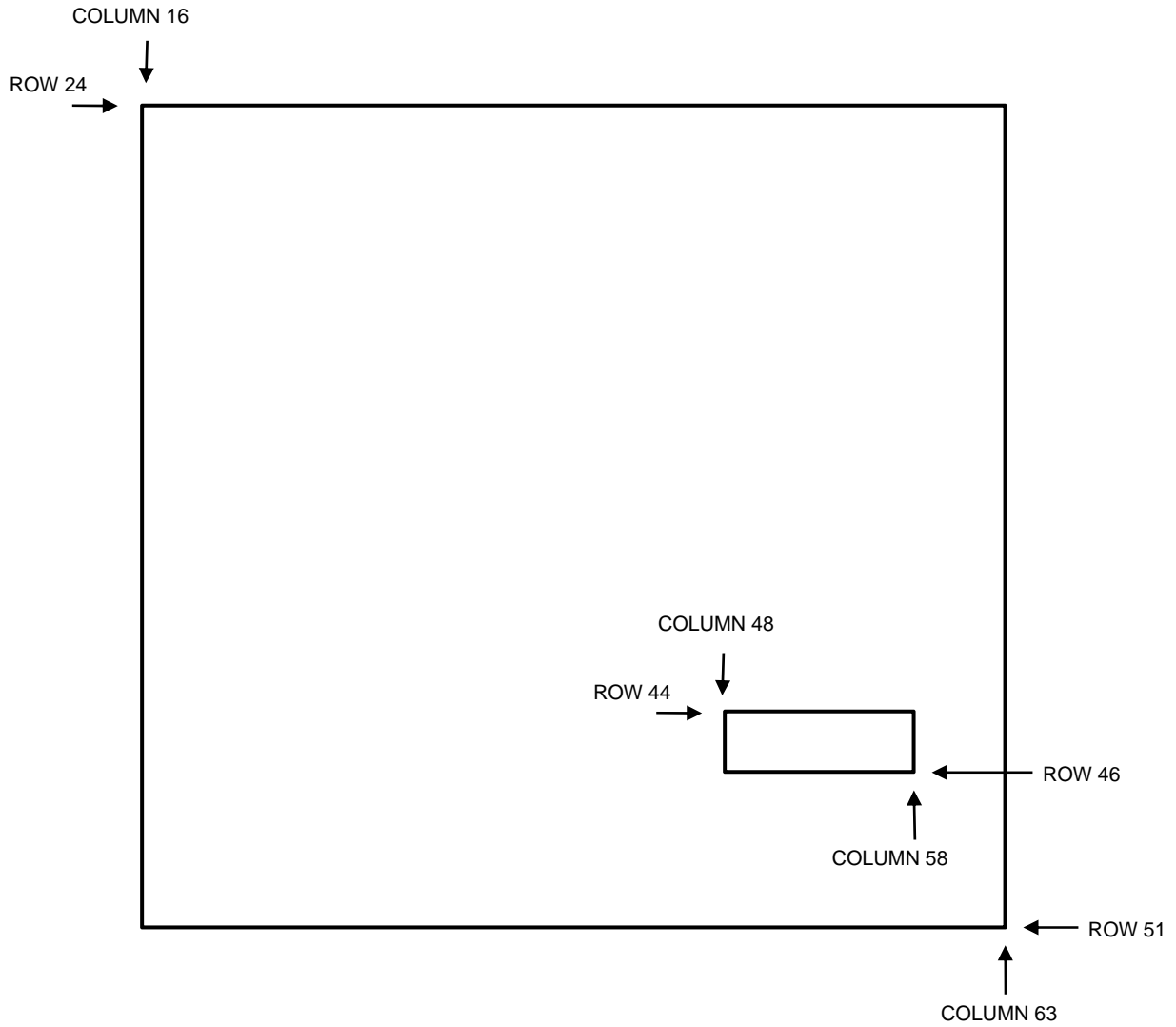
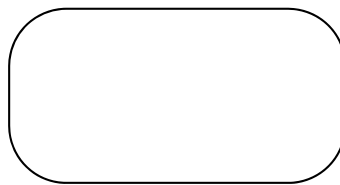

Figure 4 Box Example



```

~CREATE ; X Y Z :432
BOX
2:5:5:10:20:5
STOP
END
~EXECUTE ;X Y Z

~NORMAL

```

Cancel

Purpose To cancel the print job immediately when the command is sent to the printer. When received, printing will stop and any data received prior to the CANCEL command will be cleared from the buffers.

Mode NORMAL

Format (cc) CANCEL
(cc) The Special Function Control Code.
CANCEL The cancel command. Enter CANCEL.

Comment

1. The cancel command will take effect only when a snooper (preparser) is enabled. Any of the following commands will enable the snooper for all ports. You can also enable preparser by using the front panel. Send the following command to the printer before sending the job.

```
~CONFIG  
SNOOP;CANCEL;PAR  
END
```

```
~CONFIG  
SNOOP;CANCEL;ETH  
END
```

```
~CONFIG  
SNOOP;CANCEL;SER  
END
```

The CANCEL command works if it is received from any port. PAR, ETH, and SER are listed as compatible with old PGL commands.

To disable a snooper, send the following command to the printer before sending the job.

```
~CONFIG  
SNOOP;OFF  
END
```

2. After the snooper is enabled, the cancel command can be sent to the printer during the print job through any port.

Example

The following example shows the format of cancel command.

```
~CANCEL
```

Circle

Purpose	Produces a circle on the printed table.
Mode	CREATE
Syntax	CIRCLE LT; SR; SC; DA STOP
CIRCLE	The Circle command.
LT	Defines the border thickness, measured in vertical IGP dots (1/72 inch increments).
SR	Defines the starting row of the circle (CP.DP format, dot rows, or direct measurement in millimeters based on the SCALE command).
SC	Defines the starting column of the circle (CP.DP format, dot rows, or direct measurement in millimeters based on the SCALE command).
DA	Defines circle diameter, measured in vertical IGP dots. Circle diameter is based on dot dimensions of 1/72 inch both horizontally and vertically. The circle diameter is equal in both directions. Enter a value greater than the border thickness.

NOTE: The CIRCLE command is currently applicable for non-impact printers only.

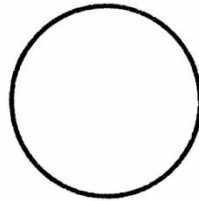

```
~CREATE : XYZ : 432  
CIRCLE  
2 : 5 : 5 : 72  
STOP  
END  
~EXECUTE : XYZ  
  
~NORMAL
```

Figure 5 Circle Example

Compressed Print (Density)

Purpose	Defines the horizontal print density in characters per inch (cpi).
Mode	NORMAL, EXECUTE
Format	(cc) DENSITY; <i>n</i>
(cc)	The Special Function Control Code.
DENSITY	The Density command; enter DENSITY .
<i>n</i>	Selects the density in cpi, OCR-A, or OCR-B; enter a value of 10 , 12 , 13 , 15 , 17 or 20 to specify the density in characters per inch (the default is 10 cpi), or 10A to select 10 cpi OCR-A or 10B to select 10 cpi OCR-B.

Comments

Print density formats of 10, 12, 13, 15, 17 or 20 cpi are available. If you need to print at 30 cpi, use the Alphanumeric command *Cn* parameter, as described on page 26. Standard print density is 10 cpi. After a Density command is entered, all subsequent alphanumeric print at the specified density until another Density command, a Normal mode command, or a Reset command is entered. The Density command also permits the standard printer editing function (carriage return editing). After the Density command is entered, data in the print buffer can be edited as described in your printer *Administrator's Manual*.

Example

The following command selects 15 cpi printing format until another Density command, a Normal mode command, or a Reset command is entered.

```
~DENSITY;15
```

Clock Element Format

Purpose	Embeds Realtime Clock information in an ALPHA and/or BARCODE data field.
Format	<CI><SIGN><OFFSET><DOT or COMMA><TYPE>
<CI>	The Clock Indicator character, as defined by the CLOCK parameter in the ALPHA and/or BARCODE commands. See the ALPHA and BARCODE command descriptions for details.
<SIGN>	Sign for the offset, can be "+" to add or "-" to subtract.
<OFFSET>	Offset to the selected clock type. This is an amount of time to add to or subtract from the selected clock element value. Also referred to as "Sell-By" Date.
<DOT or COMMA>	The "." character indicates that this sequence will be printed, and the given offset will be used. The comma (,) indicates that this sequence will not be printed. It will only be used to specify the offset.
TYPE	The clock element to display. See Table 6 for available elements.

Table 6 Clock Element Types

Type	Description	Range
d	Day of the month	01..31
n	Month number	01..12
M	Full Month name	January..December
A	Abbreviated month name	Jan..Dec
y	2-digit Year number	00..99
Y	4-digit Year number	0000..9999
h	Hour, 12hr clock	01..12
H	Hour, 24hr clock	00..23
p	AM/PM designation	AM/PM
m	Minute	00..59
s	Second	00..59

When the CLOCK parameter is not specific in the BARCODE/ALPHA command, the Clock Format is treated as text.

The offset is the total of all offsets in the data field.

Adding months or years that result in days beyond the end of the new month will roll over into the following month. For instance, adding one year to Feb 29 will result in Mar 1st. Or, adding 1 month to Jan 31 2002 will result in Mar 3. (Jan 31 + 1 Month = Feb 31, Feb 2002 only has 28 days).

NOTE: By default, the time stamp on the label reflects the time the label (bitmap page) is drawn, not the time when the label prints from the engine. As a result, there is a time lapse between when the label is drawn and when the label is printed. Only in Tear Off and Peel Off mode does the time stamp on the label reflect the time when the label is printed by the engine.

Example

```

~MONTH;F (define a new name for January)
____JANUARY_ (the rest of the months use default)
END
~CREATE;CLOCK;0
ALPHA
CLOCK%;AF1;60;3;2;1;1 (these Dynamic Alpha fields will)
CLOCK%;AF2;60;4;2;1;1 (be scanned for Clock data)
CLOCK%;AF3;60;5;2;1;1 (which must start with a % sign)
STOP
END
(Set clock to Jan/31/2002, 23 hr, Minutes & Seconds don't change)
~SETCLOCK;DA 31;MO 01;YE 2002;HO 23;
~EXECUTE;CLOCK
~AF1;*Today = %+0.M / %+0.d / %+0.Y*
(Add 1 Hr to current time, but don't print the hours)
~AF2;*1 Hr later = %+0.M / %+0.d / %+0.Y %+1.H* (Add 1 month)
~AF3;*1 Month Later = %+1.A / %+0.d / %+0.y*

```

Result

Today = ____JANUARY_/31/2002
1 Hr Later = February / 01 / 2002
1 Month Later = March / 03 / 02

Configuration

Purpose Places the IGP/PGL in the Configuration mode, where changes to any or all of the IGP/PGL configuration parameters via software control can be made instead of from the printer control panel.

Mode NORMAL

NOTE: A separate line is required for the CONFIG command, the parameters and values, and the END command.

Format (cc)CONFIG
parameter, value
END

(cc) The SFCC.

CONFIG The Configuration command; enter **CONFIG**.

parameter, value

The parameter for which a configuration change is desired, and the value associated with that parameter. The available parameters and the values associated with these parameters are listed in **Error! Reference source not found.**

END Terminates the CONFIG command; enter **END**.

NOTE: All CONFIG parameters except RESET must be followed by a semicolon (;). Any CONFIG parameters not entered in UPPERCASE and exactly as listed in **Error! Reference source not found.** will result in an Error 156. (Refer to the Error Codes chapter.)

Checkmarked cells in **Error! Reference source not found.** means full compatibility for all applicable models in the line matrix line. If the column is left blank, the command is ignored for the given product line. If individual models are listed, the commands are supported only on those listed models.

Table 7 Configuration Parameters

Configuration Parameter	Value	LM
AI 00 SPACES	0 = Disabled; Non-Zero = Enabled	✓
AUTO EJECT	0 = Disabled; Non-Zero = Enabled	✓
AUTO WRAP	0 = Disabled; Non-Zero = Enabled	✓
BLOCK FONTS	0 = Disabled; Non-Zero = Enabled	✓
BOUNDARY CHECK	0 = Disabled; Non-Zero = Enabled	✓
C39 COMPATBL	0 = Disabled; Non-Zero = Enabled	✓

Table 7 Configuration Parameters

Configuration Parameter	Value	LM
CARRIAGE RETURN DEF	0 = Disabled; Non-Zero = Enabled	✓
CHECK DYNAMIC BCD	0 = Off; 1=On	✓
COMPRESSED CPI	0 = Disabled; Non-Zero = Enabled	✓
CR EDIT	0 = Disabled; Non-Zero = Enabled	✓
DISK STORAGE	0 = Onboard Flash Memory 1 = Expanded Memory Cartridge or SD	✓
ERROR REPORT	0 = Off; 1 = On	
ERROR REPORT	0 = Off; 1 = On; 2 = Debug; 3 = Fault	✓
EXT EXECUTE COPY	0 = Disabled; Non-Zero = Enabled	✓
FF AT TOF	0 = Disabled; Non-Zero = Enabled	✓
FORM HANDLING	0 = Disabled; 1 = Auto eject; 2 = Auto TOF	✓
HANGUL	0 = Disabled; Non-Zero = Enabled	Hangul
HOST FORM LENGTH	0 = Disabled; Non-Zero = Enabled	✓
I-2/5 SELECTION	1 = Trailing Spaces 2 = X2DPD 3 = Modulo 7 CD any other value = Leading Zero	✓
IGNORE CHAR	0-255 = the selected ignore char; any other value = ignore mode off	✓
IGNORE TEXT	0 = Disabled; Non-Zero = Enabled	✓
IGP100 COMPATBL	0 = Disabled; Non-Zero = Enabled	✓
LINE FEED DEF	0 = Disabled; Non-Zero = Enabled	✓
LPI	1-1000	✓
LEFT MARGIN	Horz. IGP Dots (60 dpi)	✓
OPTIMIZED RATIO	0 = Disabled; Non-Zero = Enabled	✓

Table 7 Configuration Parameters

Configuration Parameter	Value	LM
PGL NORMAL	0 = Disabled; Non-Zero = Enabled	✓
POWER ON IGP/PGL	0 = Disabled; Non-Zero = Enabled	✓
POWER ON S-MODE	0 = Disabled; 1, 2, 3, 4, 5 for different printer mode (refer to the table for printer mode)	✓
PRINT QUALITY	0 = Data Processing; 1 = High; 2 = Best	✓
PRINTER PI LINE	0 = Disabled; Non-Zero = Enabled	✓
PRINTER TYPE	0 = Disabled; Non-Zero = Enabled	✓
REPEAT FORM OPT	0 = Disabled; Non-Zero = Enabled	
RESET	N/A	✓
SFCC	1-255	✓
SLEW RANGE	0 = 15; Non-Zero = 16	✓
SKIP PREFIX	0 = Disabled; Non-Zero = Enabled	✓
SLASH ZERO	0 = Disabled; Non-Zero = Enabled	✓
SNOOP	“STATUS” or “CANCEL” = Enabled “OFF” = Disabled	
SO CHAR	0 - 255	✓
TOP/BOTTOM MARGIN	Vert. IGP Dots (72 dpi)	✓
TRUE FORM SLEW	0 = Disabled; Non-Zero = Enabled	✓
TRUNC DYN DATA	0 = Disabled; Non-Zero = Enabled	✓
UPC DESCENDERS	0 = Disabled; Non-Zero = Enabled	✓
UPPERCASE	0 = Disabled; Non-Zero = Enabled	✓
UPCASE DOT 0	0 = Disabled; Non-Zero = Enabled	✓
USER-DEF RATIO	0 = Disabled; Non-Zero = Enabled	✓
VAR FORM ADJUST	0, 1, ..., 30	✓

Table 7 Configuration Parameters

Configuration Parameter	Value	LM
VAR FORM TYPE	0 = Add Nothing 1 = Add 2 = Add; X	✓

Comments

The IGP/PGL configuration parameters available are defined in your *Administrator's Manual*.

Any or all parameters can be used within one CONFIG command, and they can be listed in any order. List each *parameter,value* on a separate line, terminating with the END command. Default configuration values can be reset using the CONFIG command.

Parameters not followed by a value, and parameters followed by any non-zero value are interpreted as "true" or "enabled" values. For carriage return and line feed definitions, a zero value does not change the data stream. However, for non-zero values, a carriage return character or line feed character will be interpreted as a carriage return plus a line feed.

Parameters not listed in this command remain unchanged. If a parameter error is detected for parameters other than 0 or 1 (i.e., SFCC, Top/Bottom Margin, Left Margin), the value will default to the current configuration from flash memory.

Example 1

The following command enables IGP/PGL Auto Wrap, disables Auto Eject, and selects 6 lpi printing.

```
~CONFIG  
AUTO WRAP;1  
AUTO EJECT;0 LPI;6  
END
```

Example 2

The following command resets all control panel IGP/PGL configuration parameters back to default values.

```
~CONFIG  
RESET  
END
```

Corners

Purpose	Defines corner sets.
Mode	CREATE
Format	CORNER <i>LT;SR;SC;ER;EC;VL;HL</i> STOP
CORNER	The Corner command; enter CORNER . Corners expand down and to the right from the given row and column.
<i>LT</i>	Defines the line thickness, measured in dots. Line thickness is based on dot dimensions of 1/72" both horizontally and vertically, so that line thickness is equal in both directions. Enter a value of 1 or greater.
<i>SR</i>	Defines the starting row of the corner. Enter a value ranging from row 1 through one less than the length of the form. Character row or dot row in millimeters is specified based on the Scale command (page 95), or use the CP.DP format (page 24).
<i>SC</i>	Defines the starting column of the corner. Enter a value ranging from column 1 through one less than the width of the form. Character column or dot column in millimeters is specified based on the Scale command (page 95), or use the CP.DP format (page 24).
<i>ER</i>	Defines the ending row of the corner. Enter a value ranging from row 2 through the last row of the form. The ending row must be greater than the starting row. Character row or dot row in millimeters is specified based on the Scale command (page 95), or use the CP.DP format (page 24).
<i>EC</i>	Defines the ending column of the corner. Enter a value ranging from column 2 through the last column of the form. The ending column must be greater than the starting column. Character column or dot column in millimeters is specified based on the Scale command (page 95), or use the CP.DP format (page 24).
<i>VL</i>	Defines the length of the vertical arm (including the line thickness) of each corner in the set. Enter a value of 1 or greater specified in character or dot rows based on the Scale command (page 95), or use the CP.DP format (page 24).
<i>HL</i>	Defines the length of the horizontal arm (including the line thickness) of each corner in the set. Enter a value of 1 or greater specified in character or dot columns based on the Scale command (page 95), or use the CP.DP format (page 24).
STOP	Stop indicates the end of the CORNER command; enter STOP , and the IGP/PGL will wait for a new command. If not entered, the IGP/PGL will wait for another set of Corner command parameters.

Example

The following program specifies a corner set as shown in Figure 6. To illustrate positioning, the starting row and column are indicated on the example but do not necessarily reflect actual location on the page. (Note the position of the ending row and ending column; they do not include the line thickness.)

```
CORNER
5;27;27;42;55;4;6      (Each corner in the set is 5 dot rows
STOP                   thick, 4 character rows high, 6 character
                       columns wide)
```

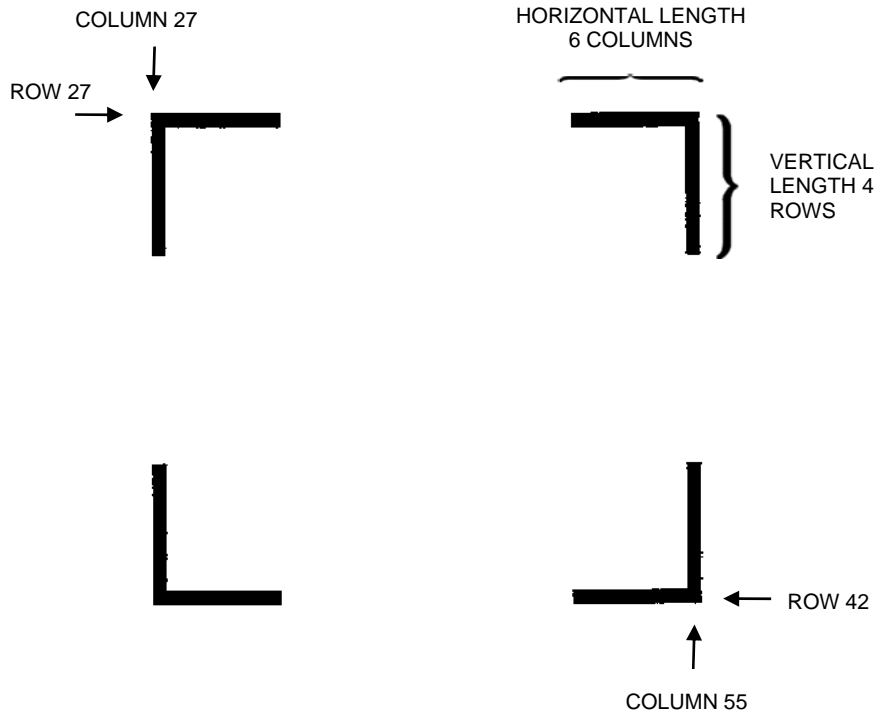

Figure 6 Corner Example

CREATE

Purpose	Places the IGP/PGL in the Create Form mode, where forms and form elements can be defined using the appropriate commands.
Mode	NORMAL
Format	(cc)CREATE; [/]formname [;FL] [;NOMOTION] [;DISK]
(cc)	The Special Function Control Code.
CREATE	The Create Form mode command; enter CREATE.
/	The optional debug character to check the program line by line for incorrect parameters and print boundaries using the current page size; enter the slash symbol (/) to debug the program. No checks are made until the completed program is sent to the IGP/PGL for storage (when the form is executed by printing the file with the IGP/PGL program). Then the form name is entered into the directory, and the program is evaluated. If errors are detected, the program will print, line by line (including the error on the line where the error occurs), followed by the error-free sections of the form. Correct all errors and delete the slash. Refer to Solving Program Errors on page 289.
formname	Defines the form name of the form being created. The form name should be no more than 15 characters in length. Refer to page 22 for a list of allowable form name characters. If a form is created with the same name as a form already existing in memory, the newly created form will replace the existing form. All future reference to the form (editing, executing, or deleting the form from the directory) must be made using the assigned name.
FL	The optional forms length parameter to specify the length of the form in IGP dot rows. (Form length cannot exceed the physical length of the page. Refer to Appendix 0). Specify the form length in one of four ways: <ol style="list-style-type: none">Enter 0 to define a form of unspecified length. The form ends after the longest element specified in CREATE mode.Enter a value for the form length ranging from 1 through 65535 to specify the forms length in IGP dot rows.Do not specify this parameter. A default of 792 IGP dots (11 inches) is then selected.Enter X to define the form length of undetermined length Upon EXECUTE mode, the form's length is determined by the physical page length setting (which depends on the paper orientation).
DISK	Optional parameter to store the form to the Onboard Flash Memory. Enter DISK . For XML driven forms, use the DISK option. See Link on page 74 for a description and example on XML forms. Enter EMC to store the form to the SD card or External Memory Cartridge. See Flash Memory Storage on page 18.

Example

The following command creates a form named ORDER with the default forms length:

```
(cc)CREATE;ORDER
```

Dark Printing

A DARK parameter, available in the Alpha, Reverse, and Bar Code commands, is like the double-strike feature in impact printers which produces bolder, darker text, denser black backgrounds for reverse print, and extra- dark, more readable bar codes.

For barcodes, the Dark parameter fills in the space between two adjacent dots in the horizontal direction. The DARK parameter will take affect if there is more than one dot in the horizontal direction. The DARK parameter will not take affect if there is only one dot on the horizontal direction.

For example, the Intelligent Mail 4-State barcode contains a bar only one dot wide. In the horizontal rotation (0 or 180 degrees), the DARK option will not take affect since there is only one dot for each bar in the horizontal direction. However, in the vertical rotation (90 or 270 degrees), the DARK option will take effect since there is more than one dot for each bar in the horizontal direction. For barcodes such as EAN, whose bar is more than one dot wide, the DARK option will take effect in both vertical and horizontal rotations since in both rotations, there is more than one dot for each bar in the horizontal direction.

Define Month Names

Purpose	Allows the creation of user-definable strings to be used as full and abbreviated month strings in the clock elements. This allows users to create these names in any language.
Mode	NORMAL
Format	(cc) MONTH;F or A; Name01 Name02 .. Name12 END MONTH The define Month Names command. F Define Full Month Names (Translations for clock element "M") A Define Abbreviated Month Names (Translations for clock element "A") END Ends the command.

Comments

Every Month Name to be defined must be entered on it's own line, terminated by a line terminator.

Empty Names will be set to their full default value. Defaults for "F" are the English month names (January–December). For the "A" parameter, the defaults are the 3–letter abbreviated English month names (Jan–Dec).

The command may be ended without defining all 12 names, the non–defined names will not change.

Example

See Clock Element Format on page 43.

Delete Font

Purpose	Deletes the font identified by the font name which resides in flash memory or RAMDISK memory.
Mode	NORMAL

Format (cc) DELETE FONT;fontname:[DISK]
(cc) The Special Function Control.
DELETE FONT The Delete Font Command; enter DELETE FONT.
fontname Identifies the font to be deleted. Enter the name of the font exactly as it was created.
DISK Optional parameter. Enter **DISK** to delete the font from Onboard Flash Memory. Enter **EMC** to delete the font from the SD card or External Memory Cartridge. When DISK is not specified, the font is deleted from RAMDISK. See Flash Memory Storage on page 18.

Comment

When loading fonts to RAMDISK, the printer files will not be saved to RAMDISK when the printer is powered off. When loading fonts to flash memory, the printer files will be saved when the printer is powered off. Both RAMDISK and flash memory support file operations such as saving, reading, and deleting files. Removing all font files with *ALL as fontname is not currently supported.

Example

The following example deletes a downloaded true type font named times.ttf from flash memory.

~DELETE FONT;times.ttf;DISK

NOTE: The space of files deleted from flash are not reclaimed for general use within the flash file system until an Optimize&Reboot operation is performed. It is not recommended to frequently store or delete files to flash. If the Optimize&Reboot operation is not available in the menu system, then deleted files are reclaimed by the printer for general use.

Delete Form

Purpose Deletes the form identified by the form name from memory.
Mode NORMAL
Format (cc)DELETE FORM;formname [;DISK]
DELETE FORM
The Delete Form command.
formname Identifies the form to be deleted. You can delete all forms by entering *ALL as the form name.
DISK If applicable, the form deletes from both RAM and FLASH. Enter **DISK** to delete the form from Onboard Flash Memory. Enter **EMC** to delete the form from the SD card or External Memory Cartridge. See Flash Memory Storage on page 18.

NOTE: The space of files deleted from flash are not reclaimed for general use within the flash file system until an Optimize&Reboot operation is performed. It is not recommended to frequently store or delete files to flash. If the Optimize&Reboot operation is not available in the menu system, the deleted files are reclaimed by the printer for general use.

Delete Logo

Purpose Deletes the logo identified by the logo name from memory.
Mode NORMAL
Format (cc)DELETE LOGO;logoname [;DISK]

DELETE LOGO

The Delete Form command.

logoname Identifies the logo to be deleted. You can delete all logos by entering *ALL as the logo name.

DISK If applicable, the logo deletes from both RAM and FLASH. Enter **DISK** to delete the logo from Onboard Flash Memory. Enter **EMC** to delete the logo from the SD card or External Memory Cartridge. See Flash Memory Storage on page 18.

NOTE: The space of files deleted from flash are not reclaimed for general use within the flash file system until an Optimize&Reboot operation is performed. It is not recommended to frequently store or delete files to flash. If the Optimize&Reboot operation is not available in the menu system, then deleted files are reclaimed by the printer for general use.

Directory

Purpose Prints the following information: (1) all defined forms and logos, (2) logo assignment to forms, and (3) memory usage and availability for DRAM, Onboard Flash Memory, and SD/EMC (if available).

Mode NORMAL

Format (cc)DIRECTORY[;DISK or ;EMC]

(cc) The Special Function Control Code.

DIRECTORY The Directory command; enter **DIRECTORY**.

DISK or EMC Optional parameter to specify the forms and logos stored in permanent memory. Enter **DISK** for Onboard Flash Memory or enter **EMC** to include the SD card or Extended Memory Cartridge.

Comments

As many forms and logos as printer memory allows may be stored in IGP/PGL memory. If the memory is full, the form will not print; available space in the memory must be at least the size of the form being executed.

For more information, refer to the Directory Example on page 288.

Duplication, Horizontal

Purpose Defines both the number of times form elements are duplicated horizontally and the spacing between each duplication.

Mode CREATE

Format HDUP;*dup#*;*offset#*
elements to be duplicated

HDUP;OFF

HDUP The Horizontal Duplication command; enter **HDUP**.

dup# Specifies the duplication number, which is the number of times the entered form element(s) will repeat horizontally. Enter a value ranging from 1 through 255.

offset## Specifies the horizontal offset to establish the horizontal spacing between each duplication of the form element(s) specified in the body of the command. Enter a value in terms of dot or character columns based on the Scale command (page 95), or use the CP.DP format (page 24). The offset is from starting column to starting column.

HDUP;OFF Terminates the Horizontal Duplication command; enter **HDUP;OFF**. If not entered, the IGP/PGL expects another form element to be defined for duplication. A single HDUP command can define different types of elements for duplication.

Example

The following example is a horizontal duplication of a series of vertical lines. To illustrate positioning, starting row and column are indicated on the example but do not necessarily reflect actual location on the page.

```

HDUP;14;4           (14 dupes with 4-character column spacing)
VERT               (Command to duplicate horizontally)
1;10;59;59.6      (Note CP.DP format: 59.6)
1;10.3;58.9;59.9
1;11;58.6;60
1;11.3;58.3;60.3
1;12;58;60.6
1;12.3;58.3;60.3
1;13;58.6;60
1;13.3;58.9;59.9
STOP              (Stops the command to duplicate element)
HDUP;OFF          (Terminates the horizontal duplication)

```

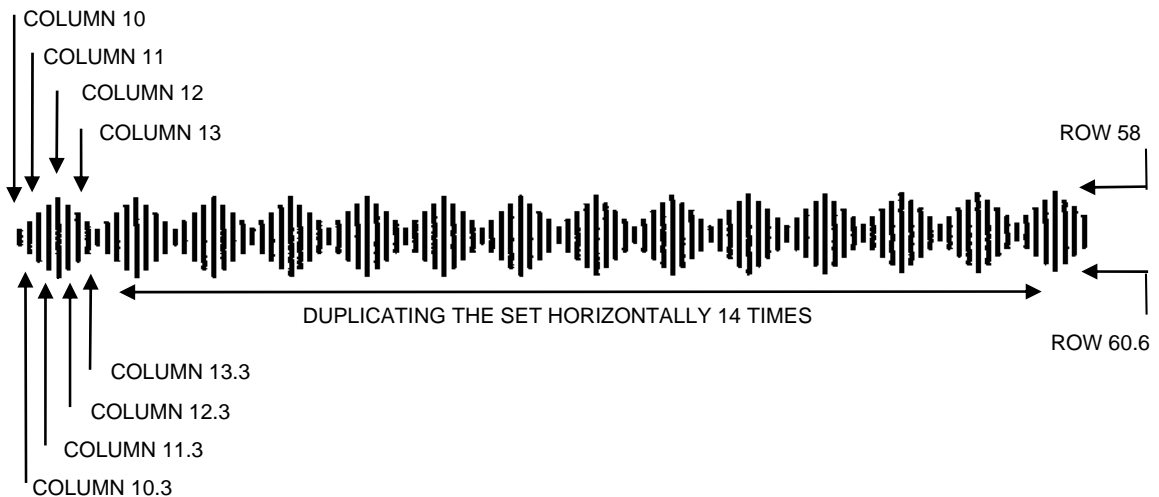

Duplication, Vertical

Purpose Defines both the number of times elements are duplicated vertically and the spacing between each duplication.

Mode	CREATE
Format	VDUP; <i>dup#</i> ; <i>offset#</i> <i>elements to be duplicated</i>
	VDUP;OFF
VDUP	The Vertical Duplication command; enter VDUP .
<i>dup#</i>	Specifies the duplication number, which is the number of times the entered form element(s) will repeat vertically. Enter a value ranging from 1 through 255 .
<i>offset#</i>	Specifies the vertical offset to establish the vertical spacing between each duplication of the form element(s) specified in the body of the command. Enter a value in terms of dot or character columns based on the Scale command (page 95), or use the CP.DP format (page 24). The offset is from starting row to starting row.
VDUP;OFF	Terminates the Vertical Duplication command; enter VDUP;OFF . If not entered, the IGP/PGL expects another form element to be defined for duplication. A single VDUP command can define different types of elements for duplication.

Example

The following example is a vertical duplication of one horizontal line. The line is duplicated three times. To illustrate positioning, the starting row and column are indicated on the example but do not necessarily reflect actual location on the page.

```

VDUP;3;2          (3 duplications with 2-char. row spacing)
HORZ             (Command to duplicate vertically)
1;52;15;65
STOP            (Stops the command to duplicate element)
VDUP;OFF       (Terminates the vertical duplication)

```

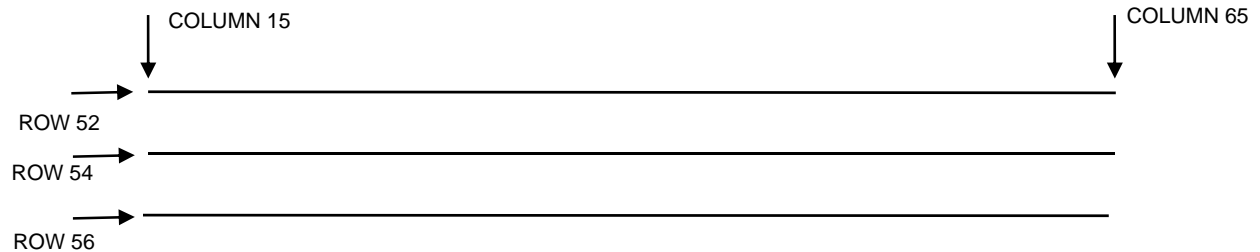

Emulation Switching

Purpose	To switch the active emulation from IGP/PGL to the emulation selected.	
Mode	NORMAL	
Format	(cc)EMULATION; <i>emulation</i>	
	(cc)	The Special Function Control Code.
	EMULATION	The Emulation Switch command.
	<i>emulation</i>	Specifies the emulation to activate. Enter V to switch to VGL and P to switch to ZGL.

Comments

The switching of emulations causes IGP/PGL to perform a soft reset. Therefore, front panel selections return to their saved state, and all forms and logos resident in RAM memory are deleted. Enter V to select VGL and P for ZGL.

End

Purpose	Terminates the current mode of operation and must be used before entering a new mode command (EXECUTE, LOGO, NORMAL, or even CREATE).	
Mode	CREATE	
Format	END	

Comments

After the End command is received, the IGP/PGL flushes program errors, stores the error-free portions of the form program just completed, and then returns to the Normal mode. If the debug slash (/) is included in the Create command, the program prints with any corresponding error messages.

Enquiry

Purpose	To send information (a status byte) about the printer state to the host through the serial port. This command is ignored if the current host interface is not the serial port. This is an online command and is not required to be followed by a terminator.	
Mode	NORMAL, CREATE, or EXECUTE	
Format	(cc) ENQUIRY	
	ENQUIRY	The Enquiry command. Enter ENQUIRY.

Execute Form Mode

How to Use the Execute Command

Forms are printed in the Execute Form mode. In addition to printing the form in the Execute Form mode, variable data can also be entered onto the form “dynamically” during the Execute Form mode. This dynamic data input during the Execute Form mode includes page numbers, alphanumeric data fields, and bar code data fields. Pagination, described on page 81, is performed in the Execute Form mode. Dynamic alphanumeric and bar code data require additional commands within the Execute Form mode.

The fastest method for repeated forms printing is to use the form feed character. Rather than sending a series of Execute/Normal commands, which slows the process by performing an *open-print-close* form sequence, the form feed character instructs the IGP/PGL to start a new page with new EVFU, dynamic

and overlay data using the existing Execute commands for the form. The *EVFU Data-Dynamic Data-Overlay Data-Form Feed Character* sequence can be repeated indefinitely while maintaining the optimum print speed within the original Execute command.

Remember, when a form count is not specified, a single line spacing (or a line containing overlay data) must always separate an EXECUTE command from a NORMAL command.

To Execute Forms Rapidly

In order to save reloading time, the IGP/PGL remembers the last form executed. However, a form must be loaded if it was not the last form executed, if it was used with a CREATE command since the last EXECUTE, or if any logo has been created.

When the form to be executed is found in memory, it is loaded and execution resumes; otherwise, the "FORM NOT FOUND" error is printed.

Print Formats in the Execute Form Mode

The Execute Form mode has two print formats. The *standard* execute command format, shown on page 58, is used for executing non-incremental data and incremental fixed data. An *incremental* Execute command format, containing two additional parameters, is used for executing incremental dynamic data and is discussed on page 63.

During the Execute Form mode, the IGP/PGL responds to regular print format commands such as 8 lpi, and elongated characters. Some commands can be used in other modes in addition to the Execute Form mode. For example, Compressed Print, Expanded Print, Execute, Ignore, Select Format, and Vertical Line Spacing, which are also Normal mode commands, can be used in the Execute or Create Form modes. The IGP/PGL alternate character set can also be used in the Execute Form mode.

Execute Form: General Format

Purpose	Prints forms created in the CREATE mode.
Mode	NORMAL
Format	(cc)EXECUTE ; <i>formname</i> [;SAVEDYN] [;PAGE <i>n</i>] [;FC] [;ICNT <i>n</i>] [;FCNT <i>n</i>] [;IRST <i>n</i>] [;DISK] [;DISK] [<i>EVFU Data</i>] [(cc)AF <i>n</i> ; (D)ASCII text(D)] [(cc)BF <i>n</i> ; (D)data(D)] [(cc)DF <i>n</i> ; (D)data(D)] [(cc)AF <i>n</i> ; <DF <i>n</i> >] [(cc)BF <i>n</i> ; <DF <i>n</i> >] [(cc)GF <i>n</i> ; (D)logoname(D)] [(cc)IAF <i>n</i> ; [<i>idir</i>] STEPMASK;[RPT <i>n</i> ;] [RST <i>n</i> ;] (D)STARTDATA(D)] [(cc)IBF <i>n</i> ; [<i>idir</i>] STEPMASK;[RPT <i>n</i> ;] [RST <i>n</i> ;] (D)STARTDATA(D)] [(cc>IDF <i>n</i> ; [<i>idir</i>] STEP;[RPT <i>n</i> ;][RST <i>n</i> ;] (D)STARTDATA(D)] [<i>Overlay Data</i>] [<i>Form Feed character</i>] (cc)NORMAL
(cc)	The Special Function Control Code.
EXECUTE	The Execute Form command; enter EXECUTE.
<i>formname</i>	Identifies a previously defined form by name. Enter the form name exactly as used when created.
SAVEDYN	The optional command to have dynamic fields saved across forms that are separated with a form feed character.

PAGE <i>n</i>	The optional Pagination command; enter PAGE , a space, and replace <i>n</i> with the decimal number of the starting page in a sequence of multiple pages. The number may be eight digits long and range between 0 and 99999999 . The next page after 99999999 is 0. Be sure to leave a blank space between the PAGE command and the <i>n</i> value. The page number will print on the form in the location defined by the Page Number command in the Create Form mode. If the location of the pagination field was not specified in the Create Form mode, the page field is printed in the upper left corner of the form.
FC	The optional form count parameter specifies the number of copies of the form to print. Enter the appropriate number. When the last page prints, the IGP/PGL returns to the Normal mode automatically. Do not use the form count parameter if dynamic data (<i>AFn</i> and <i>BFn</i> parameters), incremental data (FCNT, ICNT, or IRST parameters), overlay data, or EVFU data are used in the Execute command.
FCNT <i>n</i>	The optional incremental form count. Enter FCNT (functions the same as ICNT and the form count value). However, with FCNT, both incremental dynamic data (IAF or IBF) and non-incremental dynamic data (AF or BF) will be printed on each page. With ICNT, only incremental dynamic data will be printed on each page and non-incremental dynamic data will only be printed on the first page.
ICNT <i>n</i>	The optional incremental form count. Enter ICNT and the Incremental value as described in the Execute Incremental Dynamic Data command described on page 63.
IRST <i>n</i>	The optional incremental reset count parameter. Enter IRST and the reset value as described in the Execute Incremental Dynamic Data command described on page 63.
DISK	Optional parameter that specifies to recall the form from Onboard Flash Memory. Enter DISK . To recall the form from the SD Card or Expanded Memory Cartridge, enter EMC . This option is not required since the printer automatically searches DRAM, the Expanded Memory Cartridge, and Flash. See Flash Memory Storage on page 18.
<i>EVFU Data</i>	Optional parameter to use the EVFU to overlay data onto the form. (“EVFU Data” is not part of the Execute command. It is shown in the command sequence to indicate that actual EVFU data can be entered following the Execute command.) Enter EVFU data as described in Appendix D and on page 61.
(cc) <i>AFn;(D)ASCII text(D)</i>	The Execute Dynamic Alphanumeric Data command. Enter the dynamic alphanumeric data during the Execute Form mode as described in Execute Form: Dynamic Alphanumeric Data on page 61.
(cc) <i>BFn;(D)data(D)</i>	The Execute Dynamic Bar Code Data command. Enter the dynamic bar code data during the Execute Form mode as described in Execute Form: Dynamic Bar Code Data on page 62.
(cc) <i>GFn;(D)logoname(D)</i>	The Execute Dynamic Logo Command. Enter the name of the logo during the Execute Form mode as described in Execute Form: Dynamic Logo on page 63.

(cc)IAFn; [idir] STEPMASK; [RPTn;] [RSTn;] (D)STARTDATA(D)

The Execute Incremental Dynamic Alphanumeric Data command. Supply the data as described on page 64.

(cc)IBFn; [idir] STEPMASK; [RPTn;] [RSTn;] (D)STARTDATA(D)

The Execute Incremental Dynamic Bar Code Data command. Supply the data as described on page 64.

Overlay Data Overlay data can be entered during the Execute Form mode. (The words "Overlay Data" are not part of the Execute command. They are shown in the command sequence to indicate that actual overlay data can be entered following the Execute command.) Refer to Execute Form: Overlay Data on page 65.

Form Feed Character

Optional command instructing the IGP/PGL to start a new page with new EVFU, dynamic, and overlay data using the existing Execute commands for the current form. This *EVFU Data-Dynamic Data and Overlay Data-Form Feed Character* sequence can be repeated indefinitely, while maintaining the optimum print speed, within the original Execute command.

(cc)NORMAL The Normal mode command. If the form count parameter was not used in the Execute command, enter the SFCC and **NORMAL** to return the IGP/PGL to the Normal mode. The Normal mode command is input following all other Execute commands to enter variable data. (Refer to the following sections.) Input a line terminator to leave a blank line before entering the Normal command.

Execute Form: Electronic Vertical Format Unit

Purpose	Provides an efficient method of automatically skipping to a specified print line during repetitive printing tasks.
Mode	EXECUTE
Format	See Appendix D.

Comments

The Electronic Vertical Format Unit (EVFU) is used as overlay data within the Execute Form mode. Detailed EVFU information is provided in Appendix D.

The EVFU must be loaded while in the Execute Form mode and immediately following the Execute command. After executing the form and returning to Normal mode, the EVFU information is automatically deleted from printer memory. To print the form again, re-send the EVFU command.

Several key points to operating the EVFU are listed below.

- Send EVFU commands immediately following the Execute command or the format form feeds.
- The EVFU can be unloaded by issuing an END LOAD command only.
- The number of lines slewed is dictated by the current line spacing (lpi) setting.
- In those circumstances where the EVFU is being used to control the forms length only, the IGP/PGL forms length parameter can be used in place of the EVFU.
- The maximum number of EVFU channels is 192.
- Changing the LPI unloads the EVFU.

Execute Form: Dynamic Alphanumeric Data

Purpose	Incorporates the dynamic alphanumeric data into a previously identified location of a form.								
Mode	EXECUTE								
Format	$(cc)AFn;(D)ASCII\ text(D)$ <table><tr><td>(cc)</td><td>The Special Function Control Code.</td></tr><tr><td>AFn</td><td>Indicates a dynamic alphanumeric field (AF) and its data (n). Enter AF and replace n with the number of the data field corresponding to the number used to identify the field when it was defined with the Alphanumeric command in the Create Form mode.</td></tr><tr><td>(D)</td><td>The printable character identifying the start and finish of the alphanumeric data. Enter any printable character other than a slash (/), the SFCC, or a character used within the data. The same character must be used at both ends of the data field but will not be printed with the data.</td></tr><tr><td>$ASCII\ text$</td><td>The group of ASCII characters (the alphanumeric string) to print. Enter any of the standard ASCII printable characters (except the character used as delimiters described in the (D) parameter). The data appears on the form at the location identified by n.</td></tr></table>	(cc)	The Special Function Control Code.	AFn	Indicates a dynamic alphanumeric field (AF) and its data (n). Enter AF and replace n with the number of the data field corresponding to the number used to identify the field when it was defined with the Alphanumeric command in the Create Form mode.	(D)	The printable character identifying the start and finish of the alphanumeric data. Enter any printable character other than a slash (/), the SFCC, or a character used within the data. The same character must be used at both ends of the data field but will not be printed with the data.	$ASCII\ text$	The group of ASCII characters (the alphanumeric string) to print. Enter any of the standard ASCII printable characters (except the character used as delimiters described in the (D) parameter). The data appears on the form at the location identified by n .
(cc)	The Special Function Control Code.								
AFn	Indicates a dynamic alphanumeric field (AF) and its data (n). Enter AF and replace n with the number of the data field corresponding to the number used to identify the field when it was defined with the Alphanumeric command in the Create Form mode.								
(D)	The printable character identifying the start and finish of the alphanumeric data. Enter any printable character other than a slash (/), the SFCC, or a character used within the data. The same character must be used at both ends of the data field but will not be printed with the data.								
$ASCII\ text$	The group of ASCII characters (the alphanumeric string) to print. Enter any of the standard ASCII printable characters (except the character used as delimiters described in the (D) parameter). The data appears on the form at the location identified by n .								

NOTE: Commands can appear anywhere in the overlay text with IGP/PGL, but it is recommended they are placed at the beginning.

Comments

The location for the Dynamic alphanumeric data must have been previously identified using the *AFn;L* parameters of the alphanumerics command in the Create Form mode. Inputting individual commands enters the new data into the identified location each time the form is printed.

You can repeat the *(cc)AFn;(D)ASCII text(D)* sequence to complete as many data fields as you defined on the form in the Create Form mode. You can also combine the Execute Dynamic Bar Code Data command in the same Execute command sequence. Each “page” of dynamic data (the dynamic fields, data, and overlay data) for the form must be separated from the next page of new dynamic data by a form feed.

Execute Form: Dynamic Bar Code Data

Purpose	Incorporates the dynamic bar code data into a previously identified location of a form.
Mode	EXECUTE
Format	<i>(cc)BFn;(D)data field(D)</i>
	<i>(cc)</i> The Special Function Control Code.
	<i>BFn</i> Indicates a dynamic bar code field (BF) and its data (<i>n</i>). Enter BF and replace <i>n</i> with the number of the data field corresponding to the number used to identify the field when it was defined with the bar code command during the Create Form mode.
	<i>(D)</i> The printable character (quotation marks for example) identifying the start and finish of the bar code data. Enter any printable character other than a slash (/), the SFCC, or a character used within the data. The same character must be used at both ends of the data field but will not be printed with the data.
	<i>data field</i> Enter the characters for the bar code data. The type of characters allowed in the data varies with the type of bar code. Refer to the data field descriptions for the selected bar code types. The data appears on the form at the location identified by <i>n</i> .

NOTE: Commands can appear anywhere in the overlay text with IGP/PGL, but it is recommended they are placed at the beginning.

Comments

The bar code location must have been previously identified using the *BFn;L* parameters of a bar code command in the Create Form mode. Then use the appropriate bar code command to enter the bar code data in that location. Inputting individual commands enters new bar code data into the identified location each time the form is printed.

You can repeat the *(cc)BFn;(D)data field(D)* sequence to complete as many bar code data fields as were defined on the form in the Create Form mode. You can also combine the Execute Dynamic Alphanumeric Data command in the same Execute command sequence. Each “page” of dynamic data (the dynamic fields, data, and overlay data) for the form must be separated from the next page of new dynamic data by a form feed.

Execute Form: Dynamic Logo

Purpose	Incorporates the dynamic graphic logo into a previously identified location of a form.
Mode	EXECUTE
Format	<i>(cc)GF<i>n</i>;(D)logoname(D)</i>
<i>(cc)</i>	The Special Function Control Code.
<i>GF<i>n</i></i>	Indicates the dynamic logo field. Enter GF and replace <i>n</i> with the number of the field corresponding to when it was defined with the Logo Call command during the CREATE form mode.
<i>(D)</i>	The printable character identifying the start and finish of the alphanumeric data. Enter any printable character other than a slash (/), the SFCC, or a character used within the data. The same character must be used at both ends of the data field but will not be included in the logo name.
<i>logoname</i>	Enter the logo name. If the logo is not found in DRAM, the flash memory is searched.

Comments

The logo location must have been previously identified using the *GF*n** parameters of a logo command in the Create Form mode. Then use the appropriate logo command to enter the logo data in that location. Inputting individual commands enters new logo data into the identified location each time the form is printed.

You can repeat the *(cc)GF*n*;(D)logoname(D)* sequence to complete as many logo data fields as were defined on the form in the Create Form mode. You can also combine the Execute Dynamic Alphanumeric Data command in the same Execute command sequence. Each “page” of dynamic data (the dynamic fields, data, and overlay data) for the form must be separated from the next page of new dynamic data by a form feed.

NOTE: There are no incremental logos.

Execute Form: Incremental Dynamic Data

Purpose Incorporates incremental/decremental capability to dynamic alphanumeric or bar code data supplied as a part of the Execute Form mode.

Mode NORMAL

NOTE: In the command below, incremental Execute parameters are shown in **boldface type**; standard Execute command parameters are shown in *italics*. The general Execute format is shown on page 58.

Format	<i>(cc)EXECUTE; formname [;<i>PAGE</i><i>n</i>] [;<i>FC</i>] [ICNT<i>n</i>] [IRST<i>n</i>]</i>
<i>ICNT</i> <i>n</i>	Identifies the incremental form count to specify the number of forms to generate with the incremental fields automatically updated. Enter ICNT and replace <i>n</i> with a value ranging from 1 through 65535 to specify the number of forms.
<i>IRST</i> <i>n</i>	The optional incremental reset count parameter to specify the number of forms to generate before resetting all incremental fields to their starting values. The reset count parameter is useful in dividing the total number of forms generated into multiple groups of identical copies. To use this parameter, enter IRST and replace <i>n</i> with a value ranging from 1 through 65535 to specify the reset count (how many forms generated before

resetting the incremental fields). If the reset count value is equal to or greater than the incremental count value, the reset will never occur.

Example

The following forms were generated from ICNT6, IRST2. (To duplicate incremental fields within a form, refer to page 36.)

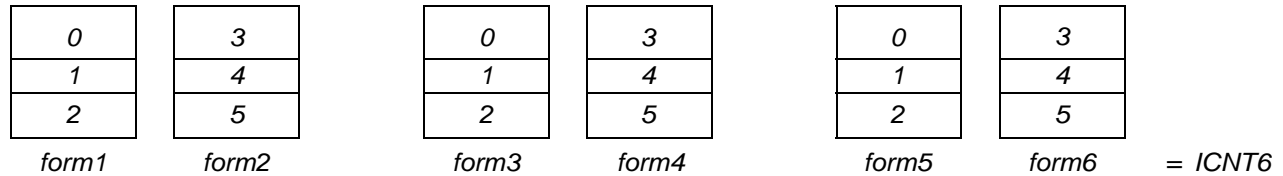

Supplying Dynamic Data for Incremental Fields

Incremental dynamic data fields are created in the Create Form mode using the incremental alphanumeric or bar code commands. The incremental dynamic data itself is supplied during the Execute Form mode at the top of the form prior to any overlay data. The incremental dynamic data (either alphanumeric or bar code data) can be changed with each new batch of forms. Incremental dynamic data fields specified in the Create Form mode will not appear on the form if corresponding incremental dynamic data is not supplied in the Execute Form mode.

Format

For incremental dynamic alphanumeric data:

(cc)IAF*n*; [*idir*] STEPMASK; [RPT*n*;] [RST*n*;] (D)STARTDATA(D)

For incremental dynamic bar code data:

(cc)IBF*n*; [*idir*] STEPMASK; [RPT*n*;] [RST*n*;] (D)STARTDATA(D)

(cc) The Special Function Control Code.

IAF Identifies the command as an incremental alphanumeric dynamic data; enter **IAF**.

IBF Identifies the command as an incremental bar code dynamic data; enter **IBF**.

n Identifies the field number of the dynamic data field as entered in the Create Form mode. Replace *n* with the number used to identify the field when it was defined.

idir The optional increment direction parameter to specify an increase or decrease of the data. Enter a plus sign (+) or leave the field blank to increment (the default). Enter a minus sign (-) to decrement.

STPEMASK Defines the increment amount (step), the number of character positions in the data field, and provides a mask to control the increment function on specific parts of the data. Refer to Incremental Bar Code Fields on page 253 or Alphanumerics, Incremental Fields on page 30 for complete information on STEPMASK parameter values.

RPT*n* The optional incremental repeat count parameter to specify the number of times a particular field value is repeated before it is incremented. A repeated field value is useful when printing multiple rows/columns of identical labels before incrementing to the next value. To use the repeat count parameter, enter **RPT** and replace *n* with a numeric value ranging from 1 through 65535 to specify the repeat count. The default repeat count parameter is 1, which will increment the field value each time it is printed.

RST <i>n</i>	The optional incremental reset count parameter to specify the number of times an incremented field is printed (on one or more forms) before it is reset to the starting value. A reset count is useful when printing a hierarchy of fields where a low-level field generates a sequence of numbers, is reset, and the next higher field level is incremented (such as in a unit/box/carton application). To use the reset count parameter, enter RST and replace <i>n</i> with a number ranging from 1 through 65535 to specify the reset count. The default reset count value is 0.
STARTDATA	Defines the starting value of the incrementing field. The maximum amount of STARTDATA characters must be equal to or less than the number of characters in the STEPMASK field. If the number of data characters in dynamic alphanumeric data commands only is less than the number used in STEPMASK , the data will print right justified with preceding spaces. (Leading spaces are not provided for bar code data.) For dynamic bar code data, the type of characters allowed for incrementing fields is based on the type of bar code. Refer to the individual bar code descriptions in the Bar Codes chapter for information on valid type and quantity of data characters. The STARTDATA must be enclosed within standard printable character delimiters just as a standard data field is enclosed within delimiters.

Execute Form: Overlay Data

Overlay data is variable alphanumeric data entered onto a predefined form. The form is completed by positioning the data in the exact location it will appear on the form when printed. The data is placed horizontally using tabs and spaces, and vertically using line feeds, form feeds, and the EVFU.

For example, if the serial number field on the form begins at character row 22, and column 14, enter 22 line feeds, space over 14 columns, and input serial number overlay data. An entire form can be completed with a page of overlay data in this manner. Overlay data at the end of a form is printed on a new form until all overlay data is used. Then, to advance to the next form, use a form feed.

The IGP/PGL Electronic Vertical Format Unit can be used to control vertical spacing of the overlay data. In place of line feed commands input individually, the EVFU can be programmed (during the Execute Form mode) to slew the overlay data page to the predetermined lines with a single command.

NOTE: When using the IGP/PGL, the Dynamic Data command and Overlay IGP/PGL commands may be issued on the same line as the overlay text to synchronize the printer with systems that count lines (e.g., I.B.M.). See the IGP/PGL command standard for inline command format on page 21.

Expanded Print

Purpose	Selects font sizes other than the default font.
Mode	NORMAL, EXECUTE
Format	(cc)EXPAND; <i>VE</i> ; <i>HE</i>
(cc)	The Special Function Control Code.
EXPAND	The Expanded Print command; enter EXPAND .
<i>VE</i>	Specifies the vertical expansion factor; enter a value ranging from 0 through 139 . Use vertical expansion with 12 point font size only.
<i>HE</i>	Specifies the horizontal expansion factor; enter a value ranging from 0 through 139 . Use horizontal expansion with 12 point font size only.

NOTE: Both *VE* and *HE* parameters must be zero or non-zero. One expansion value cannot be specified as 0 if the other is not. A *VE* or *HE* setting of 1 expands the appropriate plane but produces single-size characters. A *VE* and *HE* setting of 0 produces standard-size characters.

Comments

The Expanded Print command uses the 0.10-inch, 10 cpi Gothic typeface as the default base value from which alphanumeric characters are expanded. (Refer to the Font command on page 66 for more information about available typefaces and styles.)

The character height can be up to a maximum of 13.9 inches, which means if a page is 13.9 inches high, you can print a character that fills the entire height of the page.

After an Expanded Print command is entered, all subsequent alphanumerics print at the specified expansion until another Expanded Print command, a Normal mode command, or a Reset command is entered. An Expanded Print command with *VE* and *HE* set to 0 selects standard character printing.

Example

The following command results in character printing at 25 times its vertical and 40 times its horizontal size.

```
~EXPAND;25;40
```

Font

Purpose Selects typefaces other than the default Gothic font.

Mode NORMAL, CREATE, EXECUTE

Format (cc)FONT [;FACE #] [NAME #] [;BOLD #] [;BLOCK #] [;SLANT #] [;SYMSET #] [;POINT #] [;SPACE #] [;ZERO #] [WIDTH#]

NOTE: The font is activated according to the changed options upon receipt of the font command.

(cc) The Special Function Control Code. (If you are using the Font command in the CREATE mode, *do not* enter the SFCC.)

FONT The Font command; enter **FONT**.

FACE # Identifies the specific typeface. Enter **FACE**, a space, and the 5 digit typeface number representing the selected typeface.

93952 = Courier New Bold

93779 = Letter Gothic Bold

Other font numbers correspond to optional typefaces. Refer to the font instructions for typeface numbers.

Do not use this command to select OCR-A and OCR-B. Instead, use either the *Cn* parameter in the Alphanumerics command or use the Compressed Print Density command.

NOTE: FACE # 1, 2 and 3 are for importing HP Soft Fonts. Please contact your distributor for further information.

NAME # Selects a font by its file name. Enter **NAME**, a space, and the file name of the font, including its extension. The maximum length of the name is 8 characters and the maximum length of the extension is 3 characters.

For example, "93952.sf" specifies Courier New Bold (Intellifont), and "arial.ttf" would represent Arial (TrueType).

If this parameter is used, then the FACE parameter should not be used.

BOLD #	Selects a bold attribute. Enter BOLD , a space, and ON or 1 to turn bold on, or OFF or 0 for no bold attribute.
BLOCK #	Is used to select block fonts. A value of zero turns the block fonts off and uses scalable fonts (the default). A value of 1 uses the block font set, and a value of 2 uses the first alternate block font set.
SLANT #	Selects a slanting factor. (Slant is similar to italic, but also offers a backward slant.) Enter SLANT , a space, and RIGHT or 1 for a typical italic slant, LEFT or -1 for a backward slant, or OFF or 0 for no slant attribute.
SYMSET #	Selects a font symbol set other than the default ASCII symbol set. Enter SYMSET , a space, and ' UTF8 ' to select the UTF8 character set or enter a number following the space to select the corresponding symbol set.
POINT #	Selects the point size for the current typeface. Enter POINT , a space, and a point size ranging from 4 through 999 . Point sizes are available in quarter-point increments. Horizontal pitch is automatically adjusted based on the point size selected. The POINT parameter cannot be used when in CREATE mode. Use the point parameter of the ALPHA command for the text in CREATE mode.
SPACE #	Selects a spacing alignment scheme, where applicable. Enter SPACE , a space, followed by a value 0 through 3 .
ZERO #	It is used to select the slash zero option. A value of 0 turns off the slash zero, and a non-zero value turns on the slash zero. All ALPHA commands and text printer are affected.
WIDTH #	Selects the character width for the current typeface. Enter WIDTH, space, and a width size (from 4 to 999). Width sizes are available in quarter point increments. The WIDTH parameter cannot be used when in CREATE mode. Use the point parameter of the ALPHA command for the text in CREATE mode.

NOTE: The standard fonts available depends on the printer:

Line Matrix

Letter Gothic Bold (#93779).

Comments

Font parameters in Normal and Execute modes do not affect the fonts that have already been established and saved on a form.

Font commands issued in the Create mode affect only the current form being created and not any of the fonts on other forms or for Execute or Normal mode text.

You can use any or all Font parameters, listed in any order, in a single Font command. (Do not list font parameters on separate lines.) Parameters and symbol sets not specified retain the previously selected value. Parameters incorrectly specified retain the previously selected value.

All Font command parameters are reset to default values upon receiving a NORMAL, RESET, CONFIG;RESET, or new CREATE command. Multiple font commands within a single form will save the *last* font command parameters specified. Symbol sets can also be selected using the ISET or USET commands. (Refer to the Multinational And International Character Sets chapter 5.)

To change font width and height, use the Compressed Print (Density) or Expanded Print commands described on page 43 and page 65, respectively.

Example

The following command selects the Letter Gothic font (#93779) with a right slant. This font will continue to print until another Font command, a Normal mode command, or a Reset command is entered.

```
~FONT;FACE 93779;SLANT RIGHT
```

Font Load

Purpose Load binary TrueType Font (.ttf) or Intellifont (.sf) into RAMDISK or Flash memory.

Mode NORMAL

Format (cc)FONTLOAD; *name*; *size* [;DISK]
data
END

(cc) The Special Function Control Code.

FONTLOAD The Font Load command; enter **FONTLOAD**.

name Specify associated binary TrueType font or Intellifont data by name. Enter the name of the font, including its extension. The maximum length of the name is 8 characters and the maximum length of the extension is 3 characters. For example, **93952.sf** specifies Courier New Bold (Intellifont) and **arial.ttf** would represent Arial (TrueType).

size Enter the size, in bytes, of the binary TrueType font or Intellifont data.

DISK Optional parameter to store the binary data to Onboard Flash Memory. Enter **DISK** for Onboard Flash Memory. Enter **EMC** for the SD card. When DISK is not specified, the font is stored on RAMDISK. Refer to Flash Memory Storage on page 18.

data The binary TrueType font or Intellifont data to be stored in memory.

END Ends the FONTLOAD command. Enter **END**.

Comment

When loading fonts to RAMDISK, the printer files will not be saved to RAMDISK when the printer is powered off. When loading fonts to flash memory, the printer files will be saved when the printer is powered off. Both RAMDISK and flash memory support file operations such as saving, reading, and deleting files.

Example 1

Example 1 loads the Arial TrueType font (arial.ttf) to RAMDISK with 10489 bytes of binary data.

```
~FONTLOAD;arial.ttf;10489  
<font data=10489 bytes>END
```

Example 2

The following command loads the Arial TrueType font (arial.ttf) to Onboard Flash Memory, SD card, or Extended Memory Cartridge based on the front panel menu "Storage Select" with 10489 bytes of binary data.

```
~FONTLOAD;arial.ttf;10489;DISK  
<font data=10489 bytes>END
```

Example 3

The following command loads the Arial TrueType font (arial.ttf) to SD card with 10489 bytes of binary data. For printers without this external storage capability, this font will be loaded into Onboard Flash Memory.

```
~FONTLOAD;arial.ttf;10489;EMC  
<font data=10489 bytes>END
```

Form Length

Purpose	Sets the length of the form to a specific number of lines at 6 or 8 lpi.
Mode	CREATE
Format	LFORM6; <i>n</i> or LFORM8; <i>n</i>
LFORM6	The Form Length command for 6 lpi forms; enter LFORM6 .
LFORM8	The Form Length command for 8 lpi forms; enter LFORM8 .
<i>n</i>	Specifies the forms length in total number of lines allowed per form. The range depends on the paper size used and the top/bottom margin setting. Table 8 shows the appropriate form lengths for the paper size used when the top and bottom page margin settings are zero. An error message will result if the maximum line values are exceeded.

Table 8 Paper Sizes and Maximum Page Length

Paper Size	Dimensions (inches)	Maximum Lines Per Page (when top/bottom margins = 0)	
		6 lpi	8 lpi
Letter	8.5 x 11	66	88
Legal	8.5 x 14	84	112
A4	8.268 x 11.693	70	93
B5	6.929 x 9.842	59	78
AIAG Label	4 x 6	36	48
AIAG Label	6 x 5	30	40
Odette Label	8 x 5	30	40
Computer	14 x 11	66	88

NOTE: This command affects only printed text inside of IGP/PGL forms, not the printer lpi. The LFORM8 command considers a line as 9 dot rows; the LFORM6 command considers a line as 12 dot rows. The 9 and 12 dot rows per line matches the dot rows of the printer in the DP mode if set to 8 or 6 lpi, respectively.

Example

The following example establishes a forms length of 8 inches (48 lines at 6 lpi):

```
LFORM6 ; 48
```

NOTE: Additional information about page boundaries can be found in Appendix 0.

Hex Character Encoding

Purpose Enables the IGP to process the data in the hex character format, which only accepts characters 0-9 and A-F. This format is useful when the user needs to send down binary data in an ASCII format and does not want control codes such as line feed or carriage return to be part of the binary data. The command HEXOFF will disable this feature and return the IGP to normal data processing.

Mode NORMAL, CREATE, and EXECUTE

Format (cc)HEXON or (cc)HEXOFF

NOTE: A line terminator is not required in the Hex Character Encoding Sequence.

(cc)	The Special Function Control Code.
HEXON	Hex character encoding enabled; enter HEXON.
HEXOFF	Hex character encoding disabled; enter HEXOFF.

Comments

HEXON and HEXOFF can be used anywhere in the data stream.

Ignore Sequence

Purpose Enables the IGP/PGL to ignore all characters after the Ignore Sequence On (IGON) command is entered. All characters are ignored until the Ignore Sequence Off (IGOFF) command is entered.

Mode NORMAL, CREATE, or EXECUTE

Format (cc)IGON or (cc)IGOFF

NOTE: A line terminator is not required in the Ignore Sequence.

(cc)	The Special Function Control Code.
IGON	Ignore Sequence On command. Enter IGON .
IGOFF	Exits Ignore Sequence. Enter IGOFF .

Comments

IGON and IGOFF can also be used anywhere in the data stream.

NOTE: Commands in PTX_SETUP are not ignored.

Line Spacing

Purpose	Defines the lines per inch (lpi) printing format.
Mode	NORMAL, EXECUTE
Format	(cc)LPI; <i>n</i>
(cc)	The Special Function Control Code.
LPI	The Vertical Line Spacing command; enter LPI .
<i>n</i>	Selects the line spacing in lpi; enter a value from 1 through 1000 . The accuracy of the line spacing is limited to the resolution of the target printer.

Comments

Standard line spacing is 6 lpi. After a Vertical Line Spacing command is entered, all subsequent alphanumeric characters print at the specified lpi until another Vertical Line Spacing command, a Normal mode command, or a Reset command is entered.

Example

The following command selects 9 lpi printing format until another Line Spacing command, a Normal mode command, or a Reset command is entered.

```
~LPI ; 9
```

Lines, Diagonal

Purpose	Produces a diagonal line.
Mode	CREATE
Syntax	DIAG <i>LT</i> ; <i>SR</i> ; <i>SC</i> ; <i>ER</i> ; <i>EC</i> STOP
DIAG	The Diagonal command.
<i>LT</i>	Defines the border thickness, measured in vertical IGP dots (1/72 inch increments).
<i>SR</i>	Defines the starting row of the diagonal line (CP.DP format, dot rows or direct measurement in millimeters based on SCALE command).
<i>SC</i>	Defines the starting column of the diagonal line (CP.DP format, dot rows or direct measurement in millimeters based on SCALE command).
<i>ER</i>	Defines the ending row of the diagonal line (CP.DP format, dot rows or direct measurement in millimeters based on SCALE command).
<i>EC</i>	Defines the ending column of the diagonal line (CP.DP format, dot rows or direct measurement in millimeters based on SCALE command).

```
~CREATE ; XYZ ; 432
```

```
DIAG
```

```
2 ; 2 ; 2 ; 5 ; 10
```

```
STOP
```

```
END
```

```
~EXECUTE ; XYZ
```

```
~NORMAL
```

Lines, Horizontal

Purpose	Defines horizontal lines.
Mode	CREATE
Format	HORZ <i>LT;R;SC;EC</i> STOP
HORZ	The Horizontal Line command; enter HORZ .
<i>LT</i>	Defines the line thickness, measured in 1/72-inch dots. Enter a value of 1 or greater. Horizontal line thickness expands downward from the given row.
<i>R</i>	Defines the row to draw the horizontal line. Enter a value ranging from row 1 through one less than the length of the form. Character row or dot row is specified based on the Scale command (page 95), or use the CP.DP format (page 24).
<i>SC</i>	Defines the starting column of the horizontal line. Enter a value ranging from column 1 through one less than the width of the form. Character column or dot column is specified based on the Scale command (page 95), or use the CP.DP format (page 24).
<i>EC</i>	Defines the ending column of the horizontal line. Enter a value ranging from column 2 through the last column of the form. The ending column must be greater than the starting column. Character column or dot column is specified based on the Scale command (page 95), or use the CP.DP format (page 24).
STOP	Stop indicates the end of the HORZ command; enter STOP . If not entered, the IGP/PGL will expect another set of Horizontal Line command parameters.

Example

The following example specifies 2 horizontal lines. The first line uses the character row in the **R** parameter, and the second line uses CP.DP format. To illustrate positioning, the starting row and column are indicated on the example but do not necessarily reflect actual location on the page.

```
HORZ
1;60;15;65
1;60.5;15;65
STOP
```

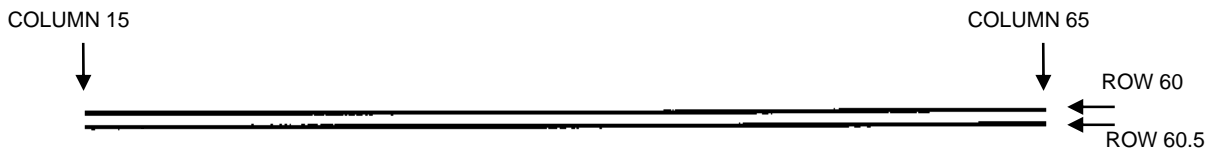

Lines, Vertical

Purpose Defines vertical lines.

Mode CREATE

Format VERT *LT*;*C*;*SR*;*ER*

STOP

VERT The Vertical Line command; enter **VERT**.

LT Defines the line thickness, measured in 1/60-inch dots. Enter a value of 1 or greater. Vertical line thickness expands to the right from the starting column.

C Defines the column where the vertical line begins. Enter a value ranging from column 1 through one less than the width of the form. Character column or dot column is specified based on the Scale command (page 95), or use the CP.DP format (page 24).

SR Defines the starting row of the vertical line. Enter a value ranging from row 1 through one less than the length of the form. Character row or dot row is specified based on the Scale command (page 95), or use the CP.DP format (page 24).

ER Defines the ending row of the vertical line. Enter a value ranging from row 2 through the last column of the form. The ending row must be greater than the starting row. Character row or dot row is specified based on the Scale command (page 95), or use the CP.DP format (page 24).

STOP Stop indicates the end of the VERT command; enter **STOP**. If not entered, the IGP/PGL expects another set of Vertical Line command parameters.

Example

The following program specifies 4 vertical lines. To illustrate positioning, the starting row and column are indicated on the example but do not necessarily reflect actual location on the page.

```
VERT 2;36;53;61
2;50;53;61
2;60;53;61
2;70;53;61
STOP
```

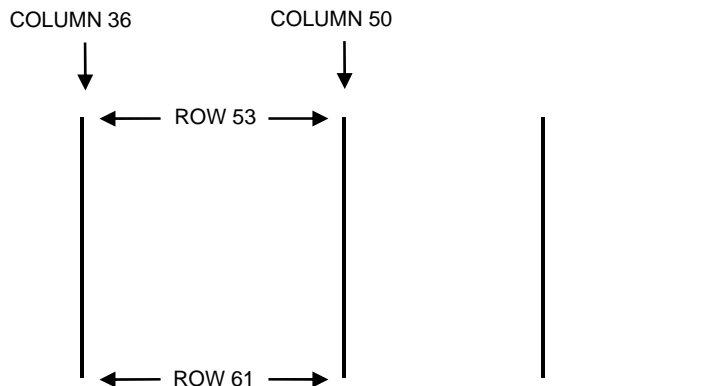

Link

Purpose Prints forms created in the CREATE mode, used exclusively for XML driven forms.

NOTE: The Link command is not supported on all printer models.

Mode NORMAL

Format (cc)LINK;formname[;PAGE_n][;IRST_n];DISK

[EVFU Data]

[(cc)AF_n; (D)ASCII text(D)]

[(cc)BF_n; (D)data(D)]

[(cc)DF_n; (D)data(D)]

[(cc)AF_n; <DF_n>]

[(cc)BF_n; <DF_n>]

[(cc)GF_n; (D)logoname(D)]

[(cc)KF_n; (D)DBCS data(D)]

[(cc)IAF_n; [idir] STEP; [RPT_n;] [RST_n;] (D)STARTDATA(D)]

[(cc)IBF_n; [idir] STEP; [RPT_n;] [RST_n;] (D)STARTDATA(D)]

[(cc)IDF_n; [idir] STEP; [RPT_n;] [RST_n;] (D)STARTDATA(D)]

[Overlay Data]

[Form Feed character]

(cc)NORMAL

LINK Enter LINK. The rest of the parameters are exactly the same as the one listed for ~EXECUTE except for the incremental data; use STEP instead of STEPMASK. This command is exclusively for XML driven forms. When the LINK command is used, the command line ~LINK and the data following it up to ~NORMAL will be saved into flash memory under the same file name with the extension .lnk. When XML data stream prints the form with the same name, the files (.nol, .frm, and .lnk) of the same corresponding name will be retrieved from flash memory and executed in this order. *.nol includes all the command in NORMAL mode, *.frm includes all the command in CREATE mode, and *.lnk includes all the command in EXECUTE mode. *.nol is an optional file for printing XML forms, but both *.frm and *.lnk are required for printing XML forms. See the ~SETUP command on how to save .nol files into flash memory. See the ~CREATE command on how to save .frm files into flash memory.

formname Identifies a previously defined form by name. The form name is not case sensitive.

PAGE_n PAGE_n is the same as the one listed in the ~EXECUTE command. Refer to the ~EXECUTE command for a parameter description.

IRST_n IRST_n is the same as the one listed in the ~EXECUTE command. Refer to the ~EXECUTE command for a parameter description.

DISK Enter DISK to save the LINK file into FLASH. This parameter is required for the LINK command.

[(cc)AF_n; (D)data(D)]

[(cc)BF_n; (D)data(D)]

[(cc)CF_n; (D)data(D)]

data The data will be the tag name defined in XML data file, which will be replaced with the tag value defined in XML data file and be printed as print data on the label.

For incremental dynamic alphanumeric data:

```
(cc)IAFn;[idir] STEP[idir]step;[RPTn;] [RSTn;]
(D)STARTDATA(D)
```

For incremental dynamic barcode data:

```
(cc)IBFn;[idir] STEP[idir]step;[RPTn;] [RSTn;]
(D)STARTDATA(D)
```

For incremental dynamic radio frequency identification data:

```
(cc>IDFn;[idir] STEP[idir]step;[RPTn;] [RSTn;]
(D)STARTDATA(D)
```

STEP Define the step increment or decrement. Use this parameter for incremental dynamic data used in an XML driven form.

STARTDATA The data will be the tag name defined in XML data file, which will be replaced with the tag value defined in XML data file and be printed as print data on the label. The tag value will increment.

Comments

The form count option FC/ICNT/FCNT used in the EXECUTE command is ignored in the LINK command. The form count of XML driven forms is determined by the _QUANTITY attribute in XML data stream.

For XML driven forms, since both SETUP (*.nol) and LINK file (*.lnk) are stored only in FLASH, the user can delete the flash files through the front panel option. (See the SETUP command for a description.)

Example 1

The following is an example of how the ~LINK command works with XML driven forms.

```
~SETUP;ROLL // saved in FLASH as ROLL.nol
~CONFIG
TOP/BOTTOM MARGIN;0
SLASH ZERO;0
HOST FORM LENGTH;0
END
~PAPER;CUT 0;INTENSITY 0;ROTATE 0;SPEED IPS 4;LABELS 2;WIDTH 41
~SETUPEND

~CREATE;ROLL;432;DISK //saved in FLASH as ROLL.fm
ALPHA
IAF1;10;5;5;3;3
AF2;10;10;5;3;3
15;5;3;3;*This is an XML driven form*
STOP
END
~LINK;ROLL;DISK //Saved in FLASH as ROLL.lnk
~IAF1;STEP+1;"employee"
~AF2;*company*

~NORMAL
```

The following is a complete XML data stream which will print three copies of the above form, where “employee” and “company” are the tag names. The tag names will be replaced with the tag value “1234567” and “IBM”. The tag value will print as print data.

```
<?xml version="1.0" standalone="no"?>
<!DOCTYPE labels SYSTEM "label.dtd">
<labels _FORMAT="ROLLJOB" _QUANTITY="3" _JOBNAME="job1">
<label _FORMAT="ROLL">
<variable name="employee">1234567</variable>
<variable name="company">IBM</variable>
</label>
</labels>
```

Listen

Purpose Disables the IGP/PGL from the “quiet” state and enables the IGP/PGL for standard operation. (The Quiet command is explained on page 93.)

Mode NORMAL

Format (cc)LISTEN

(cc) The Special Function Control Code.

LISTEN The Listen command; enter **LISTEN**.

NOTE: When the IGP/PGL is in the quiet state, the currently selected line printer emulation commands are active. Refer to your printer’s *LinePrinter Plus Emulation Programmer’s Reference Manual* for a description of these commands.

Logo Call

Purpose Selects and positions previously defined logo(s). (The logo itself is actually defined separately in the Create Logo mode.) The logo may be defined using TIFF files, PCX raster data, or IGP/PGL dots.

Mode CREATE

Format LOGO

[GF*n*];SR;SC;logoname[;ROT] [;DISK]

STOP

LOGO The Logo Call command; enter **LOGO**.

GF*n* The optional dynamic field for identifying the logo location on the form. If this parameter is used, the actual logo name cannot be entered here; it must be entered dynamically in Execute Form mode (see page 63). Dynamically entering the logo name permits changes to the graphics without redefining the form. To use this field, perform the following steps:

- a. Enter **GF**.
- b. Replace *n* with a number from **0 through 512** to identify the logo location on the form. The *SR* and *SC* parameters are used to specify the exact location of the logo identified by *n*.

<i>SR</i>	Defines the starting row of the logo. The <i>SR</i> (and <i>SC</i>) parameter specifies the location for the logo based on the upper left corner of the grid in which the logo was defined. Enter a value ranging from row 1 through one less than the length of the form. Character row or dot row is specified based on the Scale command (page 95), or use the CP.DP format (page 24).
<i>SC</i>	Defines the starting column of the logo. The <i>SC</i> (and <i>SR</i>) parameter specifies the location for the logo based on the upper left corner of the grid in which the logo was defined. Enter a value ranging from column 1 through one less than the width of the form. Character column or dot column is specified based on the Scale command (page 95), or use the CP.DP format (page 24).
<i>logoname</i>	Identifies a previously defined logo by name for use on the form. Enter the logo name exactly as used to define and store the logo. This logo name is not entered when the <i>GFn</i> parameter is used.
<i>ROT</i>	Optional parameter for images scanned in orientations other than upright. Either <i>CW</i> (for 90 degree clockwise rotation), <i>CCW</i> (for 90 degree counterclockwise rotation), or <i>INV</i> (for Inverted characters; 180 degree rotations), or <i>NOR</i> (for normal rotation). If not specified, the rotation will be the rotation when it is defined in <i>NORMAL</i> mode. When specified, this option will override the rotation option specified in <i>NORMAL</i> mode (with <i>~LOGO</i> command).
<i>DISK</i>	Optional parameter to retrieve the logo from Onboard Flash Memory. Enter DISK . The <i>DISK</i> parameter is not needed for dynamic logos (<i>GFn</i>). The Onboard Flash Memory is automatically searched when the logo name is specified in Execute Form mode. To retrieve the logo from the SD card or Expanded Memory Cartridge, enter EMC . See Flash Memory Storage on page 18.
<i>STOP</i>	Stop indicates the end of the <i>LOGO</i> command; enter STOP , and the IGP/PGL will wait for a new command. If not entered, the IGP/PGL will expect another set of Logo Call command parameters.

Example

The following sample program specifies three logo calls placing the same logo at three different locations. (The logo was previously defined and stored.) The starting row and column specify the upper left corner of the grid in which the logo was defined. To illustrate positioning, the starting row and column are indicated on the example but do not necessarily reflect actual location on the page.

```
LOGO
56 ; 35 ; HAND
56 ; 50 ; HAND
56 ; 65 ; HAND
STOP
```

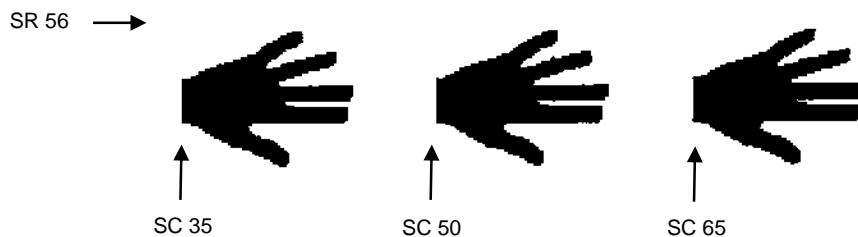

NOTE: When the logo to be executed is not found in memory, the "LOGO NOT FOUND" error is printed.

Logo Mode, Create

Purpose	Places the IGP/PGL in the Create Logo mode, where logos can be defined using the appropriate dot placements. (See TIFF Logo, page 101, and PCX Logo, page 83, commands to define logos using TIFF or PCX data.)
Mode	NORMAL, CREATE
Format	(NORMAL) (cc)LOGO; <i>logoname</i> ; VL; HL [;DOT] [;DISK] <i>row#</i> ; <i>dot</i> ; <i>dot1-dot2</i> ; <i>dot</i> END
Format	(CREATE) LOGODEF; <i>logoname</i> ; VL; HL(T)] <i>row#</i> ; <i>dot</i> ; <i>dot1-dot2</i> ; <i>dot</i> END
	(cc) The Special Function Control Code.
	LOGO The Logo command; enter LOGO .
	LOGODEF The CREATE mode Logo command; enter LOGODEF .
	<i>logoname</i> Enter a maximum of 15 alphanumeric characters for the name of the logo. (Refer to page 22 for a list of allowable Logo Name characters.) All future references to this logo (Delete Logo or Logo Call commands) must use this name. If a logo is defined with the same name as a logo already existing in memory, the newly defined logo will replace the existing logo.
	VL Defines the vertical length of the logo grid in dot rows; enter a value sufficient for the vertical size of the logo, not exceeding 252. The dot rows are vertically spaced 1/72-inch apart.
	HL Defines the horizontal length of the logo grid in dot columns; enter a value sufficient for the horizontal size of the logo, not exceeding 240. On each row, the dots are horizontally spaced 1/60-inch apart.
	DOT Optional parameter. Enter DOTS . If used, the logo description and dimensions VL;HL are given in printer dots, which are based on the printer DPI. Otherwise, the DOT default is 60x72. Also, when the DOT parameter is used, there is no limit on the size of the logo as there is when using IGP dots.
	(T) A line terminator (i.e., LF, FF) must separate the LOGO line from the beginning of the TIFF raster data.
	DISK In NORMAL mode use this parameter to store the logo to Onboard Flash Memory. Enter DISK . Do not use this parameter in CREATE mode. To store the logo in the SD card or Expanded Memory Cartridge, enter EMC . See Flash Memory Storage on page 18.
	<i>row#</i> Identifies the row number for each row of dots in the logo. Enter each row number on a separate command line. Rows are numbered sequentially from top to bottom.
	<i>dot</i> Identifies a single dot position in the row. Enter each dot number used. Dots are numbered sequentially from left to right.

<i>dot1-dot2</i>	Identifies a series of dot positions within the row, including <i>dot1</i> on the left end and <i>dot2</i> on the right end. Enter the series of dot rows. Series of dot rows can be combined with single dot positions in the same command line.
END	Terminates the Create Logo mode; enter END .
STOP	Ends the Create Logo command while the IGP continues in the Create Form Mode. Enter STOP . If STOP is not entered, an error message results.

Comments

The logo is defined by specifying the overall size and the rows of data used. The actual number of logos you can create and store depends on the memory required for each logo.

The maximum logo size allowed is 252 rows high (3.5 inches) and 240 columns wide (4 inches). Values exceeding either of these dimensions will produce an error. To maximize memory space, do not define the vertical and horizontal length of the logo grid larger than is required to capture the design.

The printer produces a grid with 72 dots per inch vertically and 60 dots per inch horizontally. Consequently, a logo must be designed using this scale.

The Logo Call command (page 76) in the Create Form mode brings the predefined logo into a form. The starting row and column parameters refer to the upper left corner of the logo grid. Once created, the logo is ready to be used in any form and will print at the size shown.

Example

The following program produced the tape holder logo.

```

~LOGO;TAPEHOLD;36;40 1;12-18
2;10-20
3;9-22
4;8-24
5;7-25
6;6-26
7;5-26
8;4-25
9;4-25
10;3-24
11;3-24
12;2-23
13;2-23
14;2-14;17-23
15;1-12;19-22;38-39
16;1-12;20-23;37-40
17;1-11;20-23;37-40
18;1-11;20-23;36-40
19;1-11;20-23;36-40
20;1-11;20-23;35-40
21;1-12;20-24;35-40
22;1-12;19-24;34-39
23;1-14;17-25;33-39
24;1-28;31-39
25;1-39
26;2-38
27;2-38
28;2-37
29;3-37
30;3-36

```

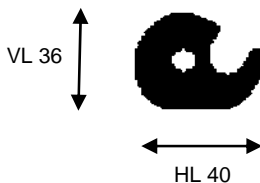

31;3-36
32;4-35
33;5-34
34;6-33
35;7-32
36;9-30
END

Normal Mode

Purpose Places the IGP/PGL in the Normal mode of operation, where the data stream is not changed but monitored for a Special Function Control Code followed by an IGP/PGL command.

Mode NORMAL, EXECUTE

Format (cc)NORMAL

(cc) The Special Function Control Code.

NORMAL The Normal mode command; enter NORMAL.

Comments

Normal mode is entered automatically when the printer is powered on with IGP/PGL. In Normal mode, the IGP/PGL uses the default font and line spacing values, unless otherwise configured with explicit commands.

A blank line or overlay data must always separate an EXECUTE command from a NORMAL command, unless a form count is given for the EXECUTE.

Optimize

Purpose Performs the same function as the front panel menu "Optimize&Reboot." Optimizes the flash file in memory and then reboots.

NOTE: The Optimize command is not supported on all printer models. Some models do not require this function to reclaim flash. If this command is not supported, it will be absorbed.

Mode NORMAL

Format (cc) OPTIMIZE

(cc) The Special Function Control Code

OPTIMIZE The optimize command. Enter OPTIMIZE.

Example

The following example shows the format of optimize command.

~OPTIMIZE

Page Number

Purpose	Defines where a page number is placed on a form and automatically increases the page number on each page.
Mode	CREATE
Format	PAGE;SR;SC
	PAGE The Page Number command; enter PAGE .
	SR Defines the starting row of the page number. Enter a value ranging from row 1 through one less than the length of the form. Character row or dot row is specified based on the Scale command (page 95), or use the CP.DP format (page 24).
	SC Defines the starting column of the page number. Enter a value ranging from column 1 through one less than the width of the form. Character column or dot column is specified based on the Scale command (page 95), or use the CP.DP format (page 24). If the SR or SC extends beyond the page boundaries, an Error 76 will occur in the Execute Form mode, and default page number SR SC values (row 1, column 1) are used.

Comments

To begin automatically incrementing the page numbers, the starting page number must be specified during the Execute command.

Example

The following command places the page numbers at row 60 column 70 on the form.

```
PAGE;60;70
```

Paper

Purpose Controls printer paper options, such as page orientation, intensity and ribbon use.

Mode NORMAL, EXECUTE, CREATE

NOTE: More than one option may follow the paper command.

Format (cc)PAPER[;option[#]]

NOTE: Not all options may be available with your printer. Consult your *Administrator's Manual* to determine which options are available. If an option is not available, the emulation will ignore the corresponding command.

(cc) The Special Function Control Code.

NOTE: SFCC should not be used in the CREATE mode.

Checkmarked cells in Table 9 means full compatibility for all applicable models in the line matrix product lines. If the columns are left blank, the command is ignored for the given product line. If individual models are listed, the commands are supported only on those listed models.

Table 9 Paper Parameters

Paper Parameter	Description	Line Matrix
ABORT	Stops printing all remaining pages in the engine and flushes all partial job in progress. Enter ABORT .	✓
EJECT	Prints all pages that are in the buffer. Enter EJECT .	✓
LENGTH #	Specifies the length of the form in tenths of an inch. Enter LENGTH , a space, and number from 1 through 9999 .	✓
PORTRAIT	Prints in portrait mode. Enter PORTRAIT .	✓
WIDTH #	Specifies the width of the form in tenths of an inch. Enter WIDTH , a space, and number from 1 to 9999 .	✓

Comments

You can use any or all Paper parameters, listed in any order, in a single Paper command. (Do not list any parameters on separate lines.) Parameters not specified or specified incorrectly retain the previously selected value. All Paper command parameters are reset to default values upon receiving a RESET command. Multiple paper commands within a single form will save the *last* paper command parameters specified.

Changing orientation between Portrait and Landscape may cause previously defined forms to produce boundary error messages when the form is executed because width and height values are switched.

Example

Based on power-up printer defaults, the following command selects the inverted portrait orientation.

```
~PAPER;ROTATE 180
```

Paper Instruction - Data Bit 8

Purpose Enables or disables data bit 8 as the paper instruction signal when the IGP/PGL is configured for a serial interface. (This command has no effect on a parallel interface.)

Mode NORMAL

Format (cc)PION or (cc)PIOFF

(cc) The Special Function Control Code.

PION The Data Bit 8 Paper Instruction On command; enter **PION**. When this command is sent, 7 data bits are allowed; data bit 8 is enabled as the paper instruction.

When data bit 8 is set high, the PION command skips to a specified print line. When data bit 8 is set low, the PION command prints data characters.

PIOFF The Data Bit 8 Paper Instruction Off command; enter **PIOFF**. When this command is sent, 8 data bits are allowed for character data because data bit 8 is disabled as the paper instruction. Subsequent occurrences of data bit 8 in the data stream cause printing from the extended character set.

Paper Instruction (PI) Enable/Disable

Purpose	Enables or disables use of the PI line using a parallel I/O device. (This command does not enable/disable PI line sensing; it enables or disables use of the “sensed” PI line.)
Mode	NORMAL
Format	(cc)EN-PI or (cc)DIS-PI
(cc)	The Special Function Control Code.
EN-PI	The Enable PI command; enter EN-PI . When this command is enabled, the IGP/PGL senses PI line, the 8 bits of data are interpreted as a paper instruction command, and the PI line itself is ignored.
DIS-PI	The Disable PI command; enter DIS-PI . When the Disable PI command is sent, the 8 bits of data are interpreted as printable characters, and not as a paper instruction command.

PCX Logo

Purpose	Places the IGP/PGL in the Create Logo mode, where logos can be defined using the PCX file format.
Mode	NORMAL, CREATE
Format	(NORMAL) (cc)LOGO; <i>logoname</i> ;PCX[;TRIM][;ROT][;DISK] <i>PCX raster data</i> (cc)RASTEREND END
Format	(CREATE) LOGODEF; <i>logoname</i> ;PCX[;TRIM][;ROT] (T) <i>PCX raster data</i> (cc)RASTEREND STOP

NOTE: The logos defined in CREATE mode are independent of the forms being defined at the same time. The logo can be used by other forms, and must be deleted by using the ~RESET or ~DELETE LOGO command.

(cc)	The Special Function Control Code.
LOGO	The Logo command; enter LOGO .
LOGODEF	The CREATE mode LOGODEF command; enter LOGODEF .
<i>logoname</i>	Enter a maximum of 15 alphanumeric characters for the name of the logo. (Refer to page 22 for a list of allowable Logo Name characters.) All future references to this logo (Delete Logo or Logo Call commands) must use this name. If a logo is defined with the same name as a logo already existing in memory, the newly defined logo will replace the existing logo.
PCX	The command denoting raster data in PCX format; enter PCX .
TRIM	Optional parameter that removes extra white space bounding the image, which saves memory inside the printer. Also helps position the image in an IGP/PGL form. Enter TRIM .
ROT	Optional parameter for images scanned in orientations other than upright. Enter either CW (for 90 degrees clockwise rotation), CCW (for 90 degree counterclockwise rotation), or INV (for inverted characters; 180 degrees rotations.) (This parameter is not for printing rotated logos but rather for handling scanned rotated images. Logos are rotated

automatically to match the current page orientation when they are called from an IGP/PGL form being executed.)

DISK Optional parameter to store the logo to Onboard Flash Memory. Enter **DISK**. Do not use this parameter in CREATE mode. To store the logo in the SD card or Expanded Memory Cartridge, enter **EMC**. See Flash Memory Storage on page 18.

(T) A line terminator (i.e., LF, FF) must separate the LOGO line from the beginning of the PCX raster data.

PCX raster data

Scanned data in PCX format; data must be black and white. Grey scales or color PCX files are currently not supported. Both uncompressed and compressed formats are supported.

(cc) The Special Function Control Code.

RASTEREND Denotes the end of the PCX raster data. Enter **RASTERENDEND**.

END Terminates the PCX logo; enter **END**.

STOP Ends the Create Logo command while the IGP continues in the Create Form Mode. Enter **STOP**. If STOP is not entered, an error message results.

Comments

The size and number of raster image logos are bounded by printer memory. Also note that each rotation used requires a copy of the image; therefore, the number of rotations used affects the printer memory available.

The logo call command in the Create Form mode brings the predefined logo into a form. The starting row and column parameters refer to the upper left corner of the logo grid. Once created, the logo is ready to be used in any form.

Raster images may contain data that is interpreted by your host as control codes. This may affect the way the host sends data to the printer. Consult your host's *Administrator's Manual* for sending binary data.

Be careful when editing PCX output files because most TEXT editors insert carriage returns and line feeds. If a PCX file must be edited, use a binary or hex editor.

NOTE: The LOGO line must be terminated with an LF (hex 0A) or FF (hex 0C), and then immediately followed by the PCX raster data. The IGOON and IGOFF commands can be used with the PCX raster data to ignore extraneous control or ASCII characters.

PNG Logo

Purpose Places the IGP/PGL in the Create Logo mode, where logos can be defined using the PNG file format.

Mode NORMAL, CREATE

Format (NORMAL)
(cc)LOGO;*logoname*;PNG[;TRIM][;ROT][;DISK]
PNG raster data (cc)RASTEREND
END

Format (CREATE)
LOGODEF;*logoname*;PNG[;TRIM][;ROT] (T)
PNG raster data (cc)RASTEREND
STOP

NOTE: The logos defined in CREATE mode are independent of the forms being defined at the same time. The logo can be used by other forms, and must be deleted by using the ~RESET or ~DELETE LOGO command.

(cc)	The Special Function Control Code.
LOGO	The Logo command; enter LOGO .
LOGODEF	The CREATE mode LOGODEF command; enter LOGODEF .
<i>logoname</i>	Enter a maximum of 15 alphanumeric characters for the name of the logo. (Refer to page 22 for a list of allowable Logo Name characters.) All future references to this logo (Delete Logo or Logo Call commands) must use this name. If a logo is defined with the same name as a logo already existing in memory, the newly defined logo will replace the existing logo.
PNG	The command denoting raster data in PNG format; enter PNG .
TRIM	Optional parameter that removes extra white space bounding the image, which saves memory inside the printer. Also helps position the image in an IGP/PGL form. Enter TRIM .
<i>ROT</i>	Optional parameter for images scanned in orientations other than upright. Enter either CW (for 90 degrees clockwise rotation), CCW (for 90 degree counterclockwise rotation), or INV (for inverted characters; 180 degrees rotations.) (This parameter is not for printing rotated logos but rather for handling scanned rotated images. Logos are rotated automatically to match the current page orientation when they are called from an IGP/PGL form being executed.)
DISK	Optional parameter to store the logo to Onboard Flash Memory. Enter DISK . Do not use this parameter in CREATE mode. To store the logo in the SD card enter EMC . See Flash Memory Storage on page 18.
(T)	A line terminator (i.e., LF, FF) must separate the LOGO line from the beginning of the PNG raster data.
<i>PNG raster data</i>	Scanned data in PNG format; data must be black and white. Grey scales or color PNG files are currently not supported.
(cc)	The Special Function Control Code.
RASTEREND	Denotes the end of the PNG raster data. Enter RASTEREND .
END	Terminates the PNG logo; enter END .
STOP	Ends the Create Logo command while the IGP continues in the Create Form Mode. Enter STOP . If STOP is not entered, an error message results.

Comments

The size and number of raster image logos are bounded by printer memory. Also note that each rotation used requires a copy of the image; therefore, the number of rotations used affects the printer memory available.

The logo call command in the Create Form mode brings the predefined logo into a form. The starting row and column parameters refer to the upper left corner of the logo grid. Once created, the logo is ready to be used in any form.

Raster images may contain data that is interpreted by your host as control codes. This may affect the way the host sends data to the printer. Consult your host's *Administrator's Manual* for sending binary data.

Be careful when editing PNG output files because most TEXT editors insert carriage returns and line feeds. If a PNG file must be edited, use a binary or hex editor.

NOTE: The LOGO line must be terminated with an LF (hex 0A) or FF (hex 0C), and then immediately followed by the PNG raster data. The IGON and IGOFF commands can be used with the PNG raster data to ignore extraneous control or ASCII characters.

Print File

Purpose Prints files from the Onboard Flash Memory. Print File can be used to show the SETUP functions that exist.

Mode NORMAL

Format (cc)PRINT;*filename*

(cc) The Special Function Control Code.

PRINT The Print File command; enter **PRINT**.

filename The filename to be printed.

Comments

Do not use wildcard characters because the Print File command will attempt to print any file in the Onboard Flash Memory.

Example

Example of how to print SETUP.PTR:

```
~PRINT ; SETUP . PTR
```

Printer Alert

Purpose To set the printer alert condition. After the alert condition is set and the condition event occurs, the printer responds immediately with an alert message for the corresponding condition. The alert message is sent back to the host.

Mode NORMAL

Format (cc) ALERT; TYPE n; DEST n; SET n; CLEAR n

(cc) The Special Function Control Code. ALERT The printer alert command. Enter ALERT.

TYPE n The condition type. Enter TYPE, a space, and a letter from the following list:

A = paper out

I = defaulted printer

K = printer paused

L = batch job completed

O = runtime error

P = forced error

b = binary flags

- DEST n The destination to route alert to. Enter DEST, a space, and a letter:
 A = serial port
 B = ethernet data port
 C = ethernet status port
 R = Return Status Port (return port determined by FP setting)
- SET n Enable condition set alert. Enter SET, a space, and 1 to enable or 0 to disable.
- CLEAR n Enable condition clear alert. Enter CLEAR, a space, and 1 to enable or 0 to disable.

Comment

Currently, only the condition type L (batch job completed) and b (binary flags) are supported.

Example 1

The following example shows the format of printer alert command, where the printer responds with an alert message "BATCH JOB NOT COMPLETED" before the job is completed, and an alert message "BATCH JOB COMPLETED" when the batch job is completed. The alert message is sent back to the host through Serial.

~ALERT; TYPE L; DEST A; SET 1; CLEAR 1

Example 2

The following example shows the alert command format in which the printer will respond with an alert message whenever one of the supported states change. The alert message is sent to the host through the port selected by the 'Ret. Status Port' FP setting.

NOTE: The CLEAR setting will have no effect on this alert type. The response send will always be 10 bytes long. The meaning of the status bytes is explained in the table below.

~ALERT;TYPE b;DEST R;SET 1;CLEAR 0

Status Byte	Bit	Status	Description
Byte 0	7..0	Response Start Marker	STX character
Byte 1	7	Online	1 = printer online, 0 = printer offline
	6	Error	1 = error , 0 = no error
	5	Not Used	Always 1
	4	Processing	1 = processing, 0 = not processing
	3	Printing	1 = printing, 0 = not printing
	2	Power Save	1 = in power save mode, 0 = not in power save mode
	1	Warning	1 = warning state, 0 = no warning state
	0	FEXP	For Future Expansion

Status Byte	Bit	Status	Description
Byte 2	7	Print Head Open	1 = print head open, 0 = print head closed
	6	Paper	1 = paper out, 0 = no paper out
	5	Not used	Always 1
	4	Ribbon Out	1 = ribbon out, 0 = no ribbon out
	3	Cutter Fault	1 = cutter fault, 0 = no cutter fault
	2	ODV max retry fail	1 = max retry fail, 0 = no max retry fail
	0	TOF Detect Fault	1 = TOF detect fault, 0 = no TOF detect fault
Byte 3	7	Ribbon Low	1 = ribbon low, 0 = no ribbon low
	6	FEXP	For Future Expansion
	5	Not used	Always 1
	4	FEXP	For Future Expansion
	3	FEXP	For Future Expansion
	2	FEXP	For Future Expansion
	1	FEXP	For Future Expansion
	0	FEXP	For Future Expansion
Byte 4	7	Label Fed	1 = label fed, 0 = no label fed
	6	Label OK	1 = label OK, label not OK
	5	Not used	Always 1
	4	Label Failed	1 = label failed, 0 = label not failed
	3	Label Present	1 = label present, 0 = label taken
	2	Label Cut	1 = label cut, 0 = no label cut
	1	FEXP	For Future Expansion
	0	FEXP	For Future Expansion
Byte 5..8	7..0	FEXP	Bit 5 always 1
Byte 9	7..0	Response End Marker	ETX character

Printer Identification

Purpose To request the printer identification. When the command is sent to the printer, the information containing the printer identification is sent back to the host. The information contains the model, software version, dots per millimeter setting, and memory size.

Mode NORMAL

Format (cc) IDENTITY

(cc) The Special Function Control Code

IDENTITY The printer identification command. Enter IDENTITY.

Command

When the printer receives this command it will return the information to the host as such:

V1.16K = software version

12= dots/mm

512KB = memory

Example

The following example shows the format of printer identification command.

~IDENTITY

Printer Mode

Purpose Selects the print mode of the printer for the next set of data and allows different print modes to be specified for use within the form.

Mode CREATE

Format PMODE; *type* [;*width*][;*rmode*]

MODE;SR

.....

STOP

PMODE The Printer Mode command. Enter **PMODE**. The PMODE command must be the first command entered following the CREATE command.

type Indicates the type of printer used with the IGP/PGL. Enter L to specify L150 or L150B printers, enter S to specify standard MVP and MVP 150B printers, 3 to specify P3000 printers, 6 to specify P6000 printers, and 9 to specify P9000 printers.

width An optional parameter specifying a forms width of 136-character columns. Currently, this parameter is not supported; the default value forms width is 132 character columns.

rmode An optional parameter specifying the "return mode" of the printer following the Execute Form Mode. Enter **1, 2, 3, 4, or 5** to specify printer modes 1 through 5, respectively. If this mode is not specified, the printer remains in the mode effective at the end of the Execute Form Mode. The return print mode is effective when new data is received following the Execute Form Mode.

MODE	<p>Specifies up to 8 different print modes to be used within the form beginning on the row defined by the SR parameter. Enter the appropriate print mode number. This mode will remain effective within the form until a new print mode is defined by another MODE;SR sequence or the end of form is reached.</p> <p>As described in your printer <i>Administrator's Manual</i>, print densities and maximum line lengths vary with each print mode. Form elements such as boxes or vertical lines may be printed at varying densities or suffer horizontal compression due to a print mode change in the body of the form.</p>
SR	<p>Defines the starting row of the print mode used within the form. The row number can range from 1 to one less than the length of the form. Character row or dot row is specified based on the Scale command, which refers to the SMODE command table of densities (page 97), or use the CP.DP format (page 24).</p>

Comments

The PMODE command is useful for ensuring the printer is set for the proper print mode to print bar codes or alphanumeric data. Up to eight *MODEs* can be specified within one PMODE command.

Horizontal compression of elements occurs when the print mode is changed to a mode with a different density. For example, on an L150 printer, a box is constructed using print mode 2 (density of 60 dpi/10 cpi horizontal) for standard data processing applications. The *SR* and *SC* parameters of the box command produce a box 6 inches wide (6 inches at 60 dpi = 360 dots, or 6 inches at 10 cpi = 60 character spaces). If the same box is generated in print mode 4 (density of 72.5 dpi/12.1 cpi horizontal) for a bar code application, the box will be compressed to an approximate width of 4.9 inches due to the higher dot density of print mode 4 (360 dots at 72.5 dpi = 4.9 inches).

To compensate for the compression, modify the program generating the form elements to accommodate the dot density of the new print mode. To produce the 6-inch wide box at the 72.5 dpi horizontal print mode, the box *SR* and *SC* parameters must be modified to accommodate 435 dots (6 inches at 72.5 dpi = 435 dots, or 6 inches at 12.1 cpi = 72.6 character spaces). Starting and ending row and column data must be calculated in terms of character or dot scaling, based on the IGP/PGL Scale command (page 95). This type of horizontal compression is illustrated in Example 2, below.

Example 1

The following sample program places an L150 printer in Mode 4 beginning on form line number 1 (to print bar codes, for example) and places the printer in Mode 2 upon receipt of new data after the form is executed.

```
~CREATE;EXAMPLE
PMODE;L;2
4;1
STOP
```

Example 2

In the following horizontal compression examples, starting and ending row and column information is provided for reference and does not reflect the exact location on the page. Character scaling is used. The example below illustrates a 6-inch wide box in L150 Mode 2; the next example illustrates the same box (compressed) in L150 Mode 4; and the last example illustrates a modified box command to produce a 6-inch wide box in L150 Mode 4.

```
~CREATE;BOX          (Create Mode command)
PMODE;L;2           (PMODE command for L150, return to Mode 2)
2;1                 (Begin Mode 2 at form line 1)
STOP                (Stop PMODE command)
BOX                 (Box command)
2;20;5;22;65       (6-inch box, 60 characters at 10 cpi)
STOP                (Stop box command)
END                 (End Create Mode)
~EXECUTE;BOX
```



```
~CREATE;BOX          (Create Mode command)
PMODE;L;2           (PMODE command for L150, return to Mode 2)
4;1                 (Begin Mode 4 at form line 1)
STOP                (Stop PMODE command)
BOX                 (Box command)
2;20;5;22;65       (60 char. spaces, but now in Mode 4, 12.08 cpi)
STOP                (Stop box command)
END                 (End Create Mode)
~EXECUTE;BOX
```



```
~CREATE;BOX          (Create Mode command)
PMODE;L;2           (PMODE command for L150, return to Mode 2)
4;1                 (Begin Mode 4 at form line 1)
STOP                (Stop PMODE command)
BOX                 (Box command)
2;20;5;22;77.5     (6-inch box, 72.5 characters at 12.08 cpi)
STOP                (Stop box command)
END                 (End Create Mode)
~EXECUTE;BOX
```

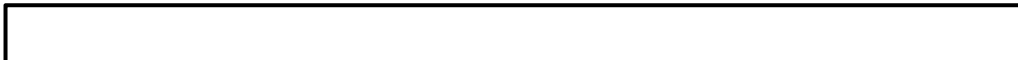

Printer Status

Purpose	To request the printer status. When the printer status command is sent to the printer, data containing the printer status is sent back to the host.	
Mode	NORMAL	
Format	(cc) STATUS	
	(cc)	The Special Function Control Code.
	STATUS	The printer status command. Enter STATUS.

Comments

1. The printer status command will take effect when a snoop (preparser) is enabled. Any of the following commands will enable the snoop for all ports. You can also enable preparser by using the front panel. Send the following command to the printer before sending the job.

```
~CONFIG  
SNOOP;STATUS;PAR  
END
```

```
~CONFIG  
SNOOP;STATUS;ETH  
END
```

```
~CONFIG  
SNOOP;STATUS;SER  
END
```

The STATUS command works if it is received from any port. PAR, ETH, and SER are listed as compatible with old PGL commands.

To disable a snoop, send the following command to the printer before sending the job.

```
~CONFIG  
SNOOP;OFF  
END
```

2. After the snoop is enabled, the printer status command can be sent to the printer through any port.
3. When the printer status command is sent to the printer, a data string is sent back to the host through the serial port in the following format:

```
~STATUS  
BUSY;n                (n=0 no data in buffer, n=1 data in buffer)  
COUNT;n             (n = the number of pages that remains to be printed)  
END
```

The status response values depends on the printer model. If the status value is not supported by a printer model it will return 0 for that status value.

Example

The following example shows the format of the printer status command.

```
~STATUS
```

Quiet

Purpose	Places the IGP/PGL in the Quiet mode, where all data passed to the LP+ emulation is unaffected by IGP/PGL commands except for the LISTEN, SFON/SFOFF, IGON/IGOFF and PTX_SETUP commands, or another QUIET command.	
Mode	NORMAL	
Format	(cc)QUIET	
	(cc)	The Special Function Control Code.
	QUIET	The Quiet command; enter QUIET . The IGP/PGL remains in the quiet state until the Listen command is received.

Comments

In the Quiet mode IGP/PGL ignores all commands except LISTEN, SFON/SFOFF, IGON/IGOFF, PTX_SETUP or another QUIET command. All commands for the currently selected protocol in the LinePrinter+ will be interpreted. See the *LinePrinter Plus Programmer's Reference Manual* for details.

The IGP/PGL remains quiet until the LISTEN command (page 76) enables standard IGP/PGL operation. The Quiet command is ignored if the IGP/PGL is in the Execute Form mode. The Quiet command is ignored for printers that do not have the LP+ emulation resident.

Recall

Purpose	Loads the user pre-stored program setup file, SETUP.PTX, from the Onboard Flash Memory into the printer. This is done without sending a system reset.	
Mode	NORMAL	
Format	(cc)RECALL[;filename]	
	(cc)	The Special Function Control Code.
	RECALL	The Recall command; enter RECALL .
	filename	The name of the file to recall. This parameter is optional. If not present, the default file SETUP.PTX is loaded.

Comments

The file SETUP.PTX is also automatically recalled into the printer upon a RESET command.

Repeat

Purpose	Used during EXECUTE mode to repeat a form a given number of times including all the dynamic data. This command is ignored if the Form Count or incremental parameter is used in the EXECUTE command.	
Mode	EXECUTE	
Syntax	(cc)REPEAT;n	
	REPEAT	The REPEAT command. Enter REPEAT.
	n	The number of times to repeat the form with the same dynamic data.

Comments

When a REPEAT command is encountered in EXECUTE mode, PGL will store the repeat count. Actual printing of the form will not be initiated by the REPEAT command. The form will be printed repeatedly (depending on the repeat count) with the same dynamic data after a NORMAL (or FF) command is encountered. Incremental data will be automatically incremented/decremented after each form. There are

no limits to the number of times the REPEAT command can be used within any given EXECUTE sequence. Overlay text will not be repeated.

Reset

Purpose	Deletes all forms and logos from IGP/PGL memory. The Reset performs the following tasks: <ul style="list-style-type: none">• Prints any objects in the current page• Selects the portrait orientation• Deletes all forms and logos resident in memory• Sets the font to the default Gothic 12 point/10CPI• Releases all user-defined character mappings• Runs the SETUP.PTX file if present
Mode	NORMAL, CREATE, or EXECUTE
Format	(cc)RESET
	(cc) The Special Function Control Code.
	RESET The Reset command; enter RESET .

Reverse Print

Purpose	Defines an area of the form where form elements are reverse printed (white on black).
Mode	CREATE
Format	REVERSE
	[DARK;]SR;SC;ER;EC
	STOP
REVERSE	The Reverse Printing command; enter REVERSE .
DARK	Optional parameter to select a denser black background. Enter DARK , or D , to select the denser background. More information about dark printing is provided on page 52.
SR	Defines the starting row of the reverse print field. Enter a value ranging from row 1 through one less than the length of the form. Character row or dot row is specified based on the Scale command (page 95), or use the CP.DP format (page 24).
SC	Defines the starting column of the reverse print field. Enter a value ranging from column 1 through one less than the width of the form. Character column or dot column is specified based on the Scale command (page 95), or use the CP.DP format (page 24).
ER	Defines the ending row of the reverse print field. Enter a value ranging from row 2 through the last row of the form. The ending row must be greater than the starting row. Character row or dot row is specified based on the Scale command (page 95), or use the CP.DP format (page 24).

EC	Defines the ending column of the reverse print field. Enter a value ranging from column 2 through the last column of the form. The ending column must be greater than the starting column. Character column or dot column is specified based on the Scale command (page 95), or use the CP.DP format (page 24).
STOP	Stop indicates the end of the REVERSE command; enter STOP , and the IGP/PGL will wait for a new command. If not entered, the IGP/PGL will expect another set of Reverse Print command parameters.

Comments

You can use reverse print with all form elements (alpha, lines, boxes, etc.). The IGP/PGL can also reverse print bar codes, but reverse printed bar codes are unreadable by bar code scanning devices.

Scale

Purpose	Defines the vertical line spacing and the horizontal pitch of the form for data positioning specified by character row and column or dot row and column.
Mode	CREATE
Format	SCALE;DOT[;horz;vert] or SCALE;CHAR[;lpi] [;cpi] or SCALE;MM
SCALE	The Scale command; enter SCALE .
DOT	Specifies the dot scale. Enter DOT .
horz/vert	Gives resolution for the dot parameter. Default is 60 dpi (horizontal) by 72 dpi (vertical).
CHAR	Specifies the character scale. Enter CHAR .
MM	Specifies the scale will be in millimeters. Enter MM .
lpi	The optional vertical line spacing parameter (in lines per inch) for character scaling. Enter: any integer value from 1 through 1000 . The default is 6 lpi. For line matrix printers, enter 6, 8, 9, or 10.
cpi	The optional horizontal pitch parameter (in characters per inch) for character scaling. Enter 10, 12, 13, 15, 17, or 20 . The default is 10 cpi.

Comments

If the character scale is selected, starting row/column or ending row/column parameters are specified by character row and column. The lines per inch (lpi) value for a character scale form can be set to any integer value from 1 through the target DPI. Characters per inch (cpi) horizontally can be either 10, 12, 13, 15, 17, or 20. For example, on a printer with a maximum print width of 80 columns, an 8-1/2 x 11-inch form at the 6 lpi 10 cpi default has 66 rows and 80 columns in the character scale. (Refer to your printer *Administrator's Manual* to determine your maximum print boundaries.)

If the dot scale is selected, the parameters are specified in dot row and column. For example, based on a 60 dpi horizontal and 72 dpi vertical dot scale, a form of 8-1/2 x 11 inches has 792 rows (72 dpi x 11 inches) and 510 columns (60 dpi x 8-1/2 inches), and a form of 8 x 11 inches has 792 rows and 480 columns. Refer to Appendix 0 for more information about maximum values with other paper sizes.

The default scale factor uses character row and column (6 lpi and 10 cpi). Anytime CP.DP format (page 24) is used, the scale assumes 6 lpi and 10 cpi and a 60 x 72 dpi format.

You can change the Scale at any time during forms creation by using either of the Scale commands. Elements designed before the scale change will print at the former scale, while those elements following the scale change will print at the current scale.

NOTE: Scale affects data position, not the printed data itself. For example, alphanumeric data printed at 10 cpi will still print at 10 cpi after a Scale change; however, where the data is placed on the page is affected. Also, Scale affects line thickness if dot scale and horizontal/vertical scaling are given.

Scaling

Purpose	Permits graphic elements (such as corners or boxes) to retain their physical shapes and sizes when printed in a horizontal and vertical density other than the base density of 60 x 72 dpi (60 horizontal x 72 vertical dots per inch). This command allows IGP/PGL programs developed for other printers to be automatically scaled for execution on MVP and P3000 Series printers so that the printed output appears the same as the original output.
Mode	CREATE
Format	SMODE; <i>pt</i> ; <i>sm</i> [; <i>em</i>]
	SMODE The Scale command; enter SMODE .
	<i>pt</i> Defines the printer type. Enter one of the Printer Type codes shown in Table 10 to select the type of printer.
	<i>sm</i> Defines the scale mode. Enter one of the Scale Mode codes shown in Table 10 to select the scaling mode and corresponding dot density.
	<i>em</i> Optional parameter to define the exit mode. This optional parameter is useful when the normal print mode is different from the print mode used for IGP/PGL graphics. The exit mode returns the IGP/PGL to a specified printer mode after the form is printed. Enter a new Scale Mode code (according to the printer type selected) from Table 10.

Comments

Dot density varies by printer mode. Selecting a different printer mode selects a different horizontal and vertical dot density. This varying density can affect graphic elements created in one particular mode but printed in a different mode. Be sure that graphic elements designed in the IGP/PGL Create Form Mode are defined using a base density of 60 x 72 dpi so that the SMODE command will produce the desired results.

The following application rules must be considered when using SMODE:

- a. When used in the Create Form mode, the SMODE command must be the first command on the line, or an error will occur.
- b. All input parameters of the element being defined (starting/ending row, line thickness, bar code height, etc.), will be scaled according to the dot density of the scale mode selected.
- c. All graphic elements (such as vertical, horizontal, boxes, etc.), except for logos, will be scaled.
- d. All alphanumeric strings with expanded characters (not normal 10 cpi characters) will be scaled.
- e. All input parameters of a bar code, except horizontal span, will be scaled.

Table 10 Printer Modes and Densities

Printer Type Code	Printer Type Selected	Scale Mode Code	Printer Mode	Dot Density (H x V dpi)
S	MVP and MVP 150B	1	1	100 x 96
		2	2	60 x 72
		3	3	60 x 64
		4	4	50 x 48
		5	5	100 x 72
L	L150	1	1	100 x 96
		2	2	60 x 72
		3	3	60 x 64
		4	4	72.5 x 72
		5	5	80 x 72
3	P3000	1	1	90 x 96
		2	2	60 x 72
		3	3	60 x 48
		4	4	72.5 x 72
		5	5	80 x 72
6	P6000	1	1	60 x 144
		2	2	60 x 72
		3	3	60 x 48
		4	4	60 x 72
		5	5	60 x 72
9	P9000	1	1	90 x 96
		2	2	60 x 72
		3	3	60 x 48
		4	4	60 x 72
		5	5	60 x 72

NOTE: MVP and MVP 150B printers must be in Scale Mode 2 and Printer Mode 2 to produce readable bar codes. L150 printers must be in Scale Mode 4 and Printer Mode 4 to produce readable bar codes, except for UPC-A, EAN 8 and EAN 13, which require Mode 5 to produce readable bar codes.

Example

The following scaling command selects a P9000 printer (printer type = 9), a 60 x 72 scale mode (scale mode = 2), and a 60 x 48 exit mode (scale mode = 3). The Create Form command is used to enter the Create Form Mode using a form name of SCALE.

```
~CREATE;SCALE
SMODE;9;2;3
(form elements defined here)
END
~EXECUTE;SCALE;1
```

Select Format

Purpose	Enables the IGP/PGL to ignore all host-generated paper movement commands (hex 00-1F).
Mode	NORMAL, CREATE or EXECUTE
Format	(cc)SFON or (cc)SFOFF

NOTE: A line terminator is not required in the Select Format Sequence.

(cc)	The Special Function Control Code.
SFON	The Select Format On command. Enter SFON.
SFOFF	Exits Select Format. Enter SFOFF .

Comments

During Select Format, you may enter the following IGP/PGL paper movement commands. All the commands must be entered in UPPERCASE. These commands can only be used with the Select Format command. If used at any other time, an error condition may result.

Command	Paper Movement Function
(cc)CR	Sends a carriage return (hex 0D)
(cc)LF	Sends a line feed (hex 0A)
(cc)FF	Sends a form feed (hex 0C)
(cc)LT	Sends a no motion line terminator (hex 03)

Although the Select Format command enables the IGP/PGL to ignore all host-generated paper movement commands, you can input IGP/PGL paper movement commands with Select Format on.

SFON/SFOFF cannot be used during Ignore Sequence (page 70).

Set The Time or Date

Purpose To set the internal printer clock to the current time and date. All the parameters are optional.

NOTE: Since this command sets time, it is important that it is received and processed by the printer quickly. This command should be sent when the printer is online and no other data is in the buffer.

Mode	NORMAL
Format	(cc)SETCLOCK;[DA <i>nn</i> ;] [MO <i>nn</i> ;] [YE <i>nnnn</i> ;] [HO <i>nn</i> ;] [MI <i>nn</i> ;] [SE <i>nn</i> ;]
SETCLOCK	The Set Clock command
DA	Sets the day of the month. Enter DA followed by a space then a two-digit value from 00–31.
MO	Sets the month. Enter MO followed by a space then a two-digit value from 01–12.
YE	Sets the year. Enter YE followed by a space then a four digit value from 0000–9999.
HO	Sets the hour. Enter HO followed by a space then a two-digit value from 00–23.

MI	Sets the minutes. Enter MI followed by a space then a two-digit value from 00–59.
SE	Sets the seconds. Enter SE followed by a space then a two-digit value from 00–59.

Example

See Clock Element Format on page 43.

Setup

Purpose	The SETUP command can be used in two different ways, with the formname and without the formname. When the formname is not entered, the given data under SETUP will be stored into FLASH under the name setup.ptx. This file is then loaded from FLASH and processed as host data whenever printer power is applied or when the RESET or RECALL command is sent. When the formname is entered, SETUP is currently being used in XML driven form to save all commands in NORMAL mode into a FLASH file with the extension .nol, and later to be processed along with two other FLASH saved files, *.frm and *.lnk to print an XML form.
Mode	NORMAL
Format	(cc)SETUP [<i>formname</i>] [<i>DISK</i>] <i>host data</i> (cc)SETUPEND (cc) The Special Function Control Code. SETUP The Setup command; enter SETUP . <i>formname</i> This is a parameter used exclusively for XML driven form. When the formname is entered, the host data following ~SETUP and up to ~SETUPEND will be saved into FLASH under the same formname with the extension, *.nol. The data following SETUP can be only the commands in NORMAL mode. When XML data stream comes in to print the form under the same formname, the file with the same name and extension, .nol will be retrieved from the FLASH and executed along with two other FLASH file of the same name, *.frm (CREATE form) and .lnk (LINK form). See the description and example listed for the ~LINK command, on page 74. The form name is not case sensitive. DISK Optional parameter to store the file to Onboard Flash Memory. Enter DISK . Enter EMC to store the file to the SD card. When the option is not specified, it stores the file to Onboard Flash Memory by default. See Flash Memory Storage on page 18. <i>host data</i> When the parameter formname is not entered, the host data can be any IGP/PGL command, form definition, text, etc. to be stored and executed at power-up. However, when the parameter formname is entered, the host data can only be any IGP/PGL command in NORMAL mode. SETUPEND Finishes storing host data and returns the printer to the NORMAL mode. Enter SETUPEND .

Comments

When SETUP is used for non-XML driven form, the formname is not given because the RESET command causes the setup routine to be executed, the RESET command cannot be in the SETUP information or an infinite loop will occur.

If IGP/PGL commands have not been added between the SETUP and SETUPEND commands, the SETUP.PTX file on the Onboard Flash Memory automatically deletes, and no IGP/PGL SETUP commands execute upon printer power-up.

SETUP.PTX is automatically created by the IGP/PGL when the ~SETUPEND command is received. When the SETUP.PTX file is not in the Onboard Flash Memory, no extra IGP/PGL commands are performed on power-up.

When SETUP is used for XML driven form (the formname is given), the DELETE FORM command (*.frm) used under SETUP to delete both FLASH or DRAM form cannot be the same name as the formname used in SETUP. *ALL cannot be used because XML form relies on the successful execution of *.frm which happens after the execution of the SETUP file (*.nol).

For XML driven form, since both SETUP (*.nol) and LINK file (*.lnk) are stored only in FLASH, the users can delete the flash files through the front panel option. See the LINK command on page 74 for a description and example.

Example 1 (for XML form)

```
~SETUP;TESTXML
~DELETE LOGO;epc300.tif
~DELETE LOGO;PCXLOGO
~LOGO;PCXLOGO;PCX
<Raster Data>~RASTEREND
END
~SETUPEND

~CREATE;TESTXML;432;DISK
SCALE;DOT;100;100
LOGO
40;40;PCXLOGO
STOP
LOGO
40;292;epc300.tif
STOP
ALPHA
AF1;16;POINT;140;180;14;11
STOP
END

~LINK;TESTXML;DISK
~AF1;$BUSINESS_PARTNER$
~NORMAL
```

Special Function Control Code Change

Purpose	Changes the current Special Function Control Code (SFCC).
Mode	NORMAL or EXECUTE
Format	(cc)SFCC; <i>n</i> or (cc)SFCC; ' <i>n</i> ' (cc) SFCC; The current Special Function Control Code. SFCC; Specifies the Special Function Control Code change command. Enter SFCC ; (the semicolon is required.) <i>n</i> Represents the ASCII numeric value for the new SFCC. Replace <i>n</i> with an ASCII value from 0 through 255 . ' <i>n</i> ' Represents the hexadecimal value for a printable character as the new SFCC. Replace ' <i>n</i> ' with a hexadecimal value from 20 through 7F . If representing the new SFCC in hexadecimal, it must be enclosed in single quotes.

Comments

When the SFCC is changed using the SFCC command, the change is effective immediately and the old SFCC is no longer recognized.

When printer power is turned off and on, the SFCC returns to the configuration default. The configuration default SFCC can also be re-selected by sending the command: **(cc)SFCC; ' '**

Example

The following example, using both the ASCII and hexadecimal values, changes the SFCC from the tilde (~) to the caret (^).

```
~SFCC;94 or  
~SFCC;'5E'
```

TIFF Logo

Purpose	Places the IGP/PGL in the Create Logo mode, where logos can be defined using a Tagged Image File Format (TIFF).
Mode	NORMAL, CREATE
Format	(NORMAL) (cc)LOGO; <i>logoname</i> ;TIFF[;TRIM][;ROT][;DISK](T) <i>TIFF raster data</i> (cc)RASTEREND END
Format	(CREATE) LOGODEF; <i>logoname</i> ;TIFF[;TRIM][;ROT] (T) <i>TIFF raster data</i> (cc)RASTEREND STOP (cc) The Special Function Control Code. LOGO The Logo command; enter LOGO.

<i>logoname</i>	Enter a maximum of 15 alphanumeric characters for the name of the logo. (Refer to page 22 for a list of allowable Logo Name characters.) All future references to this logo (Delete Logo or Logo Call commands) must use this name. If a logo is defined with the same name as a logo already existing in memory, the newly defined logo will replace the existing logo.
TIFF	The command denoting raster data in TIFF format; enter TIFF .
TRIM	Optional parameter that removes extra white space bounding the image, which saves memory inside the printer. Also helps position the image in an IGP/PGL form. Enter TRIM .
ROT	Optional parameter for images scanned in orientations other than upright. Enter either CW (for 90 degrees clockwise rotation), CCW (for 90 degree counterclockwise rotation), or INV (for inverted characters; 180 degrees rotations.)
DISK	Optional parameter to store the logo to Onboard Flash Memory. Not allowed for logos defined in CREATE mode. When defining a logo in NORMAL mode, enter DISK to store the logo to Onboard Flash Memory, or enter EMC to store the logo in the SD card or Expanded Memory Cartridge. See Flash Memory Storage on page 18 for details.
(T)	A line terminator (i.e., LF, FF) must separate the LOGO line from the beginning of the TIFF raster data.

TIFF raster data

Scanned data in TIFF format; data must be black and white. Grey scales or color TIFF files are currently not supported. Both uncompressed and packed-bits compression formats are supported.

(cc)	The Special Function Control Code.
RASTEREND	Denotes the end of the TIFF raster data. Enter RASTEREND .
END	Terminates the TIFF logo; enter END .
STOP	Ends the Create Logo command while the IGP continues in the Create Form Mode. Enter STOP . If STOP is not entered, an error message results.

Comments

The size and number of raster image logos are bounded by printer memory. Also note that each rotation used requires a copy of the image; therefore, the number of rotations used affects the printer memory available.

The logo call command in the Create Form mode brings the predefined logo into a form. The starting row and column parameters refer to the upper left corner of the logo grid. Once created, the logo is ready to be used in any form and will print at the size shown.

Raster images may contain data that is interpreted by your host as control codes. This may affect the way the host sends data to the printer. Consult your host's *Administrator's Manual* for sending binary data.

Be careful when editing TIFF output files because most TEXT editors insert carriage returns and line feeds. If a TIFF file must be edited, use a binary or hex editor.

NOTE: Be careful sending TIFF data. The LOGO line must be terminated and then the TIFF data must follow immediately (with no extra CR/LF's). Otherwise, improper operation will result.

3 *Bar Codes*

Overview

A bar code is a graphic representation of alphanumeric characters. Bar codes are produced by entering bar code data in the Create Form Mode. The IGP bar codes are listed in Table 11, with detailed bar code information provided on the referenced pages. All parameters must be separated by a semicolon (;) unless noted otherwise. Throughout this chapter, actual commands required for input are shown exactly as they must be entered, while all parameters associated with that command are shown in italics. Optional parameters are enclosed in brackets. Spaces are used only to visually separate the command parameters, but *do not* enter these spaces in your command.

The single most important consideration when printing a bar code is to ensure the bar code will be scanned properly. Incorporating a bar code quality procedure in the printing process is the best way to ensure that bar codes are being printed correctly. A properly implemented validation procedure will increase overall bar code quality, reduce waste from misprinted bar codes, and achieve high first-time read rates, which is an increasingly important factor in newer, more efficient systems where manually entered data is not acceptable as a backup function. Validation also minimizes the costs of returned products due to poor reading or unaccountable bar codes. For more information on bar code validation, contact your Printronix representative or visit our web site at www.primtronix.com.

Table 11 Available Bar Codes

Bar Code	Mnemonic	Symbol Length	Code Set	Page No.
Australian 4-State	AUSTPOST	Variable	Alphanumeric	108
Codabar	CODABAR	Variable	Alphanumeric	113
Code 35	C35	Variable	Alphanumeric	118
Code 39	C3/9	Variable	Alphanumeric	120
Code 93	CODE93	Variable	Alphanumeric	126
Code 128 – A, B or C	C128A C128B C128C	Variable	Alphanumeric	131
EAN8	EAN8	7 digits	Numeric	141
EAN13	EAN13	12 digits	Numeric	146
FIM	FIM	n/a	A, B, C or D	152
German I-2/5	I25GERMAN	11 or 13 digits	Numeric	184
GS1-128, formerly UCC/EAN-128	UCC-128	Variable	Alphanumeric	158
GS1 Datamatrix, formerly Datamatrix	DATAMATRI X	Variable	Alphanumeric	170

Table 11 Available Bar Codes

Bar Code	Mnemonic	Symbol Length	Code Set	Page No.
Intelligent Mail 4-State	INTMAIL	20, 25, 29, or 31 digits	Alphanumeric	181
Interleaved 2/5	I-2/5	Variable	Numeric	184
ITF-14	ITF14	13 digits	Numeric	184
Matrix	MATRIX	Variable	Numeric	189
MSI	MSI	13 or 14 digits	Numeric	193
PDF417	PDF417	Variable	Alphanumeric	198
Planet	PLANET	11 digits	Numeric	206
Plessey	PLESSEY	Variable	Alphanumeric	211
POSTNET	POSTNET	5, 9, or 11 digits	Numeric	216
PostBar	POSTBAR	Variable	0-3	221
QR Code	QRCODE	Variable	Alphanumeric	224
Royal Mail	ROYALBAR	Variable	Alphanumeric	221
Telepen	TELEPEN	Variable	Alphanumeric	228
UPC-A	UPC-A	11 digits	Numeric	233
UPC-E and UPC-E0	UPC-E UPC-E0	11 or 6 digits	Numeric	238
UPCSHIP	UPCSHIP	13 digits	Numeric	245
UPS11	UPS11	10 digits	Alphanumeric	249

User-Defined Variable Bar Code Ratios

The user-defined variable ratio for bar codes is an optional parameter. The default ratios shown in Table 12 and Table 13 are overridden by the variable ratio feature. Four- and eight-digit ratios can be used, depending upon the bar code selected. Ratio data must be decimal values greater than 0. Enter **R**, followed by the actual bar code ratio. A colon must separate each element of the ratio.

Like standard bar code ratios, user-defined ratios are also interpreted from left to right, measuring the size of each bar or space, in dot width, in the following pattern: narrow bar : narrow space : wide bar : wide space. See Table 12 and Table 13 for the number of values needed. If the **D** parameter is specified, the ratios are represented in printer dots instead of IGP dots (60 x 72 dpi).

User-defined ratios can be disabled from the front panel menu. See your *Administrator's Guide* for details.

NOTE: The IGP does not verify that ratio data creates acceptable wide/narrow element relationships for bar code readability. When designing unique ratio data, carefully plot wide and narrow ratios to conform to readable bar codes.

User-Defined Variable Ratios for Postal Barcodes

The user-defined variable ratio can also be used for Postal barcodes including Postnet, Planet, Australian 4-State, PostBar, Royal Mail, and Intelligent Mail 4-State.

The user-defined ratio follows the same general syntax rules but with the following pattern: bar width: space width: short bar height: full bar height. The D parameter can also be used for printer dots.

User-defined ratios can be disabled from the control panel menu. Refer to the *Administrator's Manual* for details.

NOTE: The IGP does not verify that ratio data creates acceptable wide/narrow element relationships for barcode readability. When designing unique ratio data, carefully plot wide and narrow ratios to conform to readable barcodes.

Variable Ratio Sample

```
~CREATE;TEST (Enters Create Form mode)
SCALE;CHAR
ALPHA (Alpha command)
2;5;1;1;1;*Std. Ratio*
STOP (Ends Alpha command)
BARCODE (Bar code command)
C3/9;X1;H7;3;5
"CODE39"
PDF;B;N (Printable data field)
STOP (Ends bar code command)
/
/
/
/
ALPHA (Alpha command)
2;30;1;1;*Var. Ratio*
STOP (Ends bar code command)
BARCODE (Bar code command)
C3/9;XRD2:2:5:5;H7;3;30
"CODE39"
PDF;B;N (Printable data field)
STOP (Ends bar code command)
END (Terminates Create Form mode)
~EXECUTE;TEST;1 (Prints the form)
~NORMAL
```

Std. Ratio



CODE39

Var. Ratio



CODE39

PDF Character Sizes [PDF [;LOC] [;FONT]]

For UPC and EAN bar codes, a smaller Letter Gothic font will be substituted for OCR-A or OCR-B when the bar code symbol is not large enough to accommodate a 10 CPI font.

For all other bar codes, OCR-A and OCR-B will print at 10 CPI. However, when using the Normal font, the PDF will be automatically sized to fit the length of the bar code symbol, if necessary.

NOTE: Vertical bar codes print only in standard 10 cpi font because OCR fonts cannot be rotated. If an OCR-type font is selected with a vertical bar code command, the standard 10 cpi font is substituted automatically.

Bar Code Specifications

Table 12 IGP/PGL Bar Code Specification Summary for 12-Mil Tip Impact Printers

Description	Magnification Parameter	Average Narrow Element Width (mils)	Character Density (cpi)	Ratio	
Codabar	X1	16.7	5.4	4:3:2:1	
Code 39	X1	13.8	4.5	3:1	
	X1A	13.8	5.5	2:1	
	X1B	13.8	5.0	2.5:1	
	X2	31.0	2.3	2.3:1	
	X3	44.8	1.5	2.5:1	
	X4	58.6	1.2	2.4:1	
Code 128A	X1	13.8	6.5	4:3:2:1	
Code 128B	X1.5	20.7	5.0	4:3:2:1	
Code 93	X2	27.3	3.3	4:3:2:1	
UPS 11	X3	41.4	2.2	4:3:2:1	
	X4	55.2	1.7	4:3:2:1	
Code 128C	X1	13.8	13.2	4:3:2:1	
UCC/EAN-128	X1.5	20.7	9.9	4:3:2:1	
GS1-128, formerly	X2	27.3	6.5	4:3:2:1	
UCC/EAN-128	X3	41.4	4.4	4:3:2:1	
	X4	55.2	3.3	4:3:2:1	
EAN 8 and 13	default	13.8	1.05 MAG	4:3:2:1	
Interleaved 2/5	X1	13.8	8.1	3:1	
German I-2/5	X1A	17.2	7.1	2.6:1	
ITF-14	X1B	13.8	10.4	2:1	
	X2	31.0	4.2	2.3:1	
Matrix	X2A	27.6	5.2	2:1	
	X3	44.8	2.8	2.5:1	
	X4		58.6	2.2	2.4:1
MSI-A	X1	13.8	7.6	3:1	
MSI-B	X2	20.7	5.0	2.5:1	
MSI-C	X3	27.6	3.8	2.3:1	
MSI-D	X4	34.5	3.0	2.3:1	
Plessey					
UPC-A and E	default	13.8	1.05 MAG	4:3:2:1	
PostBar	X1	n/a	n/a	n/a	
Royal Mail Australian Post	X1A				

Table 12 IGP/PGL Bar Code Specification Summary for 12-Mil Tip Impact Printers

Description	Magnification Parameter	Average Narrow Element Width (mils)	Character Density (cpi)	Ratio
Planet POSTNET	Per U.S. Postal Service <i>Publication 25: A Guide to Business Mail Preparation</i> (USPS Certified)			

Table 13 PGL Bar Code Specification Summary for 16-Mil Tip Impact Printers

Description	Magnification Parameter	Average Narrow Element Width	Character Density (cpi)	Ratio
Codabar	X1	16.7	5.4	4:3:2:1
Code 39	X1	16.7	3.75	3:1
	X1A	16.7	4.6	2:1
	X1B	16.7	4.2	2.5:1
	X2	37.5	1.9	2.3:1
	X3	54.2	1.3	2.5:1
Code 128A Code 128B Code 93	X4	70.8	1.1	2.4:1
	X1	16.7	5.4	4:3:2:1
	X1.5	25.0	4.1	4:3:2:1
	X2	33.0	2.7	4:3:2:1
UPS 11	X3	50.0	1.8	4:3:2:1
	X4	66.7	1.4	4:3:2:1
Code 128C UCC/EAN-128	X1	16.7	10.9	4:3:2:1
	X1.5	25.0	8.2	4:3:2:1
	X2	33.0	5.4	4:3:2:1
	X3	50.0	3.6	4:3:2:1
EAN 8 and 13	X4	66.7	2.7	4:3:2:1
	default	16.7	1.28 MAG	4:3:2:1
Interleaved 2/5 German I-2/5 ITF-14	X1	16.7	6.7	3:1
	X1A	20.8	5.7	2.6:1
	X1B	16.7	8.5	2:1
	X2	37.5	3.5	2.3:1
Matrix	X2A	33.2	4.3	2:1
	X3	54.2	2.3	2.5:1
	X4	70.8	1.8	2.4:1
MSI-A MSI-B MSI-C MSI-D Plessey	X1	16.7	6.1	3:1
	X2	25.1	4.1	2.5:1
	X3	33.4	3.0	2.3:1
	X4	41.7	2.4	2.3:1
UPC-A and E	default	16.7	1.28 MAG	4:3:2:1
PostBar Royal Mail Australian Post	X1	n/a	n/a	n/a
	X1A	n/a	n/a	n/a
Planet POSTNET	Per U.S. Postal Service <i>Publication 25: A Guide to Business Mail Preparation</i> (USPS Certified)			

Bar Codes

The rest of this chapter describes each of the bar codes available with the IGP emulation.

Australian 4-State

The Australian 4-State structure is shown in Figure 7 and described on the following pages.

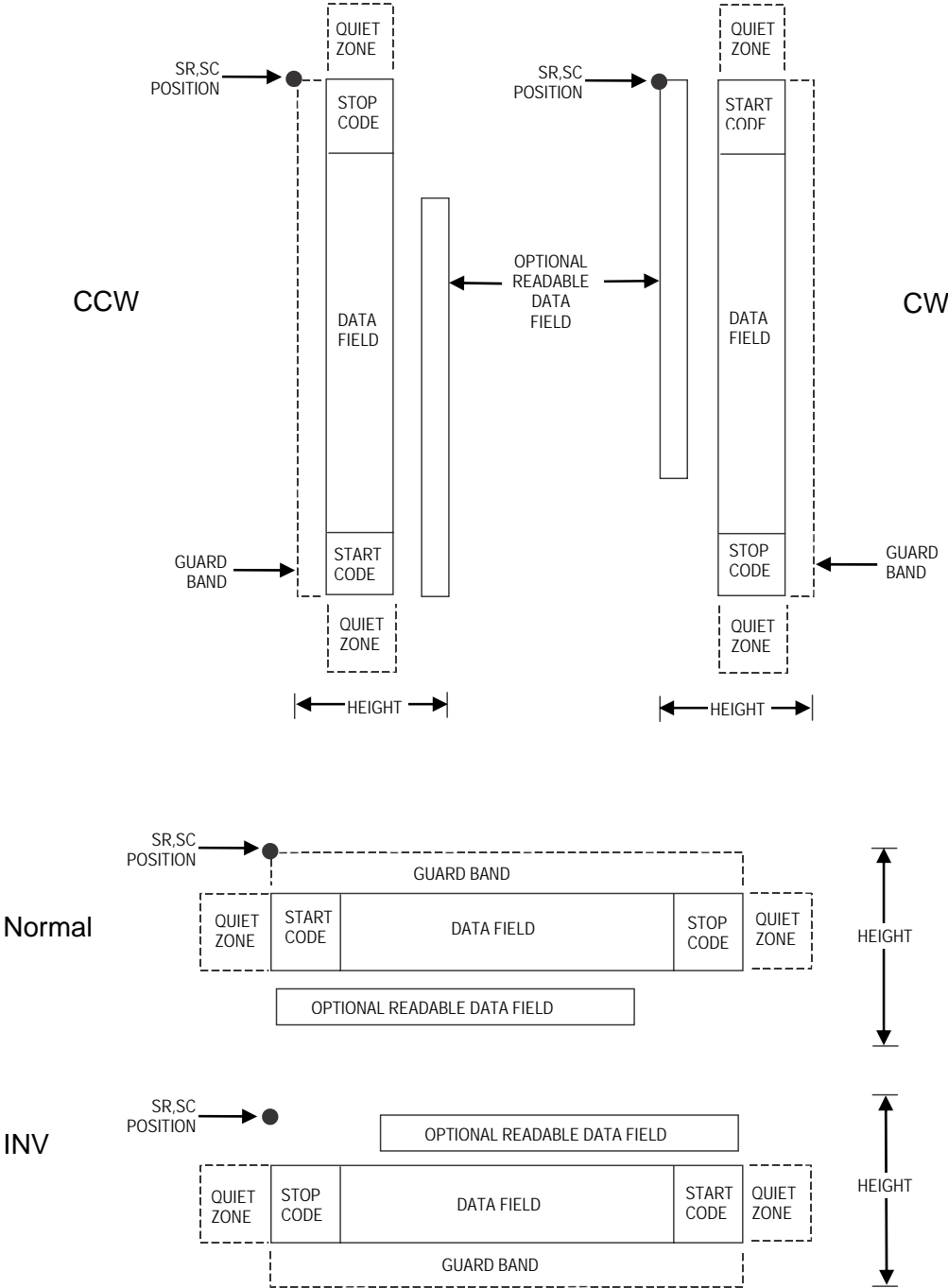

Figure 7 Australian 4-State Structure

The Australian 4-State bar code supports the Australian Postal Service. Australian 4-State bar codes are similar to POSTNET in terms of bar space and width, but have four different types of bars (Full Height, Ascender, Descender, and Tracker), whereas POSTNET only has two bar types (Tall and Short).

The Australian 4-State symbology converts alphanumeric characters into patterns of four bars, using combinations of Full Height, Ascender, Descender, and Trackers. It also adds start and stop bar codes as well as Reed-Solomon parity information.

Quiet Zone

Quiet zones extend on both ends of the bar code to permit the scan to begin and end in a blank area. The quiet zones should be at least 0.25 inches wide and completely blank to ensure accurate reading of the start/stop codes and to prevent adjacent bar codes from overlapping. You are responsible for providing sufficient space on the form for the quiet zones.

Start/Stop Code

The start and stop bars identify the orientation of the bar code. The start bar consists of an ascender bar, and is positioned at the left-most end of the bar code. The stop bar consists of a full height bar, and is positioned at the right-most end of the bar code adjacent to the check digit.

Data Field

Australian 4-State bar codes use four types of bars to encode its data: Full Height, Ascender, Descender, and Tracker. Each Full Height bar is 0.198 inch \pm 0.030 inch. The Ascender and Descender bars are about 62.5% of the Full Height bar in length, while the Tracker bar is about 25% of the Full Height bar.

Each bar *width* is equal, and must be .020-inch \pm .005-inch. Horizontal spacing between bars (pitch) must be 22 bars \pm 2 bars per inch over any 0.50-inch portion of the bar code.

The Australian 4-State bar code data field consists of four different sections: the FCC, Sorting Number, Customer Data, and Reed-Solomon parity information. The FCC is a two-digit code specifying the format of the barcode (see Table 14). The Sorting Number is an 8-digit code used to sort the mail item. Customer Data is optional and is only allowed on certain formats (as indicated by the FCC selected). The IGP emulation automatically generates the Reed-Solomon parity information and includes it in the barcode.

Check Digit

No check digit is calculated for the Australian 4-State bar code. The Reed- Solomon parity information is automatically included.

Australian 4-State Command Format

BARCODE

AUSTPOST;[FCC*n*];[INFO*n*];[DIR];[NLQ];[MAG];[BF*n*;L];[DARK];SR;SC (D) [data field] (D)[PDF [;LOC [;FONT]]

STOP

BARCODE The Bar Code command; enter **BARCODE**.

AUSTPOST Designates bar code type Australian 4-State; enter **AUSTPOST**.

FCC*n* Specifies the FCC code, which defines the format of the barcode and its size. If no value is specified, the FCC defaults to a value of 11. Enter **FCC**, then one of the values shown in Table 14.

INFO*n* Specifies the format of the customer information field. If no value is specified, the information field defaults to a value of 1. Enter **INFO**, then one of the values shown in Table 14.

Table 14 FCC Codes, Customer Information Fields and Maximum Bar Code Lengths

FCC (FCCn)	Customer Information (INFOn)	Valid Data	Maximum Length (Sorting Number + Customer Data)
11, 87, 45, or 92	n/a	Any	8 + 0
59	1	A-Z, a-z, 0-9, space, #	8 + 5
59	2	0-9	8 + 7
59	3	0-3	8 + 15
44, 62	1	A-Z, a-z, 0-9, space, #	8 + 10
44, 62	2	0-9	8 + 15
44, 62	3	0-3	8 + 30

NOTE: For an **INFO n** value of 3, the digits 0 through 3 represent the following bars: 0 = Full Height; 1 = Ascender; 2 = Descender; 3 = Tracker. Since this is a proprietary encoding, the Customer Data is not included in the optional readable data field.

DIR Optional parameter to orient the bar code structure vertically. Enter **CW** for clockwise rotation. Enter **CCW** or **VSCAN** for counter-clockwise rotation. Enter **INV** for inverted rotation. If **DIR** is not entered, the barcode is horizontally oriented.

NLQ Optional parameter optimized to print barcodes at NLQ print density (180x96). This may cause line matrix printers to reverse motion when the form prints. This parameter is ignored for other printer types.

MAG Optional parameter to magnify (horizontally expand) the bar code symbol. The magnification default value is **X1**. As required for scanning, enter a magnification value from Table 12, page 106 or Table 13, page 107, depending on your printers tip size to increase the magnification. Increasing the magnification adjusts printed character density.

NOTE: The User-Defined variable ratio is not allowed for this barcode.

BF n ;L Optional parameters for assigning a dynamic bar code data field location on a form and for designating the length of the data field. With these parameters, the actual data for the bar code data field is dynamically provided during the Execute Form Mode; the data is not specified during the Create Form Mode. To use this field, perform the following steps:

- a. Enter **BF**.
- b. Replace n with a number ranging from **0 through 512** to identify the bar code field. The **SR** and **SC** parameters specify the exact location of the bar code field identified by n .
- c. Replace L with a number equaling the total number of characters in the field. (The actual data provided dynamically during the Execute Form Mode can be less than L .)
- d. The information for the data field is entered dynamically during the Execute Form Mode. (Refer to Execute Form: Dynamic Bar Code Data on page 62.) Do not use the *data field* parameter to enter data

when the *BFn;L* parameters are used. However, refer to the *data field* description for available characters.

DARK	Optional parameter to produce darker looking bar codes. Enter DARK . Refer to Dark Printing on page 52 for more information.
SR	Defines the starting row for the bar code. Enter a value ranging from row 1 to one less than the length of the form. Character row or dot row is specified based on the Scale command (page 95), or use the CP.DP format (page 24).
SC	Defines the starting column of the bar code. Enter a value ranging from column 1 to one less than the width of the form. Character column or dot column is specified based on the Scale command (page 95), or use the CP.DP format (page 24).
(D)	The printable character (delimiter) identifying the start and finish of the data field. Enter any printable character other than a slash (/), the SFCC, or a character used within the data. The same character must be used at both ends of the data field, but it is not printed with the data.
<i>data field</i>	Contains the bar code characters. See Data Field on page 109 for a description of the Australian 4- State bar code data field.
PDF	Optional parameter to enable printing of the human readable data field. Enter PDF to print the data field. If the parameter is not used, the human readable data will not print. This parameter is not allowed if a null data field is specified.
LOC	Optional parameter to identify the location of the printable data field. The default value is B , locating the human readable data below the bar code. A locates the printable data field above bar code. To compensate for printing the 0.1-inch high data, the height of the bar code body is reduced 0.1 inch.
FONT	Optional parameter to select the font for the human readable data field. Enter O to select OCR-A font; enter X to select OCR-B font; enter N to select 10 cpi; enter P to select 12 cpi; enter Q to select 13 cpi; enter R to select 15 cpi; enter T to select 17 cpi; enter V to select 20 cpi. To select a scalable font with user-defined size, enter Nh:w or F;Nh:w . The parameters h (height) and w (width) can each range from 1 to 96, and are expansion factors of a 10 cpi character. Nh:w prints in Letter Gothic (font 93779) regardless of the current active font. By default F;Nh:w uses the Letter Gothic as the current font selection. You can change the default by using the FONT command.

NOTE: Nh:w and F;Nh:w will not print the PDF wider or taller than the barcode. If the height parameter h causes the PDF to print above the horizontal barcode start row or vertical barcode start column, a barcode font Error will occur. If the width parameter w causes the PDF to exceed the barcode width, the PDF width factor w will automatically reduce to fit within the barcode width without causing an error.

STOP	Ends the Bar Code command while the IGP continues in the Create Form Mode. Enter STOP . If STOP is not entered, an error message results.
------	--

Australian 4-State Example

```
~CREATE;TEST (Enter Create Form mode)
BARCODE (Bar code command)
AUSTPOST;FCC62;INFO1;9;8 (Australian 4-State bar code, FCC=62,
                           INFO=1, SR 9, SC 8)
*00141544adc0gre117* (Data Field; 8-digit Sorting Number +
                     10 alphanumeric customer data)
PDF;A (Printable data field above bar code)
STOP (Ends bar code command)
BARCODE (Bar code command)
AUSTPOST;VSCAN;9;50 (Vertical Australian 4-State bar code,
                    FCC=11, INFO=1, SR 9, SC 50)
*00540171* (Data Field; 8-digit Sorting Number)
PDF (Printable data field)
STOP (Ends bar code command)
END (Terminates Create Form mode)
~EXECUTE;TEST;1 (Execute the form, form count of 1)
~NORMAL
```



Codabar

The Codabar structure is shown in Figure 8 and described on the following pages.

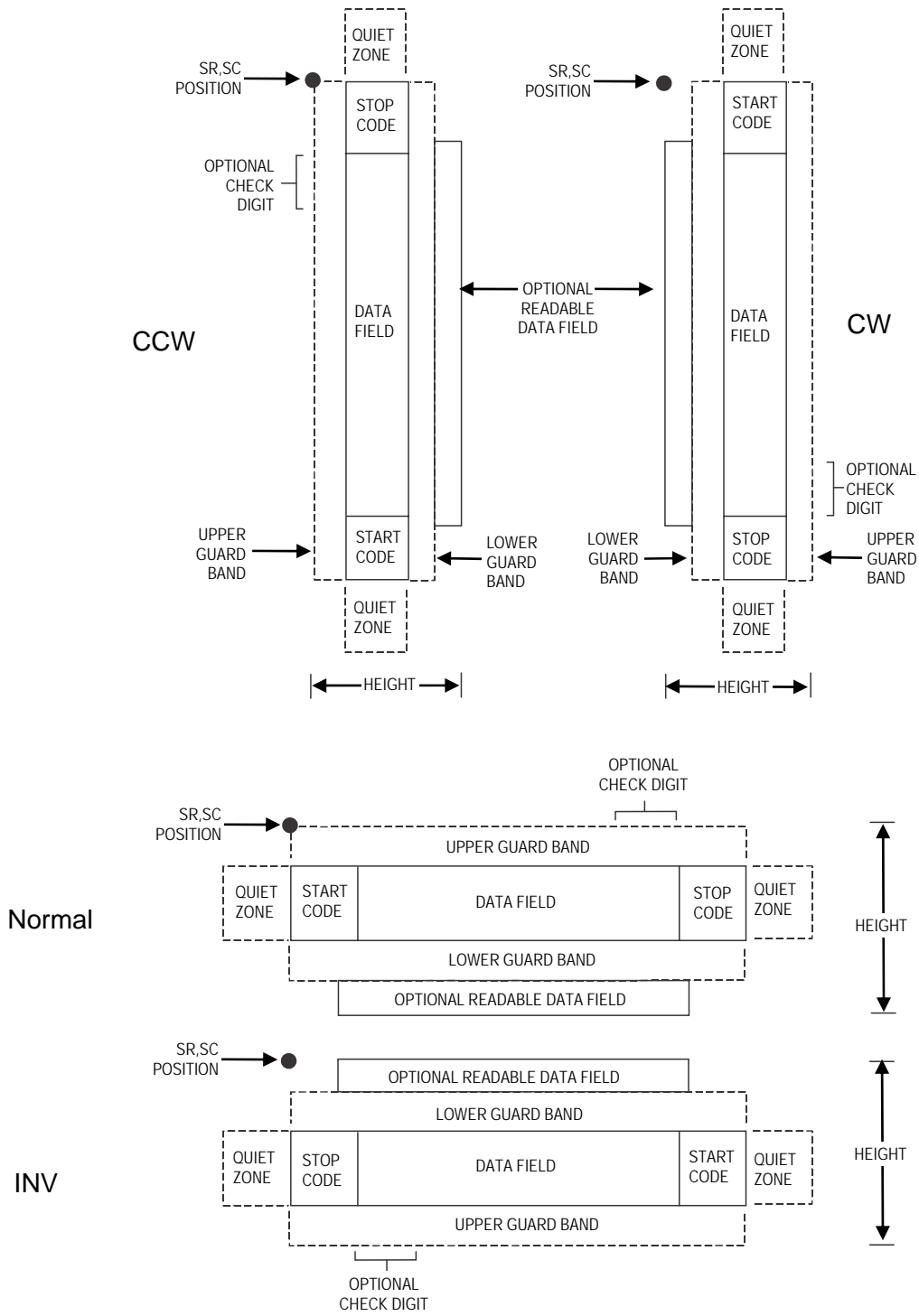

Figure 8 Codabar Structure

Quiet Zone

Both ends of the bar code structure require blank quiet zones. The quiet zones must be at least 0.25 inches wide and completely blank to ensure accurate reading of the start/stop codes and to prevent adjacent bar codes from overlapping. Be sure to provide sufficient space on the form for the quiet zones.

Start/Stop Codes

The start/stop code is a unique character identifying the leading and trailing end of the bar code. The start/stop code is automatically produced with each bar code. The start/stop code structure permits bidirectional bar code scanning.

Data Field

The bar code symbol uses a series of wide and narrow bars and spaces to represent standard alphanumeric characters. Each wide or narrow bar or space is one element; each character in the data field has nine elements. The structure is three wide elements (bars or spaces) out of the nine total elements which compose one character.

Readable Data

The optional readable data field provides a readable interpretation of the bar code data. It can be printed above or below the bar code symbol.

Check Digit

The optional modulo-43 check digit can be inserted into the bar code to verify accurate scanning.

Codabar Command Format

BARCODE
CODABAR [CD];[DIR;] [MAG;] [Hn[.m];] [BFn;L;] [DARK;] SR;SC
(D) [data field] (D)
[PDF [;LOC] [;FONT]]
STOP

BARCODE	The Bar Code command; enter BARCODE .
CODABAR CD	Designates bar code type Codabar; enter CODABAR . To calculate and plot the optional modulo-43 check digit with the bar code symbol automatically, enter CD .
DIR	Optional parameter to orient the bar code structure vertically. Enter CW for clockwise rotation. Enter CCW or VSCAN for counter-clockwise rotation. Enter INV for inverted rotation. If <i>DIR</i> is not entered, the barcode is horizontally oriented.
MAG	Optional parameter to magnify (horizontally expand) the bar code symbol. The magnification default value is X1 . As required for scanning, enter a magnification value from Table 12, page 106 or Table 13, page 107, depending on your printers tip size to increase the magnification. Increasing the magnification adjusts printed character density. You can also use XR or XRD as defined on page 104.

NOTE: You must specify four digits for MAG for User Defined variable ratio. There are four values that comprise the dot ratio: narrow bar, narrow space, wide bar, and wide space. User-defined ratios for this barcode should have these four values defined in the order specified.

Hn[.m]	Optional parameter to adjust the overall height (vertical expansion) of the bar code symbol (including the upper and lower 0.1-inch guard bands and any human readable data). Height adjustments are made in 0.1-inch increments; enter H and a value from 3 through 99 to select height adjustments from 0.3 through 9.9 inches. The default value is 0.9 inch.
--------	---

[.m] is an additional number of dots for the bar code height. (Dots are in the current dot scale.)

NOTE: If 0.3 inches is the selected height, the PDF cannot be included.

<i>BFn;L</i>	Optional parameters for assigning a dynamic bar code data field location on a form and for designating the length of the data field. With these parameters, the actual data for the bar code data field is dynamically provided during the Execute Form Mode; the data is not specified during the Create Form Mode. To use this field, perform the following steps: <ol style="list-style-type: none">Enter BF.Replace <i>n</i> with a number ranging from 0 through 512 to identify the bar code field. The <i>SR</i> and <i>SC</i> parameters specify the exact location of the bar code field identified by <i>n</i>.Replace <i>L</i> with a number equaling the total number of characters in the field. (The actual data provided dynamically during the Execute Form Mode can be less than <i>L</i>.)The information for the data field is entered dynamically during the Execute Form Mode. (Refer to Execute Form: Dynamic Bar Code Data on page 62.) Do not use the <i>data field</i> parameter to enter data when the <i>BFn;L</i> parameters are used. However, refer to the <i>data field</i> description for available characters.
DARK	Optional parameter to produce darker looking bar codes. Enter DARK . Refer to Dark Printing on page 52 for more information.
<i>SR</i>	Defines the starting row for the bar code. Enter a value ranging from row 1 to one less than the length of the form. Character row or dot row is specified based on the Scale command (page 95), or use the CP.DP format (page 24).
<i>SC</i>	Defines the starting column of the bar code. Enter a value ranging from column 1 to one less than the width of the form. Character column or dot column is specified based on the Scale command (page 95), or use the CP.DP format (page 24).
<i>(D)</i>	The printable character (delimiter) identifying the start and finish of the data field. Enter any printable character other than a slash (/), the SFCC, or a character used within the data. The same character must be used at both ends of the data field, but it is not printed with the data.
<i>data field</i>	Contains the bar code characters. A null data field (no characters) is permitted. The data field can contain any of the characters listed in Table 15 except the SFCC, and the first character and the last character in the data field must be either A , B , C , or D . The length of the data field is variable; however, the maximum length is usually limited to 32 characters to minimize potential reading errors.
PDF	Optional parameter to enable printing of the human readable data field. Enter PDF to print the data field. If the parameter is not used, the human readable data will not print. This parameter is not allowed if a null data field is specified.
<i>LOC</i>	Optional parameter to identify the location of the printable data field. The default value is B , locating the human readable data below the bar code. A locates the printable data field above bar code. To compensate for printing the 0.1-inch high data, the height of the bar code body is reduced 0.1 inch.

FONT

Optional parameter to select the font for the human readable data field. Enter **O** to select OCR-A font; enter **X** to select OCR-B font; enter **N** to select 10 cpi; enter **P** to select 12 cpi; enter **Q** to select 13 cpi; enter **R** to select 15 cpi; enter **T** to select 17 cpi; enter **V** to select 20 cpi.

To select a scalable font with user-defined size, enter **Nh:w** or **F;Nh:w**. The parameters h (height) and w (width) can each range from 1 to 96, and are expansion factors of a 10 cpi character. Nh:w prints in Letter Gothic (font 93779) regardless of the current active font. By default F;Nh:w uses the Letter Gothic as the current font selection. You can change the default by using the FONT command.

NOTE: Nh:w and F;Nh:w will not print the PDF wider or taller than the barcode. If the height parameter h causes the PDF to print above the horizontal barcode start row or vertical barcode start column, a barcode font Error will occur. If the width parameter w causes the PDF to exceed the barcode width, the PDF width factor w will automatically reduce to fit within the barcode width without causing an error.

STOP

Ends the Bar Code command while the IGP continues in the Create Form Mode. Enter **STOP**. If STOP is not entered, an error message results.

Table 15 Codabar Character Set

Character	Hex	Character	Hex
0	30	-	2D
1	31	\$	24
2	32	:	3A
3	33	/	2F
4	34	.	2E
5	35	+	2B
6	36	A	41
7	37	B	42
8	38	C	43
9	39	D	44

Codabar Example

~CREATE;TEST;288	(Enter Create Form mode)
BARCODE	(Bar code command)
CODABAR;VSCAN;X1;H7;5;20	(Vertical Codabar bar code, MAG 1, SR 5, SC 20)
A12345B	(Data Field)
PDF;B;N	(Printable data field)
STOP	(Ends bar code command)
END	(Terminates Create Form mode)
~EXECUTE;TEST	
~NORMAL	

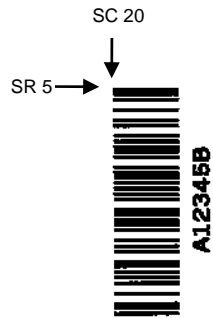

Code 35

The Code35 barcode is used in high speed processing and postal automation. The bar structure to be composed is simple and the safety of the barcode is excellent. Print speed is fast, so it is suitable for high speed reader of optical character. Each number in the data field contains the bar that indicates the start, so self-search is possible. The barcode is good for the error check.

Command Format

BARCODE

C35; [DIR;] [MAG;] [Hn;.m;] [BFn;L;] [DARK;] SR; SC

[(D)Data Field(D)]

STOP

Start Code

Each number in the data field contains the bar that indicate the start.

Data Field

Code 35 can accommodate 10 characters, 0 - 9. The following table lists the character with it's module sequence. Each character is composed of 6 bars of same kind which include 2 empty bars (bars removed from their place) and one start bar. Data Field is written form left to right, but barcode symbol is composed in an order of left to right which starts with the rightmost character in the data field to the leftmost character.

I = Bar

E = Empty Bar

S = Start Bar

- = Space

Character	Module Sequence
0	I-I-I-E-E-S-
1	E-E-I-I-I-S-
2	E-I-E-I-I-S-
3	I-E-E-I-I-S-
4	E-I-I-E-I-S-
5	I-E-I-E-I-S-
6	I-I-E-E-I-S-
7	E-I-I-I-E-S-
8	I-E-I-I-E-S-
9	I-I-E-I-E-S-

Check Code

The Code 35 has a mod 10 check character. The check character is automatically calculated and inserted in the end of barcode symbol. The check character verifies accurate scanning. The start bar is included in the check character.

GuardBand

Normally, there are guardbands 0.10 inches both above and below the bars of the barcode.

Magnification

There is only one pre-defined magnification for Code 35, X1, which is the default magnification.

NOTE: The User Defined variable ratio is not allowed for this barcode.

Height

The barcode can range from 0.3 - 9.9 inches tall. Default is 0.3 inches.

PDF

PDF is not included for Code 35.

C35 Example

```
~CREATE;TEST  
BARCODE  
C35;X1;H4;10;10  
*137130*  
STOP  
END  
~EXECUTE;TEST;1
```



Code 39

The Code 39 structure is shown in Figure 9 and described on the following pages.

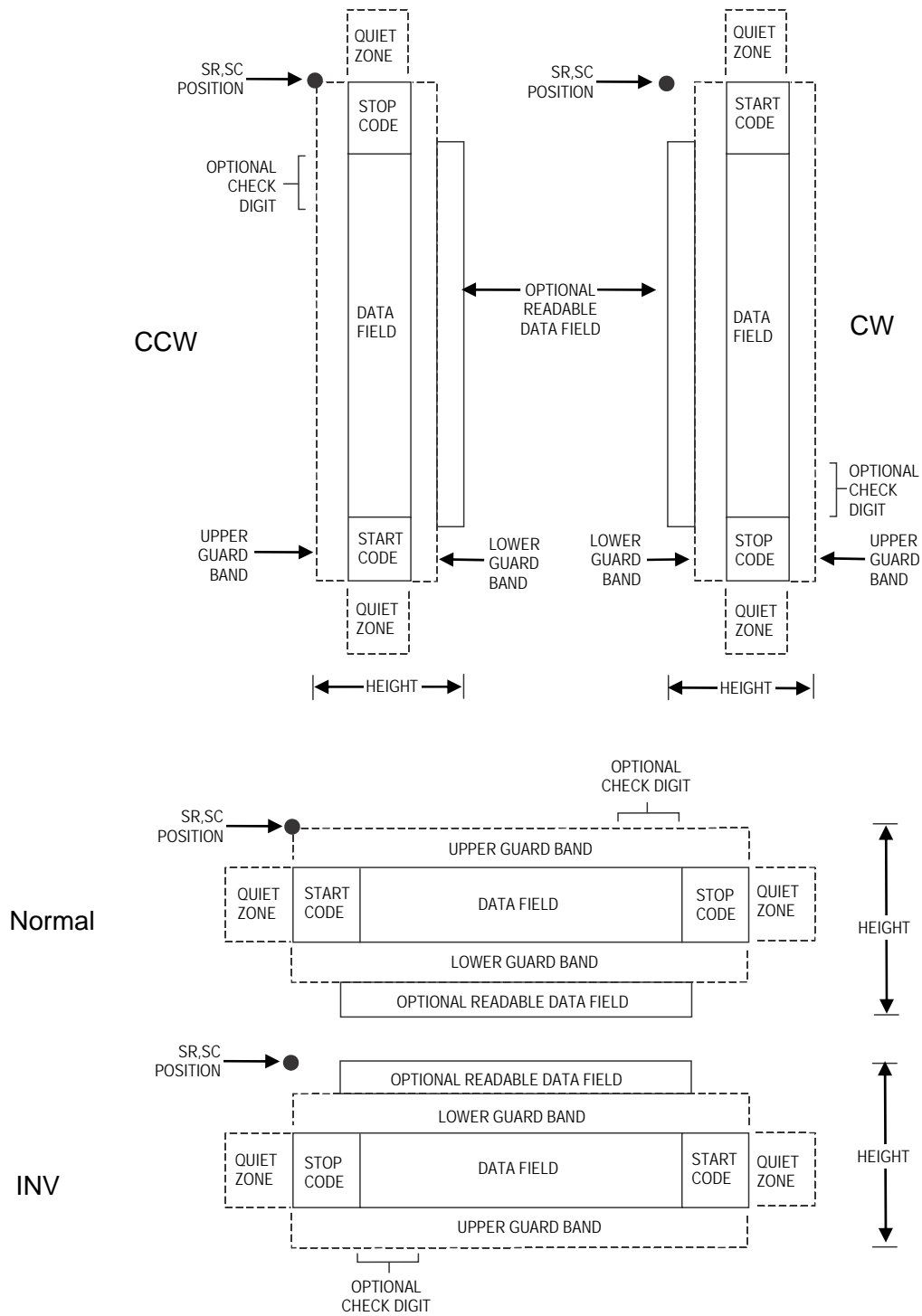

Figure 9 Code 39 Structure

Quiet Zone

Both ends of the bar code structure require blank quiet zones. The quiet zones must be at least 0.25 inches wide and completely blank to ensure accurate reading of the start/stop codes and to prevent adjacent bar codes from overlapping. Be sure to provide sufficient space on the form for the quiet zones.

Start/Stop Codes

The start/stop code is a unique character identifying the leading and trailing end of the bar code. The start/stop code is automatically produced with each bar code. The start/stop code structure permits bidirectional bar code scanning.

Data Field

The bar code symbol uses a series of wide and narrow bars and spaces to represent standard alphanumeric characters. Each wide or narrow bar or space is one element; each character in the data field has nine elements. The structure is three wide elements (bars or spaces) out of the nine total elements which compose one character.

For HIBC barcode, the data field is a variable length field consisting of only the following characters: 1-9, A-Z, -, ., \$, /, +, %, and space.

Readable Data

The optional readable data field provides a readable interpretation of the bar code data. It can be printed above or below the bar code symbol.

Check Digit

The optional modulo-43 check digit can be inserted into the bar code to verify accurate scanning.

For HIBC barcode, a mandatory modulo-43 checkdigit is inserted at the end of the data.

PDF

Unless requested, the PDF is not included. If included, it is separated from the bars by a guardband. The default font type used for PDF is N. Non-printable characters are printed as spaces. The check digit is included in the PDF.

For HIBC barcode, PDF is preceded with '+', a Flag Character which is an identifier used to differentiate HIBC symbols from other non-healthcare related barcode symbols. A pair of asterisks (*) encloses the human readable field, including the check digit.

Code 39 Command Format

NOTE: Although commonly referred to as Code "39", you must enter the command as "C3/9" (including the slash) during IGP input.

BARCODE

C3/9 [CD]; [**HIBC**;] [DIR;] [MAG;] [Hn[.m];] [BFn;L;] [DARK;]SR;SC

[(D) [data field] (D)][PDF [;LOC] [;FONT]]

STOP

BARCODE	The Bar Code command; enter BARCODE .
C3/9 CD	Designates bar code type C39; enter C3/9 . To calculate and plot the optional modulo-43 check digit with the bar code symbol automatically, enter CD .
<i>HIBC</i>	The Health Industry Bar Code (HIBC) is encoded in either Code 128 or Code 39 symbology. Enter HIBC . In a global setting, HIBC identifies health industry products, in any quantity, of any lot or serial number, with any expiration date. HIBC represents two kinds of information: Primary and Secondary Identification. Primary Identification represents product

identity and Secondary Identification represents the attributes of Lot or Batch Code, Serial Number, and Expiration date.

When encoding HIBC barcode in UCC-128, HIBC is essentially a UCC-128 barcode. The encoding uses the same module 10 check digit and data format. The only addition is an Application Identifier (AI) parameter. For Primary Data Structure use AI (01), and for Secondary Data Structure use AI (22) or AI (240). To use UCC-128 to encode HIBC, be sure to use the correct AI parameter to obtain the desired results.

DIR Optional parameter that allows for rotating a barcode. Enter **CW** for clockwise rotation. Enter **CCW** or **VSCAN** for counter-clockwise rotation. Enter **INV** for inverted rotation. If **DIR** is not entered, the barcode is horizontally oriented.

MAG Optional parameter to magnify (horizontally expand) the bar code symbol. The magnification default value is **X1**. As required for scanning, enter a magnification value from Table 12, page 106 or Table 13, page 107, depending on your printers tip size to increase the magnification. Increasing the magnification adjusts printed character density. You can also use XR or XRD as defined on page 104.

NOTE: You must specify four digits for MAG for User Defined variable ratio. There are four values that comprise the dot ratio: narrow bar, narrow space, wide bar, and wide space. User-defined ratios for this barcode should have these four values defined in the order specified.

Hn[.m] Optional parameter to adjust the overall height (vertical expansion) of the bar code symbol (including the upper and lower 0.1-inch guard bands and any human readable data). Height adjustments are made in 0.1-inch increments plus dots; enter **H** and a value from **3** through **99** to select height adjustments from 0.3 through 9.9 inches. The default value is 0.9 inch. [.m] is an additional number of dots for the bar code height. (Dots are in the current dot scale.)

NOTE: If 0.3 inches is the selected height, the PDF cannot be included.

BFn;L Optional parameters for assigning a dynamic bar code data field location on a form and for designating the length of the data field. With these parameters, the actual data for the bar code data field is dynamically provided during the Execute Form Mode; the data is not specified during the Create Form Mode. To use this field, perform the following steps:

- a. Enter **BF**.
- b. Replace *n* with a number ranging from **0** through **512** to identify the bar code field. The *SR* and *SC* parameters specify the exact location of the bar code field identified by *n*.
- c. Replace *L* with a number equaling the total number of characters in the field. (The actual data provided dynamically during the Execute Form Mode can be less than *L*.)
- d. The information for the data field is entered dynamically during the Execute Form Mode. (Refer to Execute Form: Dynamic Bar Code Data on page 62.) Do not use the *data field* parameter to enter data when the *BFn;L* parameters are used. However, refer to the *data field* description for available characters.

DARK Optional parameter to produce darker looking bar codes. Enter **DARK**. Refer to Dark Printing on page 52 for more information.

<i>SR</i>	Defines the starting row for the bar code. Enter a value ranging from row 1 to one less than the length of the form. Character row or dot row is specified based on the Scale command (page 95), or use the CP.DP format (page 24).
<i>SC</i>	Defines the starting column of the bar code. Enter a value ranging from column 1 to one less than the width of the form. Character column or dot column is specified based on the Scale command (page 95), or use the CP.DP format (page 24).
<i>(D)</i>	The printable character (delimiter) identifying the start and finish of the data field. Enter any printable character other than a slash (/), the SFCC, or a character used within the data. The same character must be used at both ends of the data field, but it is not printed with the data.
<i>data field</i>	Contains the bar code characters. A null data field (no characters) is permitted. The data field can contain any of the characters listed in Table 16 except the SFCC. The length of the data field is variable; however, the maximum length is usually limited to 32 characters to minimize potential reading errors.
<i>PDF</i>	Optional parameter to enable printing of the human readable data field. Enter PDF to print the data field. If the parameter is not used, the human readable data will not print. This parameter is not allowed if a null data field is specified.
<i>LOC</i>	Optional parameter to identify the location of the printable data field. The default value is B , locating the human readable data below the bar code. A locates the printable data field above bar code. To compensate for printing the 0.1-inch high data, the height of the bar code body is reduced 0.1 inch.
<i>FONT</i>	Optional parameter to select the font for the human readable data field. Enter O to select OCR-A font; enter X to select OCR-B font; enter N to select 10 cpi; enter P to select 12 cpi; enter Q to select 13 cpi; enter R to select 15 cpi; enter T to select 17 cpi; enter V to select 20 cpi. To select a scalable font with user-defined size, enter Nh:w or F;Nh:w . The parameters h (height) and w (width) can each range from 1 to 96, and are expansion factors of a 10 cpi character. Nh:w prints in Letter Gothic (font 93779) regardless of the current active font. By default F;Nh:w uses the Letter Gothic as the current font selection. You can change the default by using the FONT command.

NOTE: Nh:w and F;Nh:w will not print the PDF wider or taller than the barcode. If the height parameter h causes the PDF to print above the horizontal barcode start row or vertical barcode start column, a barcode font Error will occur. If the width parameter w causes the PDF to exceed the barcode width, the PDF width factor w will automatically reduce to fit within the barcode width without causing an error.

<i>STOP</i>	Ends the Bar Code command while the IGP continues in the Create Form Mode. Enter STOP . If STOP is not entered, an error message results.
-------------	--

Table 16 Code 39 Character Set

ASCII	CODE 39	ASCII	CODE 39	ASCII	CODE 39	ASCII	CODE 39
NUL	%U	SP	Space	@	%V	`	%W
SOH	\$A	!	/A	A	A	a	+A
STX	\$B	"	/B	B	B	b	+B
ETX	\$C	#	/C	C	C	c	+C
EOT	\$D	\$	/D	D	D	d	+D
ENQ	\$E	%	/E	E	E	e	+E
ACK	\$F	&	/F	F	F	f	+F
BEL	\$G	'	/G	G	G	g	+G
BS	\$H	(/H	H	H	h	+H
HT	\$I)	/I	I	I	i	+I
LF	\$J	*	/J	J	J	j	+J
VT	\$K	+	/K	K	K	k	+K
FF	\$L	,	/L	L	L	l	+L
CR	\$M	—	—	M	M	m	+M
SO	\$N	.	.	N	N	n	+N
SI	\$O	/	/O	O	O	o	+O
DLE	\$P	0	0	P	P	p	+P
DC1	\$Q	1	1	Q	Q	q	+Q
DC2	\$R	2	2	R	R	r	+R
DC3	\$S	3	3	S	S	s	+S
DC4	\$T	4	4	T	T	t	+T
NAK	\$U	5	5	U	U	u	+U
SYN	\$V	6	6	V	V	v	+V
ETB	\$W	7	7	W	W	w	+W
CAN	\$X	8	8	X	X	x	+X
EM	\$Y	9	9	Y	Y	y	+Y
SUB	\$Z	:	/Z	Z	Z	z	+Z
ESC	%A	;	%F	[%K	{	%P
FS	%B	<	%G	\	%L		%Q
GS	%C	=	%H]	%M	}	%R
RS	%D	>	%I	^	%N	~	%S
US	%E	?	%J	—	%O	DEL	%T %X %Y %Z

NOTE: Character pairs /M, /N, and /P through /Y are reserved for future control character pairs.

Code 39 Example

Figure 10 illustrates a horizontal and vertical Code 39 bar code generated by the following program:

```
~CREATE;C39          (Enter Create Form Mode)
BARCODE             (Bar Code Command)
C3/9;DARK;40;15     (Dark Code 39 at SR 40, SC 15)
*SAMPLE C3/9*       (Data Field)
PDF                 (Printable Data Field)
STOP                (Ends Bar Code Command)
BARCODE             (New Bar Code Command)
C3/9;VSCAN;H14;DARK;27;58 (Vert Dark Code 39, H 1.4, at SR 27, SC 58)
*SAMPLE C3/9*       (Data Field)
PDF                 (Printable Data Field)
STOP                (Ends Bar Code Command)
END                 (Terminates Create Form Mode)
~EXECUTE;C39;1      (Execute the form, form count of 1)
~NORMAL
```

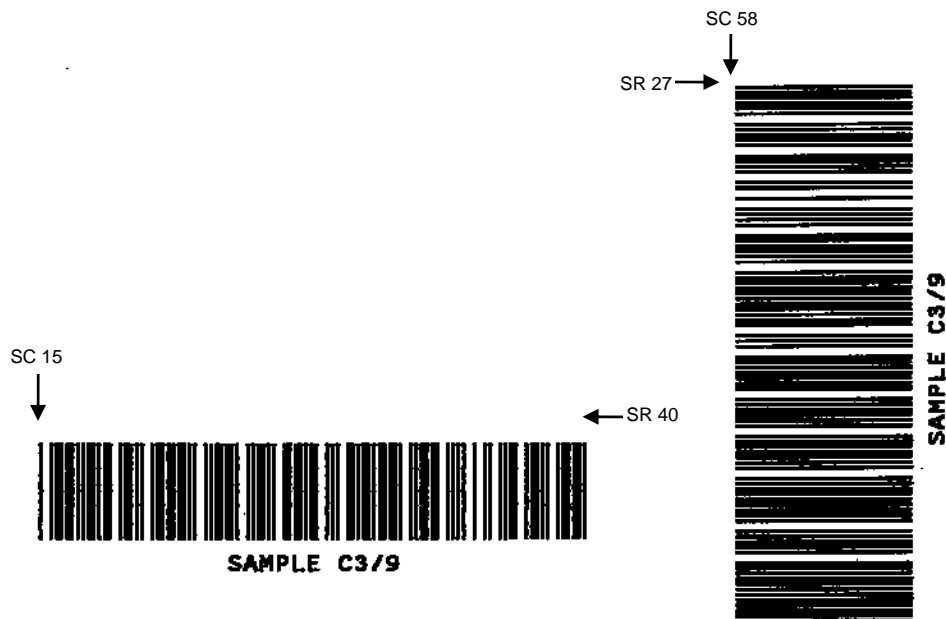

Figure 10 Sample code 39 Bar Codes

Code 93

The Code 93 structure is shown in Figure 11 and described on the following pages.

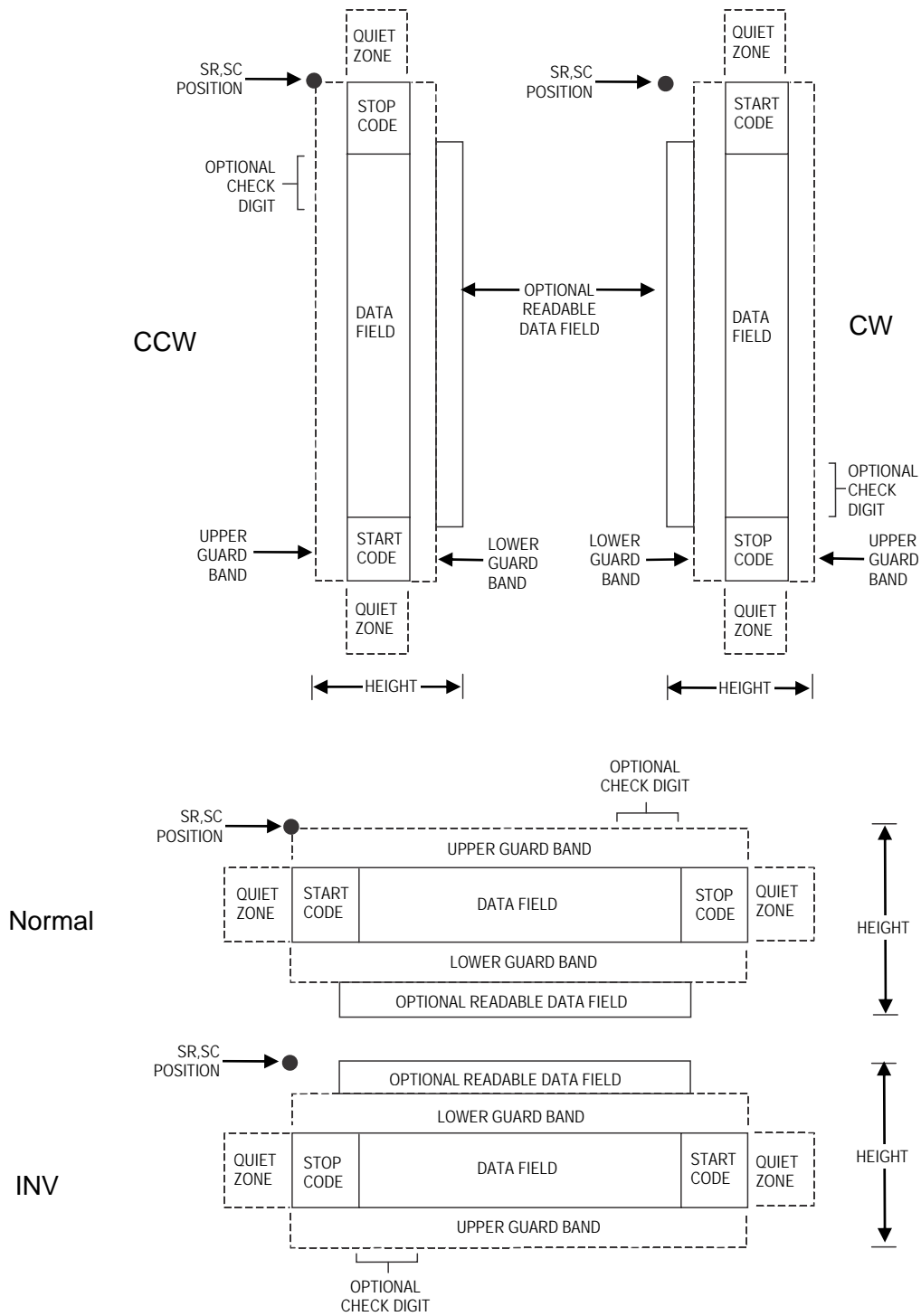

Figure 11 Code 93 Structure

Quiet Zone

Both ends of the bar code structure require blank quiet zones. The quiet zones must be at least 0.25 inches wide and completely blank to ensure accurate reading of the start/stop codes and to prevent adjacent bar codes from overlapping. Be sure to provide sufficient space on the form for the quiet zones.

Start/Stop Codes

The start/stop code is a unique character identifying the leading and trailing end of the bar code. The start/stop code is automatically produced with each bar code. The start/stop code structure permits bidirectional bar code scanning.

Data Field

The bar code symbol uses a series of varying width bars and spaces to represent an extensive character set. The bars and spaces vary in width from one through four modules. Each character consists of three bars and three spaces that total 11 modules.

Readable Data

The optional readable data field provides a readable interpretation of the bar code data. It can be printed above or below the bar code symbol.

Check Digit

Two modulo-47 check digits are automatically calculated and inserted in the bar code symbol. The check digit verifies accurate scanning. The start code is included in the check digit algorithm.

Code 93 Command Format

```
BARCODE
CODE93; [DIR;] [MAG;] [Hn[.m];] [BFn;L;][DARK;] SR;SC
(D) [data field] (D)
[PDF [;LOC] [;FONT]]
STOP
```

BARCODE	The Bar Code command; enter BARCODE .
CODE93	Designates bar code type Code 93; enter CODE93 .
DIR	Optional parameter that allows for rotating a barcode. Enter CW for clockwise rotation. Enter CCW or VSCAN for counter-clockwise rotation. Enter INV for inverted rotation. If <i>DIR</i> is not entered, the barcode is horizontally oriented.
MAG	Optional parameter to magnify (horizontally expand) the bar code symbol. The magnification default value is X1 . Increasing the magnification adjusts printed character density as shown in Table 12, page 106 or Table 13, page 107, depending on your printers tip size. You can also use XR or XRD as defined on page 104. (You must specify 8 digits for <i>MAG</i> for variable ratio.)

NOTE: There are eight values that comprise the dot ratio: narrow bar, narrow space, 2x narrow bar, 2x narrow space, 3x narrow bar, 3x narrow space, 4x narrow bar, and 4x narrow space. User-defined ratios for this barcode should have these eight values defined in the order specified.

Hn[.m]	Optional parameter to adjust the overall height (vertical expansion) of the bar code symbol (including the upper and lower 0.1-inch guard bands and any human readable data). Height adjustments are made in 0.1-inch increments; enter H and a value from 3 through 99 to select height adjustments from 0.3 through 9.9 inches. The default value is 0.9 inch. [.m] is an additional number of dots for the bar code height. (Dots are in the current dot scale.)
--------	--

NOTE: If 0.3 inches is the selected height, the PDF cannot be included.

<i>BFn;L</i>	Optional parameters for assigning a dynamic bar code data field location on a form and for designating the length of the data field. With these parameters, the actual data for the bar code data field is dynamically provided during the Execute Form Mode; the data is not specified during the Create Form Mode. To use this field, perform the following steps: <ol style="list-style-type: none">Enter BF.Replace <i>n</i> with a number ranging from 0 through 512 to identify the bar code field. The <i>SR</i> and <i>SC</i> parameters specify the exact location of the bar code field identified by <i>n</i>.Replace <i>L</i> with a number equaling the total number of characters in the field. (The actual data provided dynamically during the Execute Form Mode can be less than <i>L</i>.)The information for the data field is entered dynamically during the Execute Form Mode. (Refer to Execute Form: Dynamic Bar Code Data on page 62.) Do not use the <i>data field</i> parameter to enter data when the <i>BFn;L</i> parameters are used. However, refer to the <i>data field</i> description for available characters.
DARK	Optional parameter to produce darker looking bar codes. Enter DARK . Refer to Dark Printing on page 52 for more information.
<i>SR</i>	Defines the starting row for the bar code. Enter a value ranging from row 1 to one less than the length of the form. Character row or dot row is specified based on the Scale command (page 95), or use the CP.DP format (page 24).
<i>SC</i>	Defines the starting column of the bar code. Enter a value ranging from column 1 to one less than the width of the form. Character column or dot column is specified based on the Scale command (page 95), or use the CP.DP format (page 24).
<i>(D)</i>	The printable character (delimiter) identifying the start and finish of the data field. Enter any printable character other than a slash (/), the SFCC, or a character used within the data. The same character must be used at both ends of the data field, but it will not print with the data.
<i>data field</i>	Enter the data for the bar code. A null data field (no characters) is permitted. The length of the data field is variable; however, the maximum length is usually limited to 32 characters to minimize potential reading errors. The data field can contain any of the characters listed in Table 17, except the system SFCC.
PDF	Optional parameter to enable printing of the human readable data field. Enter PDF to print the data field. If the parameter is not used, the human readable data will not print. This parameter is not allowed if a null data field was specified.
<i>LOC</i>	Optional parameter to identify the location of the printable data field. The default value is B , locating the human readable data below the bar code. A locates the printable data field above bar code. To compensate for printing the 0.1-inch high data, the height of the bar code body is reduced 0.1 inch.
<i>FONT</i>	Optional parameter to select the font for the human readable data field. Enter O to select OCR-A font; enter X to select OCR-B font; enter N to select 10 cpi; enter P to select 12 cpi; enter Q to select 13 cpi; enter R to select 15 cpi; enter T to select 17 cpi; enter V to select 20 cpi.

To select a scalable font with user-defined size, enter **Nh:w** or **F;Nh:w**. The parameters h (height) and w (width) can each range from 1 to 96, and are expansion factors of a 10 cpi character. Nh:w prints in Letter Gothic (font 93779) regardless of the current active font. By default F;Nh:w uses the Letter Gothic as the current font selection. You can change the default by using the FONT command.

NOTE: Nh:w and F;Nh:w will not print the PDF wider or taller than the barcode. If the height parameter h causes the PDF to print above the horizontal barcode start row or vertical barcode start column, a barcode font Error will occur. If the width parameter w causes the PDF to exceed the barcode width, the PDF width factor w will automatically reduce to fit within the barcode width without causing an error.

STOP Ends the Bar Code command while the IGP continues in the Create Form Mode. Enter **STOP**. If STOP is not entered, an error message results.

Table 17 Code 93 Character Set

Character	Hex	Character	Hex
0	30	P	50
1	31	Q	51
2	32	R	52
3	33	S	53
4	34	T	54
5	35	U	55
6	36	V	56
7	37	W	57
8	38	X	58
9	39	Y	59
A	41	Z	5A
B	42	—	2D
C	43	.	2E
D	44	SPACE	20
E	45	\$	3F
F	46	/	2F
G	47	+	2B
H	48	%	25
I	49	S1	N/A
J	4A	S2	N/A
K	4B	S3	N/A
L	4C	S4	NA
M	4D	Start	N/A
N	4E	Stop	N/A
O	4F		

Code 93 Example

The illustration below shows a horizontal Code 93 bar code generated by the following program:

~CREATE;TEST;288	(Enters Create Form mode)
BARCODE	(Bar code command)
CODE93;X1;H7;10;20	(Code 93 bar code, <i>MAG 1</i> , H 0.7 inches, <i>SR 10</i> , <i>SC 20</i>)
ABCD5678	(Data Field)
PDF;B;N	(Printable data field, 10 cpi font)
STOP	(Ends bar code command)
END	(Terminates Create Form mode)
~EXECUTE;TEST	(Prints form)
~NORMAL	



Code 128A, 128B and 128C

The Code 128 structure is shown in Figure 12 and described on the following pages.

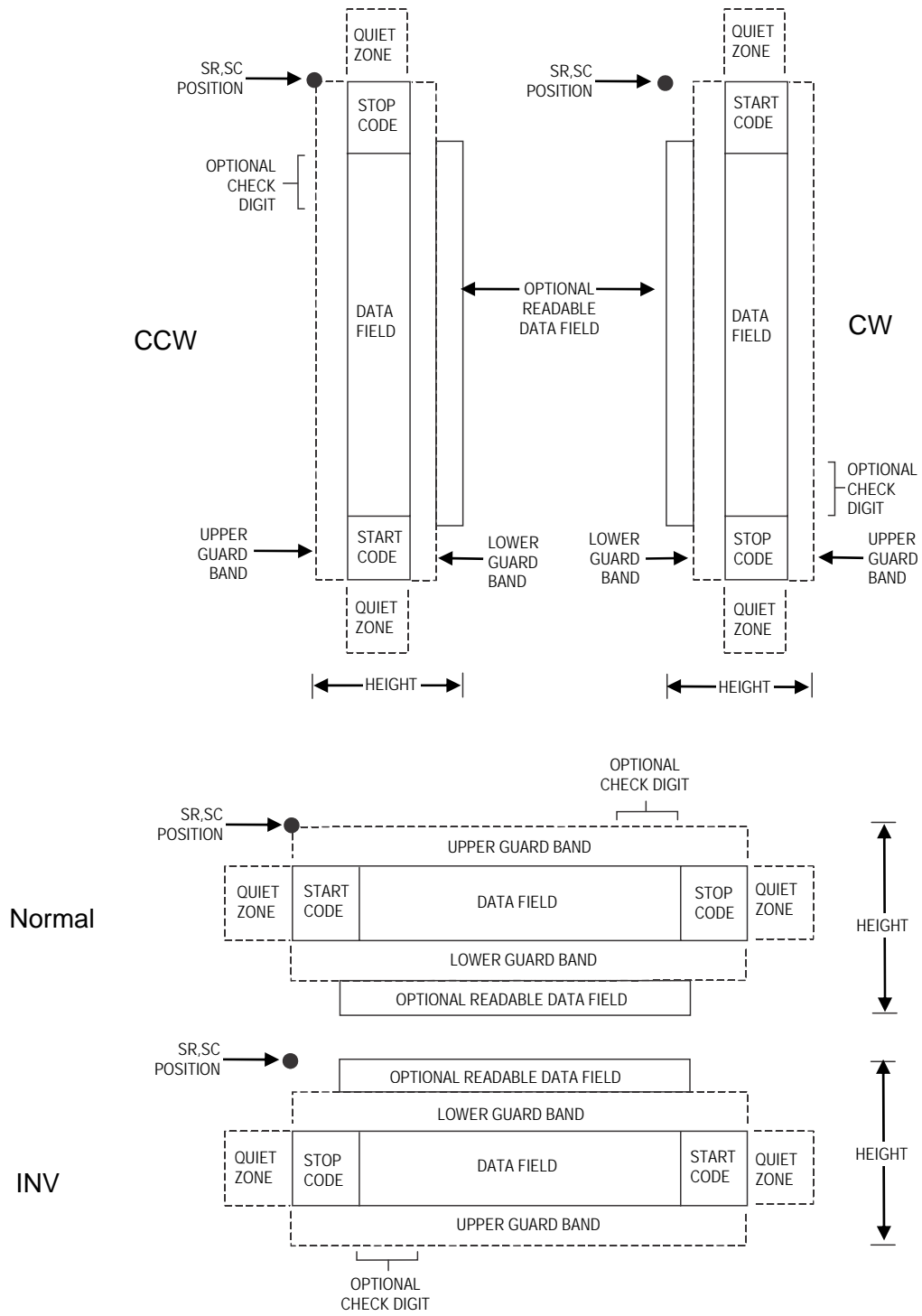

Figure 12 Code 128 Structure

Quiet Zone

Both ends of the bar code structure require blank quiet zones. The quiet zones must be at least 0.25 inches wide and completely blank to ensure accurate reading of the start/stop codes and to prevent adjacent bar codes from overlapping. Be sure to provide sufficient space on the form for the quiet zones.

Start/Stop Codes

The start/stop codes identify the leading and trailing end of the bar code. Each of the Code 128 subsets uses a unique start code and a common stop code, both automatically provided by the IGP. The start/stop code structure permits bidirectional bar code scanning.

Code 128A Data Field

The bar code symbol uses a series of varying width bars and spaces to represent an extensive character set (64 ASCII characters and 32 control characters). The bars and spaces vary in width from one through four modules. Each character consists of three bars and three spaces that total 11 modules.

Code 128B Data Field

The bar code symbol uses a series of varying width bars and spaces to represent an extensive character set (96 ASCII characters and seven control characters). The bars and spaces vary in width from one through four modules. Each character consists of three bars and three spaces that total 11 modules.

Code 128C Data Field

The bar code symbol uses a series of varying width bars and spaces to represent 100 pairs of numeric digits (00 through 99) and 3 control characters. The bars and spaces vary in width from 1 through 4 modules. Each character consists of three bars and three spaces that total 11 modules.

Readable Data

The optional readable data field provides a readable interpretation of the bar code data. It can be printed above or below the bar code symbol.

Data Field

For HIBC barcode, the data field is a variable length consisting of only the following characters: 1-9, A-Z, -, ., \$, /, +, %, and space.

NOTE: The Health Industry Bar Code (HIBC) is encoded in either Code 128 or Code 39 symbology. In a global setting, HIBC identifies health industry products, in any quantity, of any lot or serial number, with any expiration date. HIBC represents two kinds of information: Primary and Secondary Identification. Primary Identification represents product identity and Secondary Identification represents the attributes of Lot or Batch Code, Serial Number, and Expiration date.

Check Digit

The modulo-103 check digit is automatically calculated and inserted in the bar code symbol. The check digit verifies accurate scanning. The start code is included in the check digit algorithm.

For HIBC barcode, a mandatory modulo-43 checklist is inserted at the end of the data.

Code 128 Command Format

```
BARCODE  
C128A or C128B or C128C; [HIBC;] [DIR;] [MAG;] [Hn[.m];]  
[BFn;L;] [DARK;] SR; SC (D) [data field] (D)  
[PDF [;LOC] [;FONT] [;MAX]]  
STOP
```

BARCODE	The Bar Code command; enter BARCODE .
C128A, C128B or C128C	Designates bar code type Code 128; enter C128A , C128B or C128C .
<i>HIBC</i>	<p>The Health Industry Bar Code (HIBC) is encoded in either Code 128 or Code 39 symbology. Enter HIBC. In a global setting, HIBC can uniquely identify any health industry product, in any quantity, of any lot or serial number, with any expiration date. HIBC represents two kinds of information: Primary and Secondary Identification. Primary Identification represents product identity and Secondary Identification represents the attributes of Lot or Batch Code, Serial Number, and Expiration date.</p> <p>When encoding HIBC barcode in UCC-128, HIBC is essentially a UCC-128 barcode. The encoding uses the same module 10 check digit and data format. The only addition is an Application Identifier (AI) parameter. For Primary Data Structure use AI (01), and for Secondary Data Structure use AI (22) or AI (240). To use UCC-128 to encode HIBC, be sure to use the correct AI parameter to obtain the desired results.</p>
<i>DIR</i>	Optional parameter that allows for rotating a barcode. Enter CW for clockwise rotation. Enter CCW or VSCAN for counter-clockwise rotation. Enter INV for inverted rotation. If <i>DIR</i> is not entered, the barcode is horizontally oriented.
<i>MAG</i>	Optional parameter to magnify (horizontally expand) the bar code symbol. The magnification default value is X1 . Increasing the magnification adjusts printed character density as shown in Table 12, page 106 or Table 13, page 107, depending on your printers tip size. You can also use XR or XRD as defined on page 104. (You must specify 8 digits for <i>MAG</i> for variable ratio.) There are eight values that comprise the dot ratio: <i>narrow bar</i> , <i>narrow space</i> , <i>2x narrow bar</i> , <i>2x narrow space</i> , <i>3x narrow bar</i> , <i>3x narrow space</i> , <i>4x narrow bar</i> , and <i>4x narrow space</i> . User-defined ratios for this barcode should have these eight values defined in the order as specified.
<i>Hn[m]</i>	Optional parameter to adjust the overall height (vertical expansion) of the bar code symbol (including the upper and lower 0.1-inch guard bands and any human readable data). Height adjustments are made in 0.1-inch increments; enter H and a value from 3 through 99 to select height adjustments from 0.3 through 9.9 inches. The default value is 0.9 inch. [<i>m</i>] is an additional number of dots for the bar code height. (Dots are in the current dot scale.)

NOTE: If 0.3 inches is the selected height, the PDF cannot be included.

<i>BFn;L</i>	<p>Optional parameters for assigning a dynamic bar code data field location on a form and for designating the length of the data field. With these parameters, the actual data for the bar code data field is dynamically provided during the Execute Form Mode; the data is not specified during the Create Form Mode. To use this field, perform the following steps.</p> <ol style="list-style-type: none"> a. Enter BF. b. Replace <i>n</i> with a number ranging from 0 through 512 to identify the bar code field. The <i>SR</i> and <i>SC</i> parameters specify the exact location of the bar code field identified by <i>n</i>. c. Replace <i>L</i> with a number equaling the total number of characters in the field. (The actual data provided dynamically during the Execute Form Mode can be less than <i>L</i>.)
--------------	--

- d. The information for the data field is entered dynamically during the Execute Form Mode. (Refer to Execute Form: Dynamic Bar Code Data on page 62.) Do not use the *data field* parameter to enter data when the *BFn;L* parameters are used. However, refer to the *data field* description for available characters.

DARK	Optional parameter to produce darker looking bar codes. Enter DARK . Refer to Dark Printing on page 52 for more information.
SR	Defines the starting row for the bar code. Enter a value ranging from row 1 to one less than the length of the form. Character row or dot row is specified based on the Scale command (page 95), or use the CP.DP format (page 24).
SC	Defines the starting column of the bar code. Enter a value ranging from column 1 to one less than the width of the form. Character column or dot column is specified based on the Scale command (page 95), or use the CP.DP format (page 24).
(D)	The printable character (delimiter) identifying the start and finish of the data field. Enter any printable character other than a slash (/), the SFCC, or a character used within the data. The same character must be used at both ends of the data field, but it will not print with the data.
<i>data field</i>	Enter the data for the bar code. A null data field (no characters) is permitted. Whenever a string of 6 or more contiguous numeric digits are detected, the IGP automatically inserts a Code C at the start of the numeric string and outputs numeric digit pairs packed into single bar code characters. When the string is broken (non-numeric data or an unpaired numeric digit occurs), the IGP automatically inserts a Code B and returns to normal C128B symbols. The length of the data field is variable; however, the maximum length is usually limited to 32 characters to minimize potential reading errors. The data field can contain any of the characters listed in Table 18 through Table 20, except the system SFCC.
PDF	Optional parameter to enable printing of the human readable data field. Enter PDF to print the data field. If the parameter is not used, the human readable data will not print. This parameter is not allowed if a null data field was specified.
LOC	Optional parameter to identify the location of the printable data field. The default value is B , locating the human readable data below the bar code. A locates the printable data field above bar code. To compensate for printing the 0.1-inch high data, the height of the bar code body is reduced 0.1 inch.
FONT	Optional parameter to select the font for the human readable data field. Enter O to select OCR-A font; enter X to select OCR-B font; enter N to select 10 cpi; enter P to select 12 cpi; enter Q to select 13 cpi; enter R to select 15 cpi; enter T to select 17 cpi; enter V to select 20 cpi. To select a scalable font with user-defined size, enter Nh:w or F;Nh:w . The parameters h (height) and w (width) can each range from 1 to 96, and are expansion factors of a 10 cpi character. Nh:w prints in Letter Gothic (font 93779) regardless of the current active font. By default F;Nh:w uses the Letter Gothic as the current font selection. You can change the default by using the FONT command.

NOTE: Nh:w and F;Nh:w will not print the PDF wider or taller than the barcode. If the height parameter h causes the PDF to print above the horizontal barcode start row or vertical barcode start column, a

barcode font Error will occur. If the width parameter w causes the PDF to exceed the barcode width, the PDF width factor w will automatically reduce to fit within the barcode width without causing an error.

- MAX** Optional parameter to specify the maximum number of data printed in the PDF. If all data should be printed, do not use this parameter. Valid values are from **1** through **128**. For example, if the barcode data is "12345" and a **MAX** value of 3 is specified, the PDF would print "123".
- STOP** Ends the Bar Code command while the IGP continues in the Create Form Mode. Enter **STOP**. If **STOP** is not entered, an error message results.

Table 18 Code 128A Character Set

Character	Hex	Character	Hex	Character	Hex	Character	Hex
NUL	00	SUB	1A	4	34	N	4E
SOH	01	ESC	1B	5	35	O	4F
STX	02	FS	1C	6	36	P	50
ETX	03	GS	1D	7	37	Q	51
EOT	04	RS	1E	8	38	R	52
ENQ	05	US	1F	9	39	S	53
ACK	06	SP	20	:	3A	T	54
BEL	07	!	21	;	3B	U	55
BS	08	"	22	<	3C	V	56
HT	09	#	23	=	3D	W	57
LF	0A	\$	24	>	3E	X	58
VT	0B	%	25	?	3F	Y	59
FF	0C	&	26	@	40	Z	5A
CR	0D	'	27	A	41	[5B
SO	0E	(28	B	42	\	5C
SI	0F)	29	C	43]	5D
DLE	10	*	2A	D	44		5E
DC1	11	+	2B	E	45	^	5F
DC2	12	,	2C	F	46	FNC 3	23 See NOTE
DC3	13	-	2D	G	47	FNC 2	22 See NOTE
DC4	14	.	2E	H	48	SHIFT	28 See NOTE
NAK	15	/	2F	I	49	CODE C	27 See NOTE
SYN	16	0	30	J	4A	FUNC 4	24 See NOTE
ETB	17	1	31	K	4B	CODE B	26 See NOTE
CAN	18	2	32	L	4C	FNC 1	21 See NOTE
EM	19	3	33	M	4D	START A	(N/A)
						STOP	(N/A)

NOTE: NOTE: Access for the alternate set of control function characters is by using SO (Shift Out, hex 0E). The SO control code identifies the next character as the control function character, and must be inserted before *each* alternate character required. The SO character is selectable from the printer's front panel (see your *Administrator's Guide*).

Table 19 Code 128B Character Set

Character Hex		Character Hex		Character Hex		Character	Hex
SP	20	:	3A	T	54	n	6E
!	21	;	3B	U	55	o	6F
"	22	<	3C	V	56	p	70
#	23	=	3D	W	57	q	71
\$	24	>	3E	X	58	r	72
%	25	?	3F	Y	59	s	73
&	26	@	40	Z	5A	t	74
'	27	A	41	[5B	u	75
(28	B	42	\	5C	v	76
)	29	C	43]	5D	w	77
*	2A	D	44		5E	x	78
+	2B	E	45	-	5F	y	79
,	2C	F	46	`	60	z	7A
-	2D	G	47	a	61	{	7B
.	2E	H	48	b	62		7C
/	2F	I	49	c	63	}	7D
0	30	J	4A	d	64	~	7E
1	31	K	4B	e	65		7F
2	32	L	4C	f	66	FNC 3	23 See NOTE
3	33	M	4D	g	67	FNC 2	22 See NOTE
4	34	N	4E	h	68	SHIFT	28 See NOTE
5	35	O	4F	i	69	CODE C	27 See NOTE
6	36	P	50	j	6A	FUNC 4	24 See NOTE
7	37	Q	51	k	6B	CODE A	25 See NOTE
8	38	R	52	l	6C	FNC 1	21 See NOTE
9	39	S	53	m	6D	START B	(N/A)
						STOP	(N/A)

NOTE: Access for the alternate set of control function characters is by using SO (Shift Out, hex 0E). The SO control code identifies the next character as the control function character, and must be inserted before *each* alternate character required. The SO character is selectable from the printer's front panel (see your *Administrator's Guide*).

Table 20 Code 128C Character Set

Character	Hex	Character	Hex	Character	Hex	Character	Hex
00	30 30	27	32 37	54	35 34	81	38 31
01	30 31	28	32 38	55	35 35	82	38 32
02	30 32	29	32 39	56	35 36	83	38 33
03	30 33	30	33 30	57	35 37	84	38 34
04	30 34	31	33 31	58	35 38	85	38 35
05	30 35	32	33 32	59	35 39	86	38 36
06	30 36	33	33 33	60	36 30	87	38 37
07	30 37	34	33 34	61	36 31	88	38 38
08	30 38	35	33 35	62	36 32	89	38 39
09	30 39	36	33 36	63	36 33	90	39 30
10	31 30	37	33 37	64	36 34	91	39 31
11	31 31	38	33 38	65	36 35	92	39 32
12	31 32	39	33 39	66	36 36	93	39 33
13	31 33	40	34 30	67	36 37	94	39 34
14	31 34	41	34 31	68	36 38	95	39 35
15	31 35	42	34 32	69	36 39	96	39 36
16	31 36	43	34 33	70	37 30	97	39 37
17	31 37	44	34 34	71	37 31	98	39 38
18	31 38	45	34 35	72	37 32	99	39 39
19	31 39	46	34 36	73	37 33	CODE B	26 See NOTE
20	32 30	47	34 37	74	37 34	CODE A	25 See NOTE
21	32 31	48	34 38	75	37 35	FNC 1	21 See NOTE
22	32 32	49	34 39	76	37 36	START C	(N/A)
23	32 33	50	35 30	77	37 37	STOP	(N/A)
24	32 34	51	35 31	78	37 38		
25	32 35	52	35 32	79	37 39		
26	32 36	53	35 33	80	38 30		

NOTE: Access for the alternate set of control function characters is by using SO (Shift Out, hex 0E). The SO control code identifies the next character as the control function character, and must be inserted before *each* alternate character required. The SO character is selectable from the printer's front panel (see your *Administrator's Guide*).

NOTE: There are three subsets of the C128 barcode. Subset A contains numbers, punctuation, uppercase letters and control characters. Subset B contains numbers, punctuation, uppercase and lowercase letters. Subset C encodes pairs of numbers as a single character. Each printed character is three bars and three spaces. One given character may be interpreted as, for example, a carriage return, the letter "m" or the two numbers "77", depending on the subset that is active at the time. Each subset has a start code character which sets the initial subset, and a switch code character which changes the subset. Start code is embedded in the barcode symbology to tell the barcode reader how a character should be interpreted. Switch code is the user input data, 0x25 (to subsetA), 0x26 (to subsetB), and 0x27 (to subsetC), which needs to be

preceded with the SO (Shift Out, 0x0E) character to tell which subset to switch to, and will be replaced with the corresponding start code during the data parsing.

There are three different commands to invoke a C128 barcode in PGL. They are C128A, C128B and C128C. However, these commands do not set the initial subset as you might expect. Instead, the default behavior is that the subset is automatically switched, so that the number of printed characters is minimized by using subset C to print pairs of numerals as a single character, and by avoiding unnecessary subset changes.

The default behavior is called "automatic mode". In automatic mode, no switch codes are included in the data by the user to force one of the subsets to be active. The starting subset as well as any subset switching are selected by the printer automatically. Manual mode is started if the subset switching codes are inserted in the data sent to the printer.

In automatic mode, the starting subset selection criteria are: long strings of number pairs will cause a start in set C; a letter, punctuation, or an unpaired number will cause a start in set B, and a control character will cause a start in set A. After starting in one set, a switch will be automatically be made by PGL if the number of printed characters can be reduced (i.e. a switch to set C to print pairs of numbers with a single character), or if the data cannot be found in the current subset. The printer will switch from A to B for a lowercase letter, from A to C for a long string of paired numbers, from B to A for a control character, from B to C for a long string of paired numbers, from C to A for a control character, and from C to B for an unpaired number or any letter or punctuation. In automatic mode, the printer puts the start codes into the barcode itself; they are not part of the user input data in the PGL barcode command.

If a subset switch code is inserted in the barcode data to start the desired subset, the printer leaves automatic mode and enters "manual mode". However, in manual mode, automatically subset switches can still take place when the data cannot be found in the current subset. Once a different subset is automatically switched due to the data cannot be found in the current specified subset, the switched subset will stay until the end of the data or the encounter of another subset switch code.

If a subset switch code is inserted as the first character in the data string, the barcode will start in that subset. No effort is made to minimize the barcode character count. That means sending the PGL barcode command C128C with data starting with the switch to A code (shiftout and %) followed by ten numerals, will result in barcode characters of Start-A followed by ten numeral characters using subset A.

If a subset switch code is the first character and the next character is not in that character set, the printer may start in the commanded set and then immediately switch to the set that includes the second character. For example, sending a Switch-to-C code followed by a carriage return and 10 numerals may result in a data field of Start-C, Switch-to-A, and ten numerals using subset A. In other words, once manual mode is entered by using a switch code, the user is presumed to be selecting the desired data field; the printer will automatically switch subsets when required to print the correct data characters, but is not required to optimize the barcode length. There is no way to exit manual mode and re-enter automatic mode in the same data stream.

Code 128B Example

Figure 13 illustrates a horizontal and vertical Code 128B bar code generated by the following program:

```
~CREATE;128B          (Enter Create Form Mode)
BARCODE              (Bar Code command)
C128B;DARK;40;15    (Dark Code 128B at SR 40, SC 15)
*SAMPLE CODE 128B*  (Data Field)
PDF;A               (Upper Printable Data Field)
STOP                (Ends Bar Code command)
BARCODE              (New Bar Code command)
C128B;VSCAN;H12;DARK;31;55 (Vert. Dark C128B, H 1.2 at SR 31, SC 55)
*SAMPLE CODE 128B*  (Data Field)
PDF                 (Printable Data Field)
STOP                (Ends Bar Code command)
END                 (Terminate Create Form Mode)
~EXECUTE;128B;1     (Execute the form, form count of 1)
~NORMAL
```



Figure 13 Sample Code 128B Bar Codes

Code 128C Example

Figure 14 illustrates a horizontal and vertical Code 128C bar code generated by the following program:

```
~CREATE;128C                (Enter Create Form Mode)
BARCODE                    (Bar Code command)
C128C;DARK;35;15          (Dark Code 128C at SR 35, SC 15)
*1234567890*              (Data Field)
PDF                        (Printable Data Field)
STOP                      (Ends Bar Code command)
BARCODE                    (New Bar Code command)
C128C;VSCAN;H12;DARK;27;50 (Vert. Dark C128C, H 1.2 at SR 27, SC 50)
*1234567890*              (Data Field)
PDF                        (Printable Data Field)
STOP                      (Ends Bar Code command)
END                        (Terminates Create Form Mode)
~EXECUTE;128C;1           (Execute the form, form count of 1)
~NORMAL
```



Figure 14 Sample Code 128C Bar Codes

EAN 8

The EAN 8 bar code structure is shown in Figure 15 and described on the following pages.

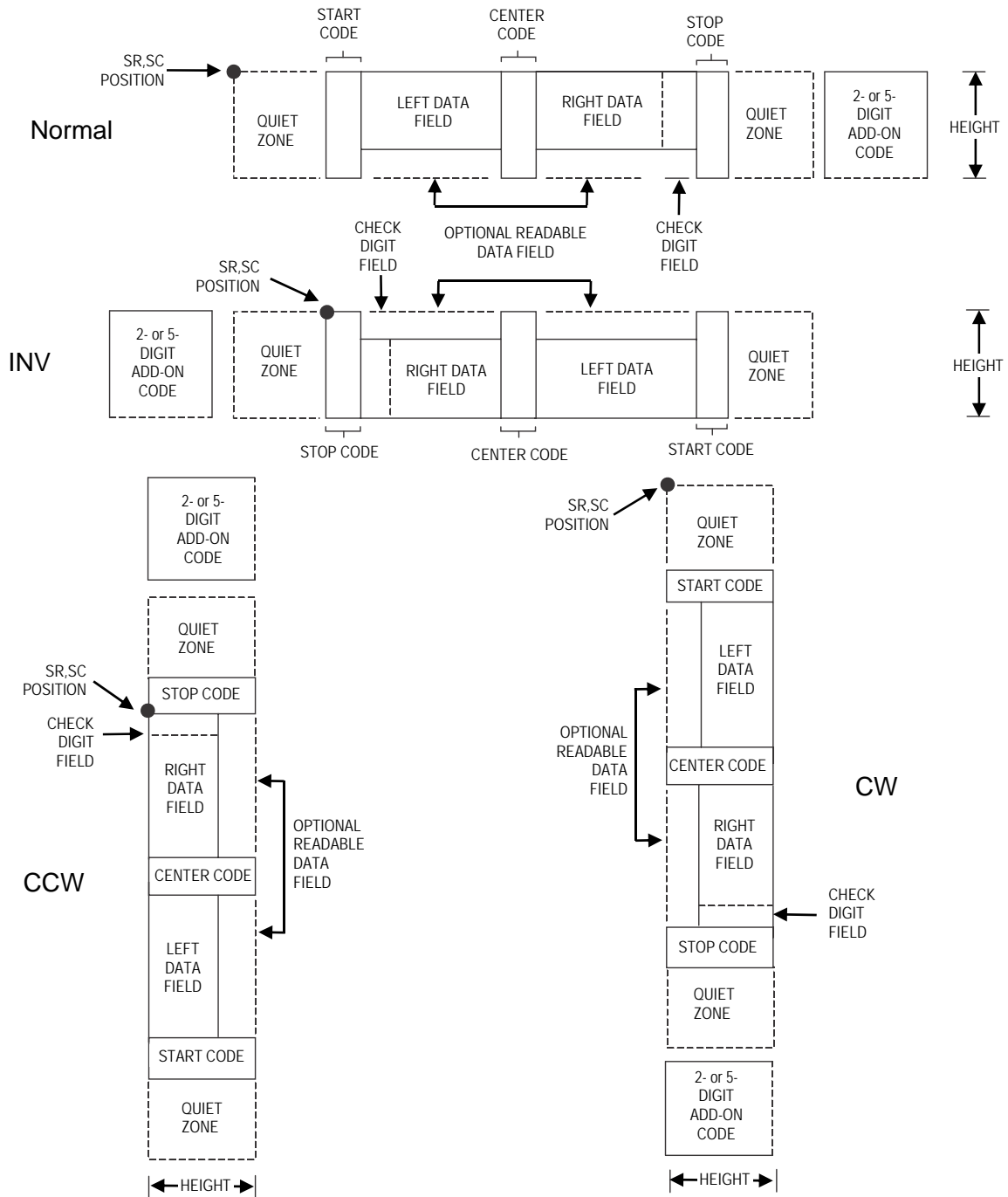

Figure 15 EAN 8 Structure

Quiet Zone

Both ends of the bar code structure have blank quiet zones. The quiet zones must be at least 0.25 inches wide and completely blank to ensure accurate reading of the start/stop codes and to prevent adjacent bar codes from overlapping. The IGP automatically produces the left quiet zone; you must provide sufficient space on the form for the right quiet zone.

Start/Center/Stop Codes

The start/center/stop codes are special character codes marking those portions of the bar code. These codes are automatically provided.

Data Field

The bar code symbol uses a series of varying width bars and spaces to represent a limited character set (numbers 0-9 and Special Characters Start, Center, and Stop). The bars and spaces vary in width from one through four modules. Each character consists of two bars and two spaces that total seven modules. The symbol coding of the left data field is different from the right data field to permit read direction sensing.

The optional 2- or 5-digit add-on data, placed within the quotes at the end of the bar code, typically identifies a periodical issue number or price, respectively.

Readable Data

The human readable data field provides a readable interpretation of the bar code data. It can either be suppressed or printed below the bar code symbol.

Check Digit

The modulo-10 check digit is automatically calculated and inserted in the bar code symbol. The check digit verifies accurate scanning.

EAN 8 Command Format

BARCODE

EAN8 [+n]; [DIR;] [SCB;] [MAG;] [Hn[.m];] [BFn;] [DARK;] SR; SC (D)data field(D) [PDF [;LOC] [;FONT]]

STOP

BARCODE	The Bar Code command; enter BARCODE .
EAN8	Designates bar code type EAN 8; enter EAN8 .
+n	Optional parameter to provide a 2- or 5-digit add-on code at the end of the bar code data field. Enter a plus sign (+) and a value of 2 or 5 . The first bar of the add-on code is separated by nine modules from the last bar of the EAN symbol and a left guard pattern. No center or right guard pattern exists.
DIR	Optional parameter that allows for rotating a barcode. Enter CW for clockwise rotation. Enter CCW or VSCAN for counter-clockwise rotation. Enter INV for inverted rotation. If <i>DIR</i> is not entered, the barcode is horizontally oriented.
SCB	This option shortens the length of the center guard bars, which are normally full length. Enter SCB .
MAG	Optional parameter to magnify (horizontally expand) the bar code symbol. The magnification default value is X1 . Increasing the magnification adjusts printed character density as shown in Table 12, page 106 or Table 13, page 107, depending on your printers tip size. You can also use XR or XRD as defined on page 104. You must specify 8 digits for <i>MAG</i> for variable ratio.

NOTE: There are eight values that comprise the dot ratio: narrow bar, narrow space, 2x narrow bar, 2x narrow space, 3x narrow bar, 3x narrow space, 4x narrow bar, and 4x narrow space. User-defined ratios for this barcode should have these eight values defined in the order specified.

$Hn[.m]$	Optional parameter to adjust the overall height (vertical expansion) of the bar code symbol (including the upper and lower 0.1-inch guard bands and any human readable data). Height adjustments are made in 0.1-inch increments; enter H and a value from 2 through 99 to select height adjustments from 0.2 through 9.9 inches. If any value less than 3 is selected, then the PDF must be suppressed using the PDF Font parameter S . The default value is 1.3 inches. $[.m]$ is an additional number of dots for the bar code height. (Dots are in the current dot scale.)
BFn	Optional parameter for assigning a dynamic bar code data field location on a form. With this parameter, the actual data for the bar code data field is dynamically provided during the Execute Form Mode; the data is not specified during the Create Form Mode. To use this field: <ol style="list-style-type: none">Enter BF.Replace n with a number ranging from 0 through 512 to identify the bar code field. The <i>SR</i> and <i>SC</i> parameters specify the exact location of the bar code field identified by n.The length of the data field need not be specified since it is fixed at seven digits, plus any add-on data.The information for the data field is entered dynamically during the Execute Form Mode. (Refer to Execute Form: Dynamic Bar Code Data on page 62.) Do not use the <i>data field</i> parameter to enter data when the BFn parameters are used. However, refer to the <i>data field</i> description for available characters.
DARK	Optional parameter to produce darker looking bar codes. Enter DARK . Refer to Dark Printing on page 52 for more information.
<i>SR</i>	Defines the starting row for the bar code. Enter a value ranging from row 1 to one less than the length of the form. Character row or dot row is specified based on the Scale command (page 95), or use the CP.DP format (page 24).
<i>SC</i>	Defines the starting column of the bar code. Enter a value ranging from column 1 to one less than the width of the form. Character column or dot column is specified based on the Scale command (page 95), or use the CP.DP format (page 24).
(D)	The printable character (delimiter) identifying the start and finish of the data field. Enter any printable character other than a slash (/), the SFCC, or a character used within the data. The same character must be used at both ends of the data field, but it is not printed with the data.
<i>data field</i>	The characters of the bar code data are restricted to exactly seven digits. If the 2- or 5-digit add-on data option is used, include this data at the end of the data field. The characters available for the data field are 0 through 9 (hex 30 through 39).
PDF	Optional parameter to print the human readable data field. The data field prints automatically unless the PDF-suppress command is specified in the <i>FONT</i> parameter. The human readable data field can be printed above or below the bar code symbol. This parameter is not allowed if a null data field is specified. If no PDF command is entered, the data field will print automatically in the default OCR-B font.

LOC Optional parameter to identify the location of the printable data field. The default value is **B**, locating the human readable data below the bar code. **A** locates the printable data field above bar code. To compensate for printing the 0.1-inch high data, the height of the bar code body is reduced 0.1 inch.

FONT Optional parameter to select the font for the human readable data field. Enter **O** to select OCR-A font; enter **X** to select OCR-B font; enter **N** to select 10 cpi; enter **P** to select 12 cpi; enter **Q** to select 13 cpi; enter **R** to select 15 cpi; enter **T** to select 17 cpi; enter **V** to select 20 cpi. Enter **S** to suppress the PDF entirely.

To select a scalable font with user-defined size, enter **Nh:w** or **F;Nh:w**. The parameters h (height) and w (width) can each range from 1 to 96, and are expansion factors of a 10 cpi character. Nh:w prints in Letter Gothic (font 93779) regardless of the current active font. By default F;Nh:w uses the Letter Gothic as the current font selection. You can change the default by using the FONT command.

NOTE: Nh:w and F;Nh:w will not print the PDF wider or taller than the barcode. If the height parameter h causes the PDF to print above the horizontal barcode start row or vertical barcode start column, a barcode font Error will occur. If the width parameter w causes the PDF to exceed the barcode width, the PDF width factor w will automatically reduce to fit within the barcode width without causing an error.

STOP Ends the Bar Code command while the IGP continues in the Create Form Mode. Enter **STOP**. If STOP is not entered, an error message results.

EAN 8 Example

Figure 16 illustrates a horizontal and vertical EAN 8 bar code generated by the following program:

```
~CREATE;EAN8                (Enter Create Form Mode)
BARCODE                      (Bar Code command)
EAN8+2;H9;DARK;33;15        (Dark Code EAN 8, 2-digit add-on,
                             H 0.9, SR 33, SC 15)
*123456722*                 (Data Field + 2-digit add-on Data Field)
PDF                           (Printable Data Field)
STOP                          (Ends Bar Code command)
BARCODE                      (New Bar Code command)
EAN8+2;VSCAN;H10;DARK;33;55 (Vertical Dark EAN 8, 2-digit add-on,
                             H 1.0, SR 33, SC 55)
*123456722*                 (Data Field + 2-digit add-on Data Field)
PDF                           (Printable Data Field)
STOP                          (Ends Bar Code command)
END                            (Terminates Create Form Mode)
~EXECUTE;EAN8;1              (Execute the form, form count of 1)
~NORMAL
```



Figure 16 Sample EAN 8 Bar Code

EAN 13

The EAN 13 bar code structure is shown in Figure 17 and described on the following pages.

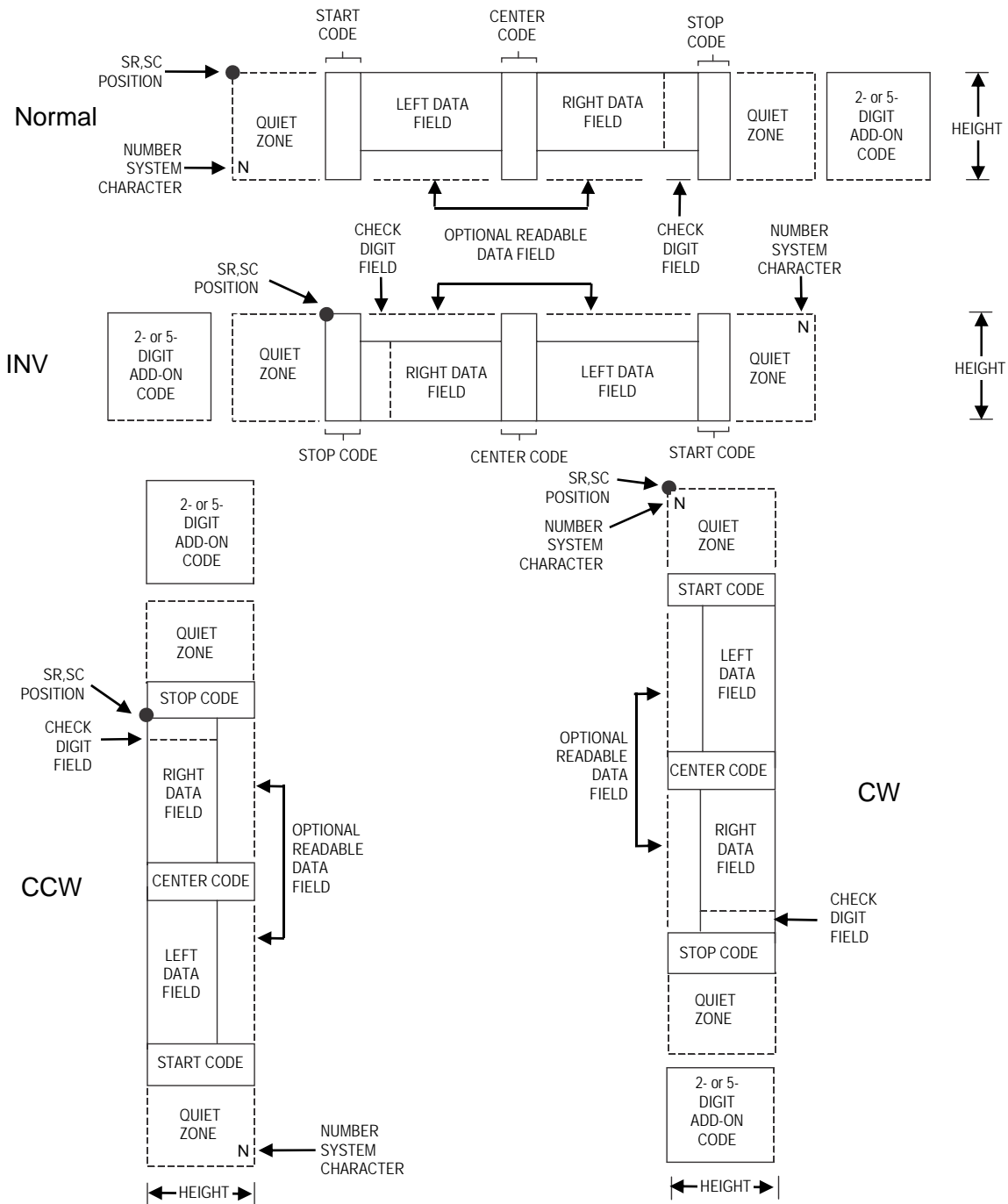

Figure 17 EAN 13 Structure

Quiet Zone

Quiet zones extend on both ends of the bar code to permit the scan to begin and end in a blank area. The IGP automatically produces an 11-module wide left quiet zone; you are responsible for providing sufficient space (minimum of seven modules) on the form for the right quiet zone. The number system character is also printed automatically in the left quiet zone.

Start/Center/Stop Codes

The start/center/stop codes are special character codes marking those portions of the bar code. These codes are automatically provided.

Number System Character

The number system character field allows you to provide a code to a class or type of item. The first character in the data field is used as the number system character.

Data Field

The bar code symbol uses a series of varying width bars and spaces to represent a limited character set (numbers 0-9 and Special Characters Start, Center, and Stop). The bars and spaces vary in width from one through four modules. Each character consists of two bars and two spaces that total seven modules. The symbol coding of the left data field is different from the right data field to permit read direction sensing.

The optional 2 or 5-digit add-on data field is placed within the quotes at the end of the bar code data and typically identifies a periodical issue number or price, respectively.

Readable Data

The human readable data field provides a readable interpretation of the bar code data. It can either be suppressed or printed below the bar code symbol.

Check Digit

The modulo-10 check digit is automatically calculated and inserted in the bar code symbol. The check digit verifies accurate scanning. The number system character is included in the check digit algorithm.

EAN 13 Command Format

BARCODE
EAN13 [+n]; [DIR;] [SCB;] [MAG;] [Hn[.m];] [BFn;] [DARK;]SR;SC
(D)data field(D)
[PDF [;LOC] [;FONT]]
STOP

BARCODE	The Bar Code command; enter BARCODE .
EAN13	Designates bar code type EAN 13; enter EAN13 .
+n	Optional parameter to provide a 2- or 5-digit add-on code at the end of the bar code data field. Enter a plus sign (+) and a value of 2 or 5 . The first bar of the add-on code is separated by nine modules from the last bar of the EAN symbol and a left guard pattern. No center or right guard pattern exists.
DIR	Optional parameter that allows for rotating a barcode. Enter CW for clockwise rotation. Enter CCW or VSCAN for counter-clockwise rotation. Enter INV for inverted rotation. If <i>DIR</i> is not entered, the barcode is horizontally oriented.
SCB	This option shortens the length of the center guard bars, which are normally full length. Enter SCB .

MAG Optional parameter to magnify (horizontally expand) the bar code symbol. The magnification default value is **X1**. Increasing the magnification adjusts printed character density as shown in Table 12, page 106 or Table 13, page 107, depending on your printers tip size. You can also use XR or XRD as defined on page 104. (You must specify 8 digits for **MAG** for variable ratio.)

NOTE: There are eight values that comprise the dot ratio: narrow bar, narrow space, 2x narrow bar, 2x narrow space, 3x narrow bar, 3x narrow space, 4x narrow bar, and 4x narrow space. User-defined ratios for this barcode should have these eight values defined in the order specified.

Hn[.m] Optional parameter to adjust the overall height (vertical expansion) of the bar code symbol (including the upper and lower 0.1-inch guard bands and any human readable data). Height adjustments are made in 0.1-inch increments; enter **H** and a value from **2** through **99** to select height adjustments from 0.2 through 9.9 inches. If any value less than 3 is selected, then the PDF must be suppressed using the **PDF Font** parameter **S**. The default value is 1.3 inches. [.m] is an additional number of dots for the bar code height. (Dots are in the current dot scale.)

BFn Optional parameter for assigning a dynamic bar code data field location on a form. With this parameter, the actual data for the bar code data field is dynamically provided during the Execute Form Mode; the data is not specified during the Create Form Mode. To use this field, perform the following steps:

- Enter **BF**.
- Replace *n* with a number ranging from **0 through 512** to identify the bar code field. The *SR* and *SC* parameters specify the exact location of the bar code field identified by *n*.
- The length of the data field need not be specified, since it is fixed at 12 digits, plus any add-on data.
- The information for the data field is entered dynamically during the Execute Form Mode. (Refer to Execute Form: Dynamic Bar Code Data on page 62.) Do not use the *data field* parameter to enter data when the **BFn** parameters are used. However, refer to the *data field* description for available characters.

DARK Optional parameter to produce darker looking bar codes. Enter **DARK**. Refer to Dark Printing on page 52 for more information.

SR Defines the starting row for the bar code. Enter a value ranging from row 1 to one less than the length of the form. Character row or dot row is specified based on the Scale command (page 95), or use the CP.DP format (page 24).

SC Defines the starting column of the bar code. Enter a value ranging from column 1 to one less than the width of the form. Character column or dot column is specified based on the Scale command (page 95), or use the CP.DP format (page 24).

(D) The printable character (delimiter) identifying the start and finish of the data field. Enter any printable character other than a slash (/), the SFCC, or a character used within the data. The same character must be used at both ends of the data field, but it is not printed with the data.

data field Enter the characters of the bar code data, restricted to exactly 12 digits. If the 2- or 5-digit add-on data option is used, include this data at the end of the data field. The characters available for the data field are **0** through **9** (hex 30 through 39). The first character is interpreted as the number system character.

The left side of the data field (or lower side on vertically oriented symbols) can be encoded in either format A or format B as determined by the value of the number system character. (A bar code character is not produced for the number system character.) The number system character is derived from the left side data field encoding. The right side of the data field (or upper side on vertically oriented symbols) and check digit are always encoded in format C. Table 21 defines the left side data field format based on the number system character.

PDF Optional parameter which affects printing of the human readable data field. The data field will print automatically in the OCR-B font (default) unless the PDF-suppress command is specified in the *FONT* parameter. The human readable data field can be printed above or below the bar code symbol. This parameter is not allowed if a null data field is specified.

LOC Optional parameter to identify the location of the printable data field. The default value is **B**, locating the human readable data below the bar code. **A** locates the printable data field above bar code. To compensate for printing the 0.1-inch high data, the height of the bar code body is reduced 0.1 inch.

FONT Optional parameter to select the font for the human readable data field. Enter **O** to select OCR-A font; enter **X** to select OCR-B font; enter **N** to select 10 cpi; enter **P** to select 12 cpi; enter **Q** to select 13 cpi; enter **R** to select 15 cpi; enter **T** to select 17 cpi; enter **V** to select 20 cpi. Enter **S** to suppress the PDF entirely.

To select a scalable font with user-defined size, enter **Nh:w** or **F;Nh:w**. The parameters h (height) and w (width) can each range from 1 to 96, and are expansion factors of a 10 cpi character. Nh:w prints in Letter Gothic (font 93779) regardless of the current active font. By default F;Nh:w uses the Letter Gothic as the current font selection. You can change the default by using the *FONT* command.

NOTE: Nh:w and F;Nh:w will not print the PDF wider or taller than the barcode. If the height parameter h causes the PDF to print above the horizontal barcode start row or vertical barcode start column, a barcode font Error will occur. If the width parameter w causes the PDF to exceed the barcode width, the PDF width factor w will automatically reduce to fit within the barcode width without causing an error.

STOP Ends the Bar Code command while the IGP continues in the Create Form Mode. Enter **STOP**. If STOP is not entered, an error message results.

Table 21 Left Side Data Field Format

Number System Character Value	Format for Left Side Data Field Positions					
	12	11	10	9	8	7
0	A	A	A	A	A	A
1	A	A	B	A	B	B
2	A	A	B	B	A	B
3	A	A	B	B	B	A
4	A	B	A	A	B	B
5	A	B	B	A	A	B
6	A	B	B	B	A	A
7	A	B	A	B	A	B
8	A	B	A	B	B	A
9	A	B	B	A	B	A

EAN 13 Example

Figure 18 illustrates a horizontal and vertical EAN 13 bar code generated by the following program:

```
~CREATE;EAN13          (Enter Create Form Mode)
BARCODE                (Bar Code Command)
EAN13+5;DARK;28;15    (Dark Code EAN 13, 5-digit add on,
                     at SR 28, SC 15)
*12345678987655555*  (Data Field + 5-digit add-on Data Field)
PDF                    (Printable Data Field)
STOP                  (Ends Bar Code command)
BARCODE                (New Bar Code command)
EAN13+5;VSCAN;H12;DARK;27;39 (Vertical Dark EAN 13, 2-digit add on,
                     H 1.2, at SR 27, SC 39)
*12345678987655555*  (Data Field + 5-digit add on Data Field)
PDF                    (Printable Data Field)
STOP                  (Ends Bar Code command)
END                    (Terminates Create Form Mode)
~EXECUTE;EAN13;1      (Execute the form, form count of 1)
~NORMAL
```



Figure 18 Sample EAN 13 Bar Codes

FIM

The FIM (Facing Identification Mark) bar code structure is shown in Figure 19 and Figure 20 and described on the following pages. The left boundary must begin 3 inches from the right edge of the mail piece. The right-most bar must be 2 inches \pm 1/8-inch from the right edge of the mail piece. Bars must be 5/8-inch \pm 1/8-inch tall; the top of the bars must be no lower than 1/8-inch from the top edge of the mail piece (and may touch the top edge of the mail piece). The bar code baseline must be within 1/8-inch from the bottom edge of the clear zone.

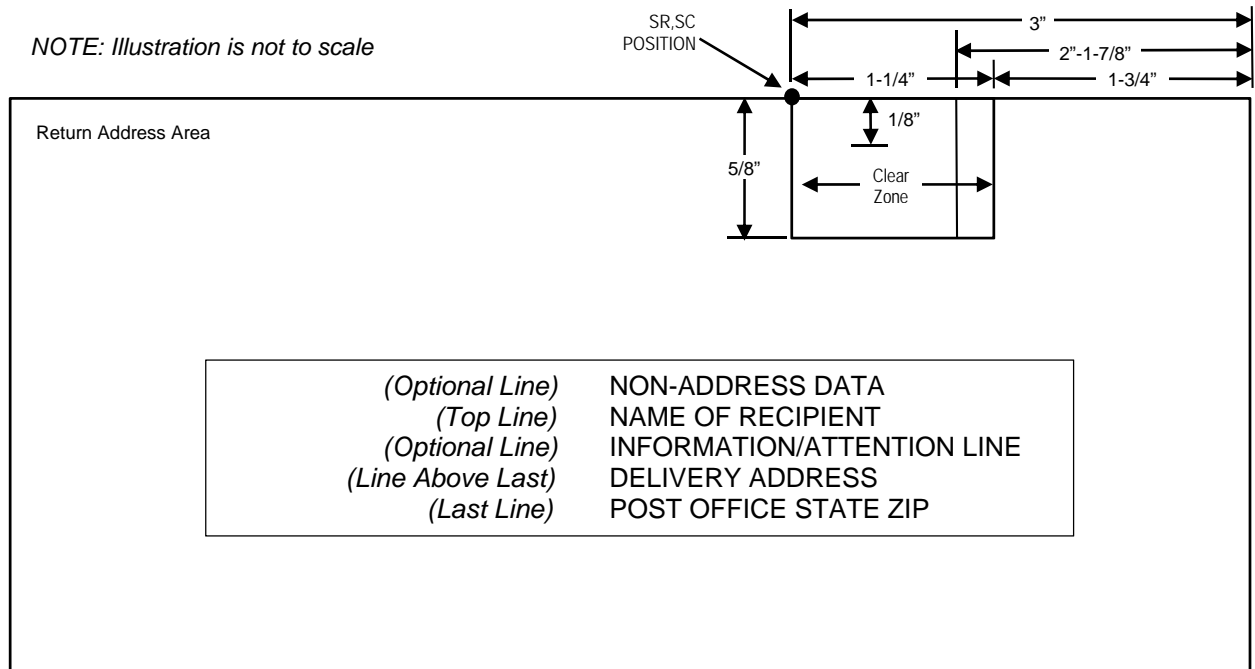
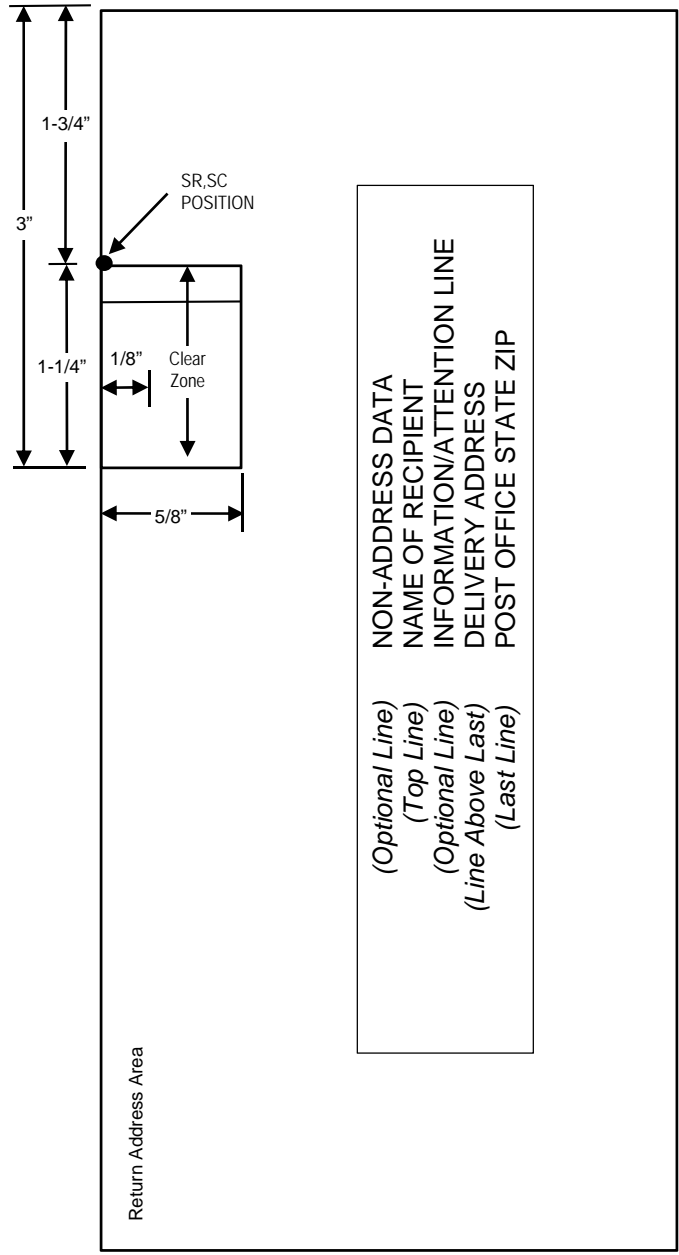

Figure 19 FIM Structure



NOTE: Illustration is not to scale

Figure 20 FIM Structure (VSCAN or CCW)

NOTE: Additional information regarding FIM bar code requirements can be obtained from the U.S. Postal Service's Publication 25: *A Guide to Business Mail Preparation*.

Clear Zone

The bar code structure requires a completely blank, 1/4-inch wide, 5/8-inch tall clear zone, reserved for only the appropriate FIM pattern. You must provide sufficient space for this zone.

Start/Stop Code

The start/stop code is a unique character identifying the leading and trailing end of the bar code. The start/stop code is automatically produced with each bar code. The start/stop code structure permits bidirectional bar code scanning.

Data Field

The bar code symbol uses a nine-position bar/no-bar pattern of tall (full) bars of uniform height. Minimum height must be 5/8-inch \pm 1/8-inch. (Bar height may be longer to wrap around the top of the envelope.) Minimum bar width is .031-inch \pm .008-inch. Spacing (pitch) between each bar/no-bar must be 1/16-inch. Bar tilt (slant) can vary \pm 5 degrees (relative to a line perpendicular to the top edge of the envelope).

FIM Command Format

BARCODE

FIM; [*DIR*]; [*Hn*].*m*]; [*BFn*]; [*DARK*]; *SR*; *SC*

(*D*)*data field*(*D*)

STOP

BARCODE	The Bar Code command; enter BARCODE .
FIM	Designates bar code type FIM; enter FIM .
<i>DIR</i>	Optional parameter that allows for rotating a barcode. Enter CW for clockwise rotation. Enter CCW or VSCAN for counter-clockwise rotation. Enter INV for inverted rotation. If <i>DIR</i> is not entered, the barcode is horizontally oriented.
<i>Hn</i>]. <i>m</i>]	Optional parameter to adjust the overall height (vertical expansion) of the bar code symbol (including the upper and lower 0.1-inch guard bands and any human readable data). Height adjustments are made in 0.1-inch increments; enter H and a value from 2 through 99 to select height adjustments from 0.2 through 9.9 inches. If any value less than 3 is selected, then the PDF must be suppressed using the PDF Font parameter S . The default value is 1.3 inches. [<i>m</i>] is an additional number of dots for the bar code height. (Dots are in the current dot scale.)
<i>BFn</i>	Optional parameter for assigning a dynamic bar code data field location on a form. With this parameter, the actual data for the bar code data field is dynamically provided during the Execute Form Mode; the data is not specified during the Create Form Mode. To use this field, perform the following steps: <ol style="list-style-type: none">Enter BF.Replace <i>n</i> with a number ranging from 0 through 512 to identify the bar code field. The <i>SR</i> and <i>SC</i> parameters specify the exact location of the bar code field identified by <i>n</i>.The information for the data field is entered dynamically during the Execute Form Mode. (Refer to Execute Form: Dynamic Bar Code Data on page 62.) Do not use the <i>data field</i> parameter to enter data when the <i>BFn</i> parameters are used. Refer to the <i>data field</i> description for available characters.

DARK	Optional parameter to produce darker looking bar codes. Enter DARK . Refer to Dark Printing on page 52 for more information.
SR	Defines the starting row for the bar code. Enter a value 1/8-inch from the top edge of the mail piece. Character row or dot row is specified based on the Scale command (page 95), or use the CP.DP format (page 24).
SC	Defines the starting column of the bar code. Enter a value ranging from column 1 to one less than the width of the form. Character column or dot column is specified based on the Scale command (page 95), or use the CP.DP format (page 24).
(D)	The printable character (delimiter) identifying the start and finish of the data field. Enter any printable character other than a slash (/), the SFCC, or a character used within the data. The same character must be used at both ends of the data field, but it is not printed with the data.
<i>data field</i>	<p>A single-character data field to designate one of four available FIM patterns: A, B, C, or D. Based on your application (check with your Postal Service for more information), enter one of the following FIM types:</p> <p>A Used only on courtesy reply envelopes bearing a preprinted POSTNET bar code (page 216); it requires a luminescent stamp or meter mark to be accepted in the facer/canceler.</p> <p>B Used on Business Reply Mail, Penalty Mail, and Franked Mail without a preprinted POSTNET bar code, and does not require luminescent indicia.</p> <p>C Used on Business Reply Mail, Penalty Mail, or Franked Mail bearing a preprinted POSTNET bar code (page 216).</p> <p>D Used on OCR readable mail (usually courtesy reply window envelopes) without a preprinted POSTNET bar code.</p>
STOP	Ends the Bar Code command while the IGP continues in the Create Form Mode. Enter STOP . If STOP is not entered, an error message results.

FIM Example

Figure 21 below illustrates a horizontal FIMB bar code generated by the following program without the POSTNET preprinted bar code (POSTNET is discussed on page 216.)

```

~CREATE;FIMB                (Enter Create Form Mode)
ALPHA                       (Alpha command)
23;11;0;0;*ACME MOTOR, INC.*
25;11;0;0;*ATTN: CUSTOMER SERVICE*
27;11;0;0;*P.O. BOX 200*
29;11;0;0;*USCITY, CA 12345-6789*
STOP                        (Ends Alpha command)
BARCODE                     (Bar Code command)
FIM;DARK;15;22              (Dark FIM Bar Code at SR 15, SC 22)
*B*                         (Data field selecting FIMB Bar Code)
STOP                        (Ends FIMB Bar Code command)
END                         (Terminates Create Form Mode)
~EXECUTE;FIMB;1             (Executes the form, form count of 1)
~NORMAL

```

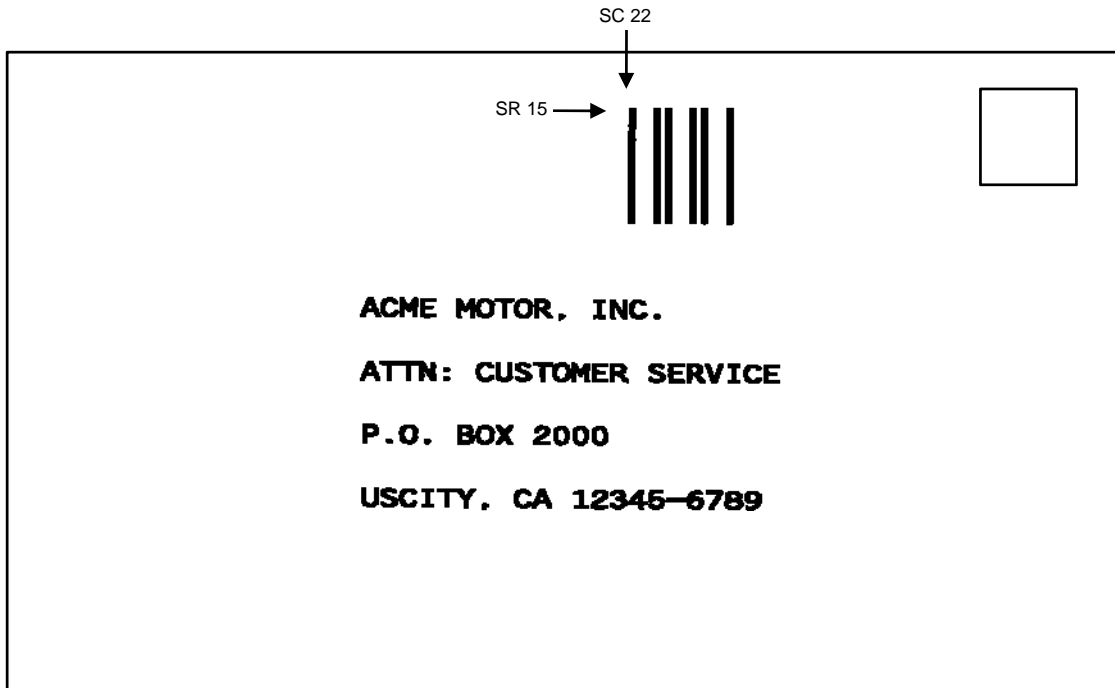

Figure 21 Sample FIMB Bar Code

Figure 22 illustrates a horizontal FIMC bar code generated by the following program and bears the preprinted POSTNET bar code.

```

~CREATE;FIMC                (Enter Create Form Mode)
ALPHA                       (Alpha command)
23;11;0;0;*ACME MOTOR, INC.*
25;11;0;0;*ATTN: CUSTOMER SERVICE*
27;11;0;0;*P.O. BOX 2000*
29;11;0;0;*USCITY, CA 12345-6789*
STOP                        (Ends Alpha command)
BARCODE                     (Bar Code command)
FIM;DARK;17;25             (Dark FIM Bar Code at SR 17, SC 25)
*C*                         (Data field selecting FIMC Bar Code)
STOP                        (Ends Bar Code command)
BARCODE                     (New Bar Code command)
POSTNET;DARK;33.3;15      (Dark POSTNET Bar Code at SR 33.3, SC 15)
*927149559*               (POSTNET data field)
STOP                        (Ends POSTNET Bar Code command)
END                         (Terminates Create Form Mode)
~EXECUTE;FIMC;1           (Executes the form, form count of 1)
~NORMAL

```

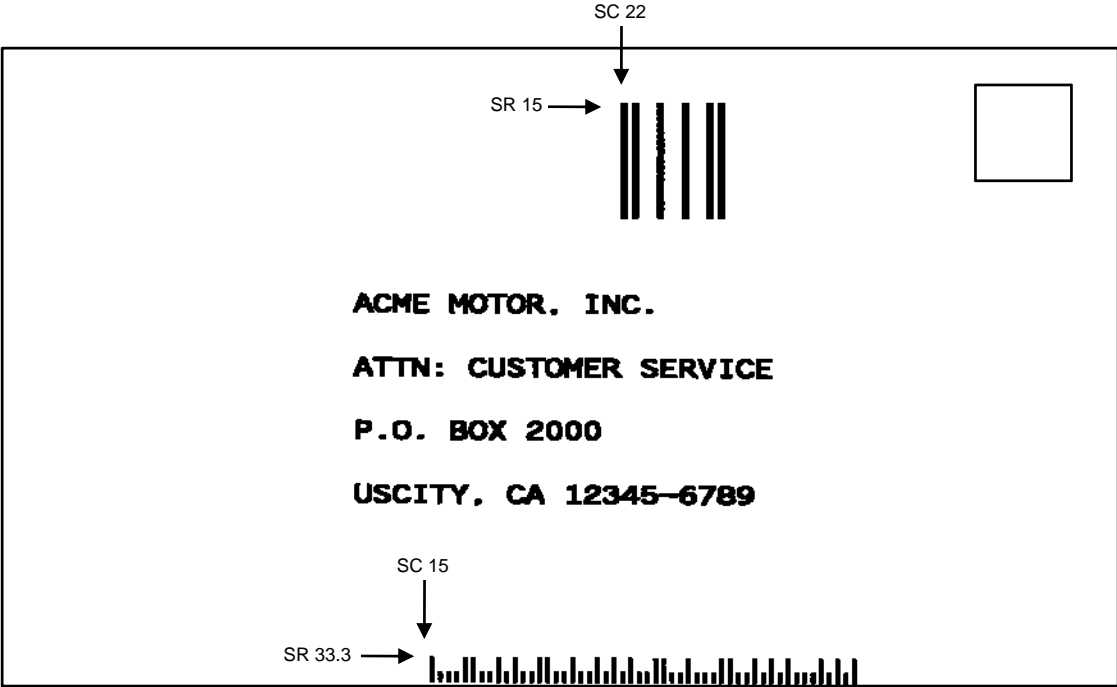

Figure 22 Sample FIMC Bar Code

GS1-128

NOTE: GS1-128 is formerly known as UCC/EAN-128.

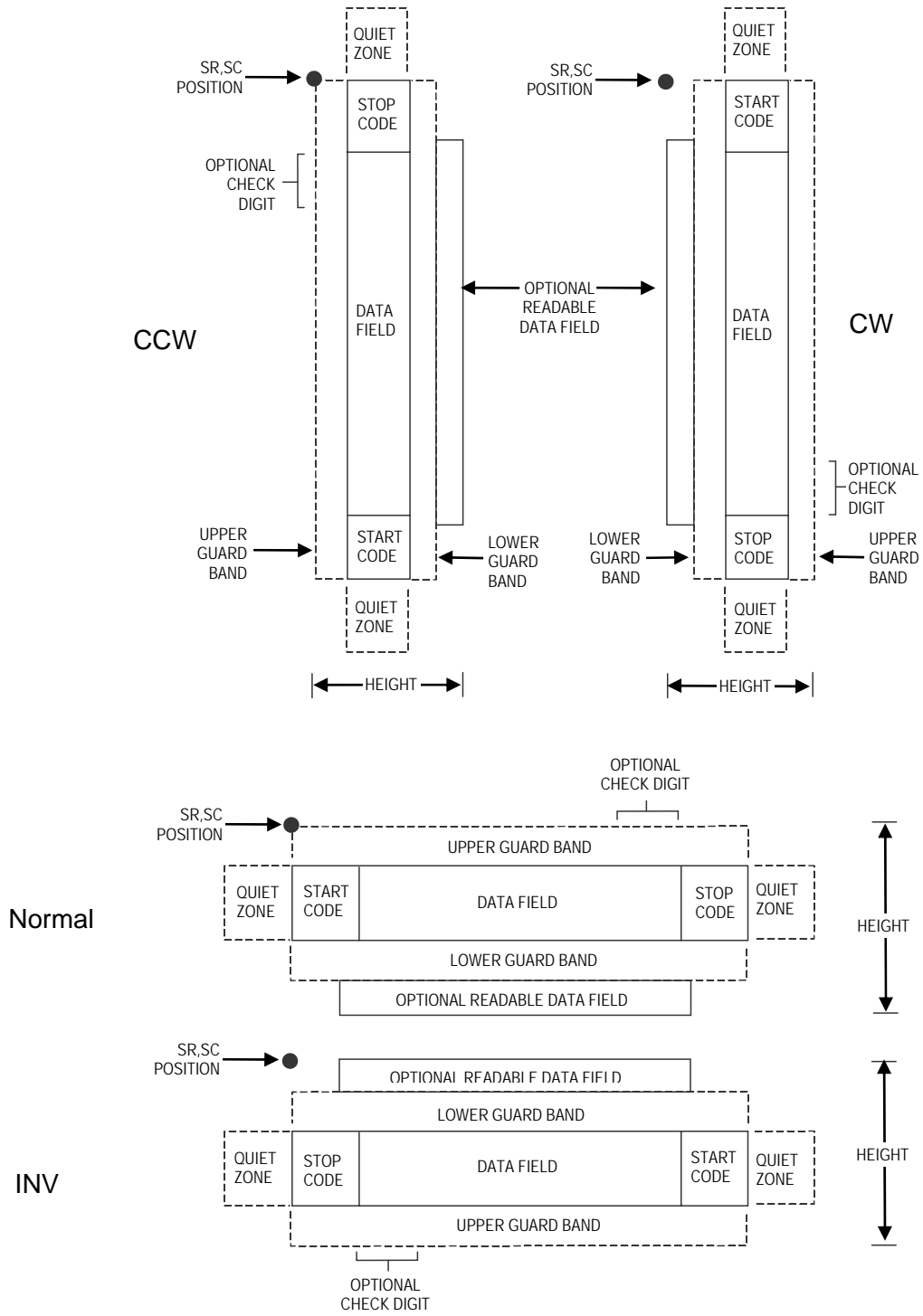

Figure 23 GS1-128 Structure

UCC/EAN-128 uses the same bar code and character set as Code 128. However, in UCC/EAN-128, the Function 1 character FNC1 immediately follows the start code. The FNC1 character has been reserved exclusively for UCC/EAN-128.

The UCC/EAN-128 data structure requires an Application Identifier (AI) at the beginning of bar code data. Each AI determines the format and length of the data which follows. Refer to Table 22 for more details. Each AI field in the barcode data needs to be separated with <SO>!, where <SO> is the default OxE.

Table 22 UCC/EAN-128 Application Identifiers

Application Identifier (AI)	Content	Format
00	Serial Shipping Container Code	n2+n18
01	Global Trade Item Number™	n2+n14
02	Item Num. of Goods Within Another Unit	n2+n14
10	Batch or Lot Number	n2+an..20
11 (*)	Production Date (YYMMDD)	n2+n6
12	Due Date (YYMMDD)	n2+n6
13 (*)	Packaging Date (YYMMDD)	n2+n6
15 (*)	Sell By Date (Quality) (YYMMDD)	n2+n6
17 (*)	Expiration Date (Safety) (YYMMDD)	n2+n6
20	Product Variant	n2+n2
21	Serial Number	n2+an..20
22	HIBC = Quantity, Date, Batch and Link	n2+an..29
23 (**)	Lot Number (Transitional Use)	n3+n..19
37	Quantity of Units Contained (For Use With AI 02 Only)	n2+n..8
240	Additional Product ID Assigned By Manufacturer	n3+an..30
241	Customer part number	n3+an..30
242	Made-to-Order Variation Number	n3+n..6
250	Secondary Serial Number	n3+an..30
251	Reference to source entity	n3+an..30
253	Global Document Type Identifier (GDTI)	n3+n13+n..17
254	GLN Extension Component	n3+an..20
30	Quantity	n2+n..8
310 (***)	Net Weight, Kilograms	n4+n6
311 (***)	Length or 1st Dimension, Meters	n4+n6
312 (***)	Width, Diameter or 2nd Dimension, Meters	n4+n6
313 (***)	Depth, Thickness, Height or 3rd Dimension, Meters	n4+n6
314 (***)	Area, Square Meters	n4+n6
315 (***)	Volume, Liters	n4+n6
316 (***)	Volume, Cubic Meters	n4+n6

Table 22 UCC/EAN-128 Application Identifiers

Application Identifier (AI)	Content	Format
320 (***)	Net Weight, Pounds	n4+n6
321 (***)	Length Or 1st Dimension, Inches	n4+n6
322 (***)	Length Or 1st Dimension, Feet	n4+n6
323 (***)	Length Or 1st Dimension, Yards	n4+n6
324 (***)	Width, Diameter, or 2nd Dimension, Inches	n4+n6
325 (***)	Width, Diameter, or 2nd Dimension, Feet	n4+n6
326 (***)	Width, Diameter, or 2nd Dimension, Yards	n4+n6
327 (***)	Depth, Thickness, Height, or 3rd Dimension, Inches	n4+n6
328 (***)	Depth, Thickness, Height, or 3rd Dimension, Feet	n4+n6
329 (***)	Depth, Thickness, Height, or 3rd Dimension, Yards	n4+n6
330 (***)	Gross Weight-Kilograms	n4+n6
331 (***)	Length or 1st Dimension, Logistics	n4+n6
332 (***)	Width, Diameter, or 2nd Dimension, Meters, Logistics	n4+n6
333 (***)	Depth, Thickness, Height or 3rd Dimension, Meters, Logistics	n4+n6
334 (***)	Area, Square Meters, Logistics	n4+n6
335 (***)	Gross Volume, Liters	n4+n6
336 (***)	Gross Volume, Cubic Meters	n4+n6
337 (***)	Kilograms Per Square Meter	n4+n6
340 (***)	Gross Weight, Pounds	n4+n6
341 (***)	Length Or 1st Dimension, Inches, Logistics	n4+n6
342 (***)	Length Or 1st Dimension, Feet, Logistics	n4+n6
343 (***)	Length Or 1st Dimension, Yards, Logistics	n4+n6
344 (***)	Width, Diameter, or 2nd Dimension, Inches, Logistics	n4+n6
345 (***)	Width, Diameter, or 2nd Dimension, Feet, Logistics	n4+n6
346 (***)	Width, Diameter, or 2nd Dimension, Yards, Logistics	n4+n6
347 (***)	Depth, Thickness, Height or 3rd Dimension, Inches, Logistics	n4+n6
348 (***)	Depth, Thickness, Height or 3rd Dimension, Feet, Logistics	n4+n6
349 (***)	Depth, Thickness, Height or 3rd Dimension, Yards, Logistics	n4+n6
350 (***)	Area, Square Inches	n4+n6
351 (***)	Area, Square Feet	n4+n6
352 (***)	Area, Square Yards	n4+n6
353 (***)	Area, Square Inches, Logistics	n4+n6
354 (***)	Area, Square Feet, Logistics	n4+n6
355 (***)	Area, Square Yards, Logistics	n4+n6

Table 22 UCC/EAN-128 Application Identifiers

Application Identifier (AI)	Content	Format
356 (***)	Net Weight, Troy Ounce	n4+n6
357 (***)	Net Volume, Ounces	n4+n6
360 (***)	Volume, Quarts	n4+n6
361 (***)	Volume, Gallons	n4+n6
362 (***)	Gross Volume, Quarts	n4+n6
363 (***)	Gross Volume, Gallons	n4+n6
364 (***)	Volume, Cubic Inches	n4+n6
365 (***)	Volume, Cubic Feet	n4+n6
366 (***)	Volume, Cubic Yards	n4+n6
367 (***)	Gross Volume, Cubic Inches	n4+n6
368 (***)	Gross Volume, Cubic Inches	n4+n6
369 (***)	Gross Volume, Cubic Inches	n4+n6
390 (n)	Amount payable-single monetary area	n4+n..15
391 (n)	Amount payable with ISO currency code	n4+n3+n..15
392 (n)	Amount payable for a Variable Measure Trade Item single monetary unit	n4+n..15
393 (n)	Amount payable for a Variable Measure Trade Item - with ISO currency code	n4+n3+n..15
400	Customer's Purchase Order Number	n3+an..30
401	Consignment Number	n3+an..30
402	Shipment Identification Number	N3+n17
403	Routing code	N3+an..30
410	Ship To (Deliver To) Location Code Using EAN-13	n3+n13
411	Bill To (Invoice To) Location Code Using EAN-13	n3+n13
412	Purchase From (Location Code of Party From Whom Goods Are Purchased)	n3+n13
413	Ship For UCC/EAN Location Code	n3+n13
414	EAN Location Code For Physical Identification	n3+n13
415	EAN.UCC Global Location Number of the invoicing party	n3+n13
420	Ship To (Deliver To) Postal Code Within a Single Postal Authority	n3+an..20
421	Ship To (Deliver To) Postal Code With 3-Digit ISO Country Code Prefix	n3+n3+an..9
422	Country of origin of a trade item	n3+n3
423	Country of initial processing	N3+n3+n..12
424	Country of processing	n3+n3

Table 22 UCC/EAN-128 Application Identifiers

Application Identifier (AI)	Content	Format
425	Country of disassembly	n3+n3
426	Country covering full process chain	N3+n3
703(s)****	Approval number of processor with ISO country code	n4+n3+an..27
7001	NATO stock number	n4+n13
7002	UN/ECE meat carcasses and cuts classification	n4+an..30
7003	Expiration Date and Time	n4+n10
8001	Roll Products-Width, Length, Core Diameter, Direction and Splices	n4+n14
8002	Electronic serial identifier for cellular mobile telephones	n4+an..20
8003	UPC/EAN Number and Serial Number Or Returnable Asset	n4+n14+an..16
8004	UCC/EAN Serial Identification	n4+an..30
8005	Identifies the Price Per Unit of Measure	n4+n6
8006	Component of an Article	n4+n14+n2+n2
8007	International Bank Account Number	n4+an..30
8008	Date and time of production	n4+n8+n..4
8018	Service Relation Number	n4+n18
8020	Payment Slip Reference Number	n4+an..25
8100	Coupon Extended Code-Number System Character and Offer	n4+n1+n5
8101	Coupon Extended Code-Number System Character, Offer and End of Offer	n4+n1+n5+n4
8102	Coupon Extended Code-Number System Character Preceded by Zero	n4+n1+n1
8110	Coupon Code Identification for Use in North America	n4+an..30
90	Mutually Agreed, Between Trading Partners	n2+an..30
91	Intra-Company (Internal)	n2+an..30
92	Intra-Company (Internal)	n2+an..30
93	Intra-Company (Internal)	n2+an..30
94	Intra-Company (Internal)	n2+an..30
95	Internal-Carriers	n2+an..30
96	Internal-Carriers	n2+an..30
97	Intra-Company (Internal)	n2+an..30
98	Intra-Company (Internal)	n2+an..30
99	Internal	n2+an..30

(*) To indicate only year and month, DD must be filled with "00"

(**) Plus one digit for length indication

(***) Plus one digit for decimal point indication

(****) The fourth digit of this AI, "s," indicates the sequence of the processors in the supply chain.

Data Value Representation:

a - alphabetic characters	n - numeric characters
an - alpha-numeric characters	n3 - 3 numeric characters, fixed length
an..3 - up to 3 alpha-numeric characters	n..3 - up to 3 numeric characters

Quiet Zone

Both ends of the bar code structure require blank quiet zones. The quiet zones must be at least 0.25 inches wide and completely blank to ensure accurate reading of the start/stop codes and to prevent adjacent bar codes from overlapping. You must provide sufficient space on the form for the quiet zones.

Start/Stop Codes

The start and stop codes identify the leading and trailing ends of the bar code. UCC/EAN-128 uses unique start codes for character subsets B and C, and a stop code common to both. An automatic mode switching feature is used to generate the correct start code based on the first four data field characters.

Data Field

UCC/EAN-128 bar codes require a special character called "Function 1" (FNC1) to immediately follow the start code. IGP automatically supplies this character, so it must not be included in the data field by the user.

A character is made up of three bars and three spaces, each varying in width from 1 through 4 modules, for a total of eleven modules. The number of modules making up the bars is even. The stop code has four bars and is 13 modules wide.

The character set for UCC/EAN-128 is the same as the character set for Code 128. Every character is interpreted according to the currently active character subset. UCC/EAN-128 uses subset B and subset C only. Subset B, shown in Table 19 (page 136), includes all standard alphanumeric keyboard characters, lowercase alphabetical characters, and special characters. Subset C interprets the characters as pairs of numbers 00 through 99, along with some special characters, as shown in Table 20 (page 137). The start code or subset switch code determines whether a particular bar code character is decoded as one character or as a pair of numbers.

Readable Data

The optional printed data field (PDF) provides a human-readable interpretation of the bar code data. When the printed data field is enabled by use of the "PDF" parameter, the overall height of the bars is reduced to make room for a guard band and the human-readable characters. The printed data field will be formatted with spaces or parentheses denoting particular data fields such as the application identifier. Special characters such as start, stop, subset switch, modulo-103 check digit, and FNC1 do not appear in the human-readable data.

The readable data is oriented along the bar code from start code to stop code. It may be positioned above or below a bar code, and the bar code may be horizontal, vertical, or inverted.

Modulo-103 Check Digit

A modulo-103 check digit is automatically calculated and inserted in the bar code symbol immediately in front of the stop code, in the same manner as the Code 128 bar code. The check digit verifies accurate scanning. The start code is included in the check digit algorithm. The modulo-103 check digit is not displayed in the readable data field.

Modulo-10 Data Field Check Digit for SSCC-18 and SCC-14

AI 00 (called the Serial Shipping Container Code, or SSCC-18) takes eighteen additional numerical data bytes. The last data byte is a modulo-10 check digit on the preceding seventeen data bytes. Counting the two zeros of the application identifier, the modulo-10 check digit is the twentieth byte in the data field.

AI 01 (called the Shipping Container Code, or SCC-14) takes fourteen additional numerical data bytes. The last data byte is a modulo-10 check digit on the preceding thirteen data bytes. Counting the zero and the one of the application identifier, the modulo-10 check digit is the sixteenth byte in the data field.

The modulo-10 data field check digit for both SSCC-18 and SCC-14 is printed in the bar code as the second half of the last number pair using subset C. It is displayed in the human-readable data field as the twentieth byte for SSCC-18 or the sixteenth byte for SCC-14.

IGP automatically calculates the modulo-10 check digit for SSCC-18 if only 17 data digits are provided following the application identifier of 00. This is also true for SSCC-14 if only 15 digits are supplied. For concatenated barcodes, an FNC1 must be inserted for the checkdigit character so that PGL will calculate it.

GS1-128 Command Format

BARCODE

UCC-128; [DIR;] [MAG;] [Hn[.m];] [BFn;L;] [DARK;] SR;SC

(D)data field(D)

[PDF [;LOC] [;FONT]]

STOP

BARCODE	The Bar Code command; enter BARCODE .
UCC-128	Designates bar code type Code UCC-128; enter UCC-128 .
DIR	Optional parameter that allows for rotating a barcode. Enter CW for clockwise rotation. Enter CCW or VSCAN for counter-clockwise rotation. Enter INV for inverted rotation. If <i>DIR</i> is not entered, the barcode is horizontally oriented.
MAG	Optional parameter to magnify the bar code symbol by increasing the width of the bars and spaces. The magnification default value is X1 . Increasing the magnification adjusts printed character density as shown in Table 12, page 106 or Table 13, page 107, depending on your printers tip size. You can also use XR or XRD as defined on page 104.

NOTE: A valid UCC/EAN-128 bar code can be no larger than 165 mm (6.5 inches) wide.

NOTE: There are eight values that comprise the dot ratio: narrow bar, narrow space, 2x narrow bar, 2x narrow space, 3x narrow bar, 3x narrow space, 4x narrow bar, and 4x narrow space. User-defined ratios for this barcode should have these eight values defined in the order specified.

Hn[.m]	Optional parameter to adjust the overall height of the bar code symbol (including the upper and lower 0.1 inch guard bands and any human-readable data). Height adjustments are made in 0.1 inch increments; enter H and a value from 3 through 99 to select height adjustments from 0.3 through 9.9 inches. The default value is 0.9 inch. [.m] is an additional number of dots for the bar code height. (Dots are in the current scale).
--------	---

NOTE: If 0.3 inches is the selected height, the PDF cannot be included.

BFn;L	Optional parameters for assigning a dynamic bar code data field location on a form and for designating the length of the data field. With these parameters, the actual data for the bar code data field is dynamically provided during the Execute Form Mode; the data is not specified during the Create Form Mode. To use this field, perform the following steps:
-------	--

- a. Enter **BF**.
- b. Replace n with a number ranging from **0 through 512** to identify the bar code field. The *SR* and *SC* parameters specify the exact location of the bar code field identified by n .
- c. Replace L with the maximum number of characters in the field. The actual data provided dynamically during the Execute Form Mode can be less than L . It is permitted to supply no data at all.
- d. The information for the data field is entered dynamically during the Execute Form Mode. (Refer to Execute Form: Dynamic Bar Code Data on page 62.) Do not use the *data field* parameter to enter data when the $BFn;L$ parameters are used. However, refer to the *data field* description for available characters to use during Execute Form Mode.

DARK	Optional parameter to produce darker looking bar codes. Enter DARK . Refer to Dark Printing on page 52 for more information.
<i>SR</i>	Defines the starting row for the bar code. Enter a value ranging from row 1 to one less than the length of the form. Character row or dot row is specified based on the Scale command, or use the CP.DP format.
<i>SC</i>	Defines the starting column of the bar code. Enter a value ranging from column 1 to one less than the width of the form. Character column or dot column is specified based on the Scale command, or use the CP.DP format.
(<i>D</i>)	The printable character (delimiter) identifying the start and finish of the data field. Enter any printable character other than a slash (/), the SFCC, or a character used within the data. The same character must be used on both ends of the data field. It will not print with the data.
<i>data field</i>	<p>The bar code data. The data field for UCC/EAN- 128 consists of an “application identifier” (AI) of two to four numbers, followed by data of appropriate length (variable or fixed) and type (numeric or alphanumeric). See Table 22 for a list of application identifiers and their associated data fields.</p> <p>The FNC1 character is required as the first character after the start code for UCC/EAN-128 bar codes, and IGP will always generate it automatically. It will appear in the bar code but not in the human-readable field. Do not supply FNC1 in the data field.</p> <p>The start code and subset switching is done automatically by IGP based on the data field contents so that the bar code length is minimized. Subset C encodes each pair of numbers as a single bar code character, providing a higher character density. If the first four data digits are numbers, the bar code starts in subset C; otherwise it starts in subset B. The subset will switch from B to C at any point in the data field if the next four characters are numbers, and will switch from C to B if the next two characters are not numbers or only one character remains.</p> <p>The data field can contain any of the characters listed in Table 22 except the system SFCC and the character used as a delimiter.</p>
PDF	Optional parameter to enable printing of the human readable data field. Enter PDF to print the data field. If this parameter is not used, the human readable data will not print.

LOC Optional parameter to identify the location of the printable data field. The default value is **B**, locating the human readable data below the bar code. **A** locates the printable data field above the bar code. The height of the bar code body is reduced to compensate for the human readable field and the guard bands.

FONT Optional parameter to select the font for the human readable data field. Enter **O** to select OCR-A font; enter **X** to select OCR-B font; enter **N** to select 10 cpi; enter **P** to select 12 cpi; enter **Q** to select 13 cpi; enter **R** to select 15 cpi; enter **T** to select 17 cpi; enter **V** to select 20 cpi.

To select a scalable font with user-defined size, enter **Nh:w** or **F;Nh:w**. The parameters h (height) and w (width) can each range from 1 to 96, and are expansion factors of a 10 cpi character. Nh:w prints in Letter Gothic (font 93779) regardless of the current active font. By default F;Nh:w uses the Letter Gothic as the current font selection. You can change the default by using the FONT command.

NOTE: Nh:w and F;Nh:w will not print the PDF wider or taller than the barcode. If the height parameter h causes the PDF to print above the horizontal barcode start row or vertical barcode start column, a barcode font Error will occur. If the width parameter w causes the PDF to exceed the barcode width, the PDF width factor w will automatically reduce to fit within the barcode width without causing an error.

STOP Ends the bar code command while the IGP continues in the Create Form Mode. Enter **STOP**. If STOP is not encountered, an error message results.

Code UCC/EAN-128 Examples

The following example generates the SSCC-18 variant of a UCC/EAN-128 bar code in horizontal orientation at the default ratio, and vertically at a user defined ratio of double normal size.

NOTE: The fields of AI=00 are seen here separated by spaces. By default, the AI is separated from the rest of the data by parenthesis. This is controlled by the front panel option "AI 00 Spaces" in the IGP menu (see your *Administrator's Guide*).

```
~CREATE;UCCTEST
/ Horizontal bar code is dark, nominal width, start row 35, start column 15.
/ Human-readable field is below the bar code in OCR-B font. BARCODE
UCC-128;DARK;35;15
*0034567890123456789*
PDF;X
STOP
/ Vertical bar code is dark, double width, start row 35, start column 50.
/ Human-readable data field is above the bar code in normal 10 cpi font.
BARCODE
UCC-128;VSCAN;XR2:2:4:4:6:6:8:8;H12;DARK;35;50
*0034567890123456789*
PDF;A
STOP
END
~EXECUTE;UCCTEST
~NORMAL
```



Figure 24 UCC/EAN-128 Example 1

The program below illustrates incremental UCC/EAN-128 barcodes. Incremental UCC/EAN-128 barcode syntax for non-impact printers requires that the STARTMASK be exactly as wide as the data field.

```
~CREATE;UCCINC;140
BARCODE
UCC-128;I;DARK;3;20
+XXXXXXXXXX00001;*400P0119600001*
PDF;B
STOP
ALPHA
DARK;1;20;0;0;*PURCHASE ORDER NUMBER*
STOP
END
~EXECUTE;UCCINC;3
~NORMAL
```

PURCHASE ORDER NUMBER



(400)PO119600001

PURCHASE ORDER NUMBER



(400)PO119600002

PURCHASE ORDER NUMBER



(400)PO119600003

Figure 25 UCC/EAN-128 Example 2

The following example shows the use of dynamic data. The ship-to-postal code, AI 420, is used to encode 5 digit ZIP Codes.

```
~CREATE;UCCDYN;140  
BARCODE  
UCC-128;BF1;8;3;20  
PDF;X  
STOP  
ALPHA  
DARK;1;20;0;0;*SHIP TO POSTAL*  
STOP  
END  
~EXECUTE;UCCDYN  
~BF1;*42092614*  
  
~NORMAL  
~EXECUTE;UCCDYN  
~BF1;*42090210*  
  
~NORMAL  
~EXECUTE;UCCDYN  
~BF1;*42090028*  
  
~NORMAL
```

SHIP TO POSTAL



(420)92614

SHIP TO POSTAL



(420)90210

SHIP TO POSTAL



(420)90028

Figure 26 UCC/EAN-128 Example 3

GS1 Datamatrix

NOTE: GS1 Datamatrix is formerly known as Datamatrix.

Datamatrix is a two-dimensional barcode containing small dark and light square data modules. It has a finder pattern of two solid lines and two alternating dark and light lines on its perimeter. This barcode is capable of storing up to 3116 numeric digits, 2335 alphanumeric in a symbol 144 modules square. It is also capable of encoding in a number of different schemes.

Two main subsets for Datamatrix exist, which differ in terms of error correction. The first subset uses ECC-000 through ECC-140 and uses convolution coding for error correction. The second subset is ECC-200, which uses Reed-Solomon error correction techniques. ECC-200 format is recommended.

Quiet Zone

The minimum quiet zone is one module width on all four sides.

Readable Data

There is no printable data field allowed for the Datamatrix barcode.

Data Field

The data allowed within the data field depends on the error correction subset you are using. See the *data field* description on page 171 for details.

Data Matrix Command Format

BARCODE

DATAMATRIX; [*DIR*]; [*X*[*D*]*n*]; [*Y*[*D*]*n*]; [*Cn*]; [*Rn*]; [*ECCn*]; [*IDn*]; [*BFn*; *L*]; [*DARK*];

SR; *SC (D)data field(D)*

STOP

BARCODE The Bar Code command; enter **BARCODE**.

DATAMATRIX Designates bar code type Data Matrix; enter **DATAMATRIX**.

DIR Optional parameter that allows for rotating a barcode. Enter **CW** for clockwise rotation. Enter **CCW** or **VSCAN** for counter-clockwise rotation. Enter **INV** for inverted rotation. If *DIR* is not entered, the barcode is horizontally oriented.

X[*D*]*n* Optional parameter designating the x-dimension width of a single square data module in IGP dots, or printer dots if the **D** option is used. Enter **X**, then the optional **D** parameter if necessary, then a value from **1** through **1000** printer dots. If the y-dimension is not specified, it is calculated by converting the printer dots in the x-direction to printer dots in the y-direction.

Y[*D*]*n* Optional parameter designating the y-dimension width of a single square data module in IGP dots, or printer dots if the **D** option is used. Enter **Y**, then the optional **D** parameter if necessary, then a value from **1** to **1000** printer dots. If the x-dimension is not specified, it is calculated by converting the printer dots in the y-direction to printer dots in the x-direction.

Cn Optional parameter that sets the number of columns in the symbol. A value of **0** (the default) automates this process. See Table 26 through Table 32 for the combination of columns and rows allowed and the maximum amount of data that can be encoded.

<i>Rn</i>	Optional parameter that specifies the number of rows in the symbol. A value of 0 (the default) automates this process. See Table 26 through Table 32 for the combination of columns and rows allowed and the maximum amount of data that can be encoded.
<i>ECCn</i>	Optional parameter that specifies the error correction level. Enter ECC , then one of the following values: 0, 50, 80, 100, 140, or 200 . Levels 0 through 140 use increasing levels of convolutional error coding. Level 200 (the default) uses Reed-Solomon block error correction and is the recommended level of error correction.
<i>IDn</i>	Optional parameter that specifies the format ID. This field only has meaning for ECC-000 through ECC-140 and is ignored for ECC-200. This specifies the type of data that is encoded in the symbol. Enter ID , then a value from 1 through 6 . The default value is 3. Table 23 shows the type of data encoded for the various format IDs.
<i>BFn;L</i>	Optional parameters for assigning a dynamic bar code data field location on a form and for designating the length of the data field. With these parameters, the actual data for the bar code data field is dynamically provided during the Execute Form Mode; the data is not specified during the Create Form Mode. To use this field, perform the following steps: <ol style="list-style-type: none"> Enter BF. Replace <i>n</i> with a number ranging from 0 through 512 to identify the bar code field. The <i>SR</i> and <i>SC</i> parameters specify the exact location of the bar code field identified by <i>n</i>. Replace <i>L</i> with a number equaling the total number of characters in the field. (The actual data provided dynamically during the Execute Form Mode can be less than <i>L</i>.) The information for the data field is entered dynamically during the Execute Form Mode. (Refer to Execute Form: Dynamic Bar Code Data on page 62.) Do not use the <i>data field</i> parameter to enter data when the <i>BFn;L</i> parameters are used. However, refer to the <i>data field</i> description for available characters.
DARK	Optional parameter to produce darker looking bar codes. Enter DARK . Refer to Dark Printing on page 52 for more information.
<i>SR</i>	Defines the starting row for the bar code. Enter a value ranging from row 1 to one less than the length of the form. Character row or dot row is specified based on the Scale command (page 95), or use the CP.DP format (page 24).
<i>SC</i>	Defines the starting column of the bar code. Enter a value ranging from column 1 to one less than the width of the form. Character column or dot column is specified based on the Scale command (page 95), or use the CP.DP format (page 24).
<i>(D)</i>	The printable character (delimiter) identifying the start and finish of the data field. Enter any printable character other than a slash (/), the SFCC, or a character used within the data. The same character must be used at both ends of the data field, but it will not print with the data.
<i>data field</i>	For ECC-000 through ECC-140, the data allowed within the data field depends on the format ID parameter. The allowed data for these ECC types are given in Table 23. For Format ID #5 which accepts control characters and Format ID #6 which accepts codes greater than 127, you can enter these values using a SO character followed by an identifier. When encoding special characters, you must enter a SO character

followed by at least one other identifier and its field (i.e., ASCII 254 = ^d254). This is only considered to be one character, even though the data field holds 5 characters (^d254). If you intend to code the SO character by itself (no special encoding), then the SO character should be followed by another SO character. Table 24 illustrates how to use these special characters.

Table 23 Data Field for ECC-000 through ECC-140

Format ID #	Data
1	Numeric 0-9, Space
2	Uppercase A-Z, Space
3	Uppercase A-Z, Numeric 0-9, Space
4	Uppercase A-Z, Numeric 0-9, Space, Period, Comma, Minus, Forward Slash
5	Full 128 ASCII set (0-127)
6	User defined (0-255)

For ECC-200, format ID has no meaning and is ignored. Instead, you can enter data of any type (ASCII 0-255) and it will be automatically optimized into the proper encoding scheme. See the Special Characters Using SO section for examples of methods to enter special characters such as FNC1 into the data stream.

The maximum number of data depend on three factors: (1) size of the matrix, (2) ECC level, and (3) type of data. The size of the matrix is automatically chosen by IGP unless the parameters of row and/or column are supplied (see *Cn* and *Rn* parameters). The maximum number of data can then be found by finding the proper table based on ECC type. For each different valid matrix combination, the maximum number of data are given for numeric, alphanumeric, and full 8-byte data. You do not have to enter the maximum: a pad character is automatically inserted into the barcode when necessary.

STOP Ends the Bar Code command while the IGP continues in the Create Form Mode. Enter **STOP**. If STOP is not entered, an error message results.

NOTE: Line Matrix printers produce less square modules for small module dimensions because of its non-square resolution. However, when properly selecting the X and Y module dimensions for a specific resolution, the resulting barcode is reliably and consistently read by 2D barcode readers.

Special Characters Using SO

Table 24 and Table 25 illustrate the methods of encoding special characters, and shows the special characters supported. These special characters are identified by using SO. The default value for the SO character is hex 0E, but this value can be changed using the printer's front panel (see *Administrator's Guide* for details). Examples are given with the SO character represented by “^” for clarity.

Table 24 Special Character Encoding (All ECC Levels)

Special Characters	Method	Example
Control Characters 0-31	<SO> + @ ... <SO> + _	NUL = ^@, BEL = ^G
Any ASCII value 0 - 255	<SO> + d + 3 digit	ASCII 10 = ^d010
ASCII value SO	<SO> + <SO>	^^

Table 25 Special Character Encoding (ECC-200 Only)

Special Characters	Method	Example
FNC1	<SO> + 1. If FNC1 is 2nd codeword, previous data must be A-Z, a-z, or 01-99	01^1<Data>
Structured Append	<SO> + 2 + 3 digit number representing symbol sequence and file identifier	^2042<File ID>
Reader Programming	<SO> + 3 Must be first in the data field	^3<Data>
MH10.8.3 Abbreviated Format 05 Header	<SO> + 5 Must be first in the data field	^5<Data>
MH10.8.3 Abbreviated Format 06 Header	<SO> + 6 Must be first in the data field	^6<Data>
Extended Channel Interpretation	<SO> + 7 + 6 digit EC (000000-999999)	^7112233<Data>

Symbol Characteristics

The following tables illustrate the maximum data capacities for the Data Matrix barcode as a function of symbol size (column x row) and data type. Note that all ECC-000 through ECC-140 symbols are square and always have an odd number of rows and columns. ECC-200 symbols have square or rectangular sizes and have an even number of rows and columns.

Table 26 ECC-000 Characteristics

(Row x Column)	Maximum Numeric	Maximum Alphanumeric	Maximum 8-Byte Data
9 X 9	3 characters	2 characters	1 character
11 X 11	12 characters	8 characters	5 characters
13 X 13	24 characters	16 characters	10 characters
15 X 15	37 characters	25 characters	16 characters
17 X 17	53 characters	35 characters	23 characters
19 X 19	72 characters	48 characters	31 characters
21 X 21	92 characters	61 characters	40 characters
23 X 23	115 characters	76 characters	50 characters
25 X 25	140 characters	93 characters	61 characters
27 X 27	168 characters	112 characters	73 characters
29 X 29	197 characters	131 characters	86 characters
31 X 31	229 characters	153 characters	100 characters
33 X 33	264 characters	176 characters	115 characters
35 X 35	300 characters	200 characters	131 characters
37 X 37	339 characters	226 characters	148 characters
39 X 39	380 characters	253 characters	166 characters
41 X 41	424 characters	282 characters	185 characters
43 X 43	469 characters	313 characters	205 characters
45 X 45	500 characters	345 characters	226 characters
47 X 47	560 characters	378 characters	248 characters
49 X 49	596 characters	413 characters	271 characters

Table 27 ECC-050 Characteristics

(Row x Column)	Maximum Numeric	Maximum Alphanumeric	Maximum 8-Byte Data
11 X 11	1 character	1 character	not supported
13 X 13	10 characters	6 characters	4 characters
15 X 15	20 characters	13 characters	9 characters
17 X 17	32 characters	21 characters	14 characters
19 X 19	46 characters	30 characters	20 characters
21 X 21	61 characters	41 characters	27 characters
23 X 23	78 characters	52 characters	34 characters
25 X 25	97 characters	65 characters	42 characters
27 X 27	118 characters	78 characters	51 characters
29 X 29	140 characters	93 characters	61 characters
31 X 31	164 characters	109 characters	72 characters
33 X 33	190 characters	126 characters	83 characters
35 X 35	217 characters	145 characters	95 characters
37 X 37	246 characters	164 characters	108 characters
39 X 39	277 characters	185 characters	121 characters
41 X 41	310 characters	206 characters	135 characters

Table 27 ECC-050 Characteristics

(Row x Column)	Maximum Numeric	Maximum Alphanumeric	Maximum 8-Byte Data
43 X 43	344 characters	229 characters	150 characters
45 X 45	380 characters	253 characters	166 characters
47 X 47	418 characters	278 characters	183 characters
49 X 49	457 characters	305 characters	200 characters

Table 28 ECC-080 Characteristics

(Row x Column)	Maximum Numeric	Maximum Alphanumeric	Maximum 8-Byte Data
13 X 13	4 characters	3 characters	2 characters
15 X 15	13 characters	9 characters	6 characters
17 X 17	24 characters	16 characters	10 characters
19 X 19	36 characters	24 characters	16 characters
21 X 21	50 characters	33 characters	22 characters
23 X 23	65 characters	43 characters	28 characters
25 X 25	82 characters	54 characters	36 characters
27 X 27	100 characters	67 characters	44 characters
29 X 29	120 characters	80 characters	52 characters
31 X 31	141 characters	94 characters	62 characters
33 X 33	164 characters	109 characters	72 characters
35 X 35	188 characters	125 characters	82 characters
37 X 37	214 characters	143 characters	94 characters
39 X 39	242 characters	161 characters	106 characters
41 X 41	270 characters	180 characters	118 characters
43 X 43	301 characters	201 characters	132 characters
45 X 45	333 characters	222 characters	146 characters
47 X 47	366 characters	244 characters	160 characters
49 X 49	402 characters	268 characters	176 characters

Table 29 ECC-100 Characteristics

(Row x Column)	Maximum Numeric	Maximum Alphanumeric	Maximum 8-Byte Data
13 X 13	1 character	1 character	not supported
15 X 15	8 characters	5 characters	3 characters
17 X 17	16 characters	11 characters	7 characters
19 X 19	25 characters	17 characters	11 characters
21 X 21	36 characters	24 characters	15 characters
23 X 23	47 characters	31 characters	20 characters
25 X 25	60 characters	40 characters	26 characters
27 X 27	73 characters	49 characters	32 characters
29 X 29	88 characters	59 characters	38 characters
31 X 31	104 characters	69 characters	62 characters
33 X 33	121 characters	81 characters	53 characters
35 X 35	140 characters	93 characters	61 characters
37 X 37	159 characters	106 characters	69 characters
39 X 39	180 characters	120 characters	78 characters
41 X 41	201 characters	134 characters	88 characters
43 X 43	224 characters	149 characters	98 characters
45 X 45	248 characters	165 characters	108 characters
47 X 47	273 characters	182 characters	119 characters
49 X 49	300 characters	200 characters	131 characters

Table 30 ECC-140 Characteristics

(Row x Column)	Maximum Numeric	Maximum Alphanumeric	Maximum 8-Byte Data
17 X 17	2 characters	1 character	1 character
19 X 19	6 characters	4 characters	3 characters
21 X 21	12 characters	8 characters	5 characters
23 X 23	17 characters	11 characters	7 characters
25 X 25	24 characters	16 characters	10 characters
27 X 27	30 characters	20 characters	13 characters
29 X 29	38 characters	25 characters	16 characters
31 X 31	46 characters	30 characters	20 characters
33 X 33	54 characters	36 characters	24 characters
35 X 35	64 characters	42 characters	28 characters
37 X 37	73 characters	49 characters	32 characters
39 X 39	84 characters	56 characters	36 characters
41 X 41	94 characters	63 characters	41 characters
43 X 43	106 characters	70 characters	46 characters
45 X 45	118 characters	78 characters	51 characters
47 X 47	130 characters	87 characters	57 characters
49 X 49	144 characters	96 characters	63 characters

Table 31 ECC-200 Square Characteristics

(Row x Column)	Maximum Numeric	Maximum Alphanumeric	Maximum 8-Byte Data
10 X 10	6 characters	3 characters	1 character
12 X 12	10 characters	6 characters	3 characters
14 X 14	16 characters	10 characters	6 characters
16 X 16	24 characters	16 characters	10 characters
18 X 18	36 characters	25 characters	16 characters
20 X 20	44 characters	31 characters	20 characters
22 X 22	60 characters	43 characters	28 characters
24 X 24	72 characters	52 characters	34 characters
26 X 26	88 characters	64 characters	42 characters
32 X 32	124 characters	91 characters	60 characters
36 X 36	172 characters	127 characters	84 characters
40 X 40	228 characters	169 characters	112 characters
44 X 44	288 characters	214 characters	142 characters
48 X 48	348 characters	259 characters	172 characters
52 X 52	408 characters	304 characters	202 characters
64 X 64	560 characters	418 characters	278 characters
72 X 72	736 characters	550 characters	366 characters
80 X 80	912 characters	682 characters	454 characters
88 X 88	1152 characters	862 characters	574 characters
96 X 96	1392 characters	1042 characters	694 characters
104 X 104	1632 characters	1222 characters	814 characters
120 X 120	2100 characters	1573 characters	1048 characters
132 X 132	2608 characters	1954 characters	1302 characters
144 X 144	3116 characters	2335 characters	1556 characters

Table 32 ECC-200 Rectangular Characteristics

(Row x Column)	Maximum Numeric	Maximum Alphanumeric	Maximum 8-Byte Data
8 X 18	10 characters	6 characters	3 characters
8 X 32	20 characters	13 characters	8 characters
12 X 26	32 characters	22 characters	14 characters
12 X 36	44 characters	31 characters	20 characters
16 X 36	64 characters	46 characters	30 characters
16 X 48	98 characters	72 characters	47 characters

Data Matrix Example

Figure 27 illustrates a Data Matrix bar code generated by the following program:

```
~CREATE;DATAMATRIX          (Enters Create Form mode)
BARCODE                     (Bar Code command)
DATAMATRIX;XD8;C18;R18;ECC200;ID5;10;10
                             (Data Matrix barcode, x-dimension
                             width of 8 printer dots, 18 columns
                             and 18 rows, Error Correction level
                             200, SR 10, SC 10)
*A1B2C3D4E5F6G7H8I9J0*   (Data Field)
STOP                         (Ends Bar Code command)
END                           (Terminates Create Form mode)
~EXECUTE;DATAMATRIX;1       (Execute the form, form count of 1)
~NORMAL
```

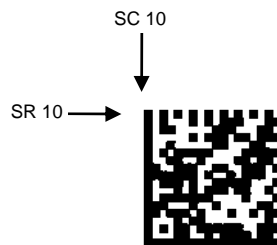

Figure 27 Data Matrix Example

HIBC Barcode

The Health Industry Business Communications (HIBC) has developed a barcode called HIBC (Health Industry Bar Code). In a global setting, HIBC identifies health industry products, in any quantity, of any lot or serial number, with any expiration date. HIBC represents two kinds of information: Primary and Secondary Identification. Primary Identification represents product identity and Secondary Identification represents the attributes of Lot or Batch Code, Serial Number, and Expiration date. Each structure has its own barcode data format. HIBC can be encoded in Code 128, Code 39, or UCC 128 symbology.

HIBC Barcode Command Format

```
BARCODE
C3/9 or C128A or C128B or C128C;HIBC:[DIR;][MAG]...
<Data Field>
PDF...
STOP
```

HIBC Enter **HIBC** to print HIBC encoded barcode.

Check Digit

A mandatory modulo-43 check digit is inserted at the end of data for both Code 39 and Code 128 symbology.

Data Field

The data field is a variable length consisting of only the following characters: 1-9, A-Z, -, ., &, /, +, %, and space.

For HIBC barcode, PDF is preceded with '+', a Flag Character which is an identifier used to differentiate HIBC symbols from other non-healthcare related barcode symbols. A pair of asterisks (*) encloses the human readable field, including the check digit. For example, if the user enters PDF "+123BJC5D6E71" the barcode data will print as "+A123BJC5D6E71G*".

HIBC Encoded in UCC128

When encoding HIBC barcode in UCC-128, HIBC is essentially a UCC-128 barcode. The encoding uses the same module 10 check digit and data format. The only addition is an Application Identifier (AI) parameter. For Primary Data Structure use AI (01), and for Secondary Data Structure use AI (22) or AI (240). To use UCC-128 to encode HIBC, be sure to use the correct AI parameter to obtain the desired results.

HIBC Barcode Example

```
~CREATE;XYZ;432
BARCODE
C128B;HIBC;X1;H10;5;5
"+A123BJC5D6E71"
PDF;B
STOP
BARCODE
C3/9;HIBC;X1;H10;15;5
"+A123BJC5D6E71"
PDF;B
STOP
END

HIBC BARCODES
~NORMAL
```

HIBC BARCODES



+A123BJC5D6E71G



+A123BJC5D6E71G

Figure 28 HIBC Barcodes

Intelligent Mail 4-State Barcode

Intelligent Mail 4-state is a barcode symbology, introduced by USPS to support the US Mail 4-state customer barcode. It is also known as the USPS OneCode Solution or USPS 4-State Customer Barcode. This barcode is identified by four different types of bars:

- **Full Height** - fixed height
- **Tracker** - a small center section
- **Ascender** - extends from the top of the Full Height limit to the bottom of the Tracker limit.
- **Descender** - extends from the top of the Tracker Limit to the bottom of the Full Height limit.

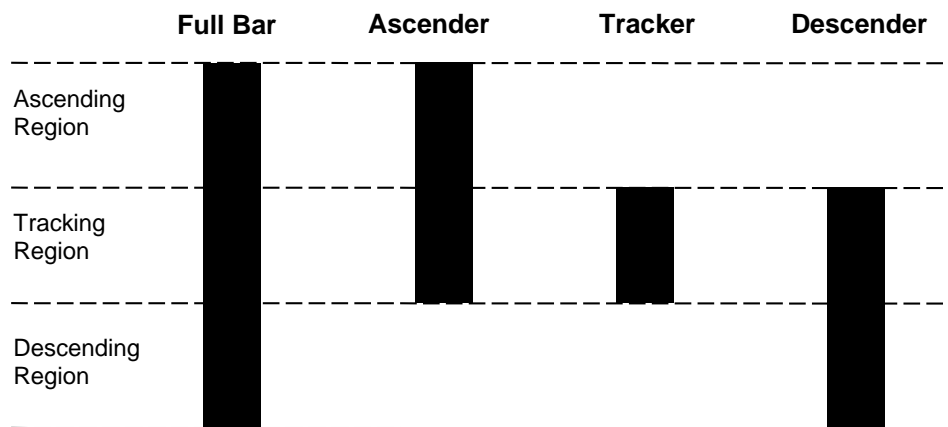

Figure 29 Intelligent Mail Barcode Bar Types

Customer Data must be in numeric format only. PDF is not allowed for Intelligent Mail Barcode.

Additional information regarding use of this barcode can be obtained from the USPS publication *Intelligent Mail Barcode Technical Resource Guide*.

Intelligent Mail 4-State Command Format

NOTE: Parameter names are italicized.

Square brackets enclose optional parameters; do not type the brackets.

Parenthesis enclose variable data; do not type the parenthesis. Other text is type as shown.

BARCODE

INTMAIL;*[DIR;]* *[NLQ;]* **[BF***n***;***L;* **[DARK;]** *SR;* *SC*

[(D)Data Field(D)]

STOP

<i>INTMAIL</i>	Intmail has a predefined magnification (width). The height of the Full Height bar is 0.145 inches with 0.020 inch margin and cannot be adjusted by the user. Human-readable data field is not allowed.
<i>DIR</i>	Optional parameter that allows for rotating a barcode. Enter CW for clockwise rotation. Enter CCW or VSCAN for counter-clockwise rotation. Enter INV for inverted rotation. If <i>DIR</i> is not entered, the barcode is horizontally oriented.

NLQ	Optional parameter optimized to print barcodes at NLQ print density (180x96). This may cause line matrix printers to reverse motion when the form prints. This parameter is ignored for other printer types.
BF <i>n</i> ;L	Optional parameters for assigning a dynamic bar code data field location on a form and for designating the length of the data field. With these parameters, the actual data for the barcode data field is dynamically provided during the Execute Form Mode; the data is not specified during the Create Form Mode. To use this field, perform the following steps: <ol style="list-style-type: none"> Enter BF. Replace <i>n</i> with a number ranging from 0 to 512 to identify the barcode field. The <i>SR</i> and <i>SC</i> parameters specify the exact location of the barcode field identified by <i>n</i>. Replace <i>L</i> with a number equal to the total number of characters in the field. The data field must be numeric and contain exactly 20, 25, 29, or 31 digits. An empty field is also allowed. The information for <i>Data Field</i> is entered dynamically during the Execute Form Mode. (Refer to Execute Form: Dynamic Bar Code Data on page 62.) Do not use <i>Data Field</i> to enter data when the <i>BFn;L</i> parameters are used. Refer to the <i>Data Field</i> description for available characters.
DARK	Optional parameter to produce darker looking bar codes. This has no affect on horizontally oriented barcodes. Enter DARK . Refer to Dark Printing on page 52 for more information.
SR	Defines the starting row for the barcode. Enter a value within the range of the 4-inch vertical address block. Character row or dot row is specified based on the Scale command (page 95), or use the CP.DP format (page 24).
SC	Defines the starting column of the barcode. Enter a value between the 1/2-inch left and right margins of the mail piece. Character column or dot column is specified based on the SCALE command (page 95), or use the CP.DP format (page 24).

(D) *Data Field* (D)

Delimiters (D) can be any character not present in the data field. The leading delimiter must be identical to the trailing delimiter. All *Data Field* characters are numeric.

Table 33 shows the valid parameters for the all the fields. The Tracking Code is 20 digits in length. The Routing Code is optional, but if it is included, it must be 5, 9 or 11 digits in length. The maximum total input data is 31 numeric digits. PGL encodes any length of input data into a 4-state customer barcode string consisting of 65 bars.

Table 33 Data Field Parameters

Type	Field	Digits
Tracking Code	Barcode Identifier	2 Second digit must be 0 - 4.
	Service Type Identifier	3
	Mailer Identifier	6 or 9
	Serial Number	9 when Mailer ID is 6 digits 6 when Mailer ID is 9 digits
Routing Code	Delivery Point Zip Code	0, 5, 9, 11
Total		20 minimum, 31 maximum

STOP Ends the Bar Code command while the IGP continues in the Create Form Mode. Enter **STOP**. If STOP is not entered, an error message will result.

Intelligent Mail 4-State Barcode Example

```
~CREATE ; INTELBARCODE ; 432
BARCODE
INTMAIL ; 5 ; 5
*01234567094987654321012345678*
STOP
END
```

```
~EXECUTE ; INTELBARCODE
```

```
~NORMAL
```



Interleaved 2/5 (I-2/5), German I-2/5, and ITF-14

The structure for the I-2/5, German I-2/5 and ITF-14 bar codes is shown in Figure 30 and described on the following pages.

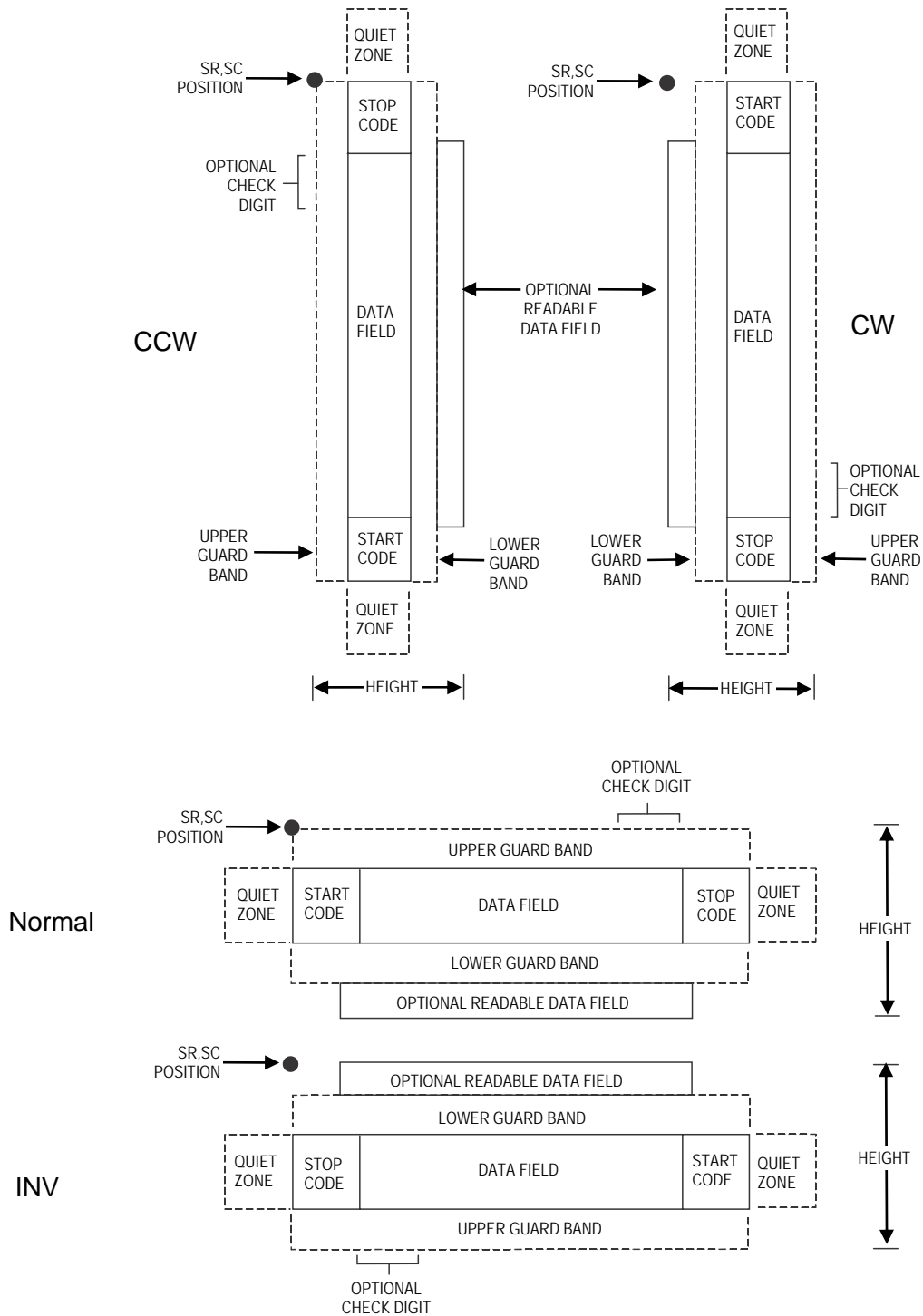

Figure 30 I-2/5, German I-2/5 and ITF-14 Structure

Quiet Zone

Both ends of the bar code structure have blank quiet zones. The quiet zones must be at least 0.25 inches wide and completely blank to ensure accurate reading of the start/stop codes and to prevent adjacent bar codes from overlapping. You must provide sufficient space on the form for the quiet zones.

Start/Stop Codes

Unique start and stop codes permit bidirectional scanning. Both start and stop codes contain bars and spaces. They are automatically produced.

Data Field

The bar code symbol uses a series of wide and narrow bars and spaces to represent numeric characters. The structure is 2 wide elements (bars or spaces) and 3 narrow elements. In the bar code, two characters are interleaved (paired); bars are used to represent the first character in the pair and spaces are used to represent the second character in the pair.

German I-2/5 and ITF-14 are special cases of Interleaved 2/5 bar codes. While Interleaved 2/5 has a variable data field, German I-2/5 is restricted to 11 or 13 digits, and ITF-14 is restricted to 13 digits.

Readable Data

The optional readable data field provides a readable interpretation of the bar code data. It can be printed above or below the bar code symbol.

Check Digit

The modulo-10 check digit can be inserted into the bar code to verify accurate scanning.

Interleaved 2/5 can be printed with or without a check digit, but German I-2/5 and ITF-14 have the check digit automatically included.

I-2/5, German I-2/5, and ITF-14 Command Format

BARCODE
I-2/5 [CD]; or
I25GERMAN; or
ITF14; [DIR;] [MAG;] [Hn[.m];] [BFn;L;] [DARK;] SR; SC
(D)data field(D)
[PDF [;LOC] [;FONT]]
STOP

BARCODE	The Bar Code command; enter BARCODE .
2/5 CD	Designates bar code type Interleaved 2/5; enter I-2/5 . To calculate and plot the optional modulo-10 check digit with the bar code symbol automatically, enter CD .
I25GERMAN	Designates German Interleaved 2/5; enter I25GERMAN . The mod-10 check digit is automatically included.
ITF14	Designates ITF-14; enter ITF14 . The mod-10 check digit is automatically included.
DIR	Optional parameter that allows for rotating a barcode. Enter CW for clockwise rotation. Enter CCW or VSCAN for counter-clockwise rotation. Enter INV for inverted rotation. If <i>DIR</i> is not entered, the barcode is horizontally oriented.
MAG	Optional parameter to magnify (horizontally expand) the bar code symbol. The magnification default value is X1 . As required for scanning, enter a magnification value from Table 12, page 106 or Table 13, page 107, depending on your printers tip size to increase the magnification.

Increasing the magnification adjusts printed character density. You can also use XR or XRD as defined on page 104.

NOTE: You must specify four digits for MAG for User Defined variable ratio. There are four values that comprise the dot ratio: narrow bar, narrow space, wide bar, and wide space. User-defined ratios for this barcode should have these four values defined in the order specified.

Hn[.m] Optional parameter to adjust the overall height (vertical expansion) of the bar code symbol (including the upper and lower 0.1-inch guard bands and any human readable data). Height adjustments are made in 0.1-inch increments; enter **H** and a value from **3** through **99** to select height adjustments from 0.3 through 9.9 inches. The default value is 0.9-inch. [.m] is an additional number of dots for the bar code height. (Dots are in the current dot scale.)

NOTE: If 0.3 inches is the selected height, the PDF cannot be included.

BFn;L Optional parameters for assigning a dynamic bar code data field location on a form and for designating the length of the data field. With these parameters, the actual data for the bar code data field is dynamically provided during the Execute Form Mode; the data is not specified during the Create Form Mode. To use this field, perform the following steps:

- a. Enter **BF**.
- b. Replace *n* with a number ranging from **0 through 512** to identify the bar code field. The *SR* and *SC* parameters specify the exact location of the bar code field identified by *n*.
- c. Replace *L* with a number equaling the total number of characters in the field. (The actual data provided dynamically during the Execute Form Mode can be less than *L*.)
- d. The information for the data field is entered dynamically during the Execute Form Mode. (Refer to Execute Form: Dynamic Bar Code Data on page 62.) Do not use the *data field* parameter to enter data when the *BFn;L* parameters are used. However, refer to the *data field* description for available characters.

DARK Optional parameter to produce darker looking bar codes. Enter **DARK**. Refer to Dark Printing on page 52 for more information.

SR Defines the starting row for the bar code. Enter a value ranging from row 1 to one less than the length of the form. Character row or dot row is specified based on the Scale command (page 95), or use the CP.DP format (page 24).

SC Defines the starting column of the bar code. Enter a value ranging from column 1 to one less than the width of the form. Character column or dot column is specified based on the Scale command (page 95), or use the CP.DP format (page 24).

(D) The printable character (delimiter) identifying the start and finish of the data field. Enter any printable character other than a slash (/), the SFCC, or a character used within the data. The same character must be used at both ends of the data field, but it will not print with the data.

data field **Interleaved 2/5:** Enter the characters for the bar code data. A null data field (no characters) is permitted. The length of the data field is variable; however, the maximum length is usually limited to 32 characters to minimize potential reading errors. An even number of characters are required for the interleaving process. Consequently, if an odd number of characters are entered in the data field, a leading zero is added

automatically. The characters available for the data field are **0** through **9** (hex 30 through 39).

German I-2/5: The data field must be 11 or 13 digits exactly.

ITF-14: The data field must be 13 digits exactly.

PDF	Optional parameter to enable printing of the human readable data field. Enter PDF to print the data field. If the parameter is not used, the human readable data is not printed. This parameter is not allowed if a null data field was specified. For German I-2/5, fields of the data are separated by dots and spaces.
LOC	Optional parameter to identify the location of the printable data field. The default value is B , locating the human readable data below the bar code. A locates the printable data field above bar code. To compensate for printing the 0.1-inch high data, the height of the bar code body is reduced 0.1-inch.
FONT	Optional parameter to select the font for the human readable data field. Enter O to select OCR-A font; enter X to select OCR-B font; enter N to select 10 cpi; enter P to select 12 cpi; enter Q to select 13 cpi; enter R to select 15 cpi; enter T to select 17 cpi; enter V to select 20 cpi. To select a scalable font with user-defined size, enter Nh:w or F;Nh:w . The parameters h (height) and w (width) can each range from 1 to 96, and are expansion factors of a 10 cpi character. Nh:w prints in Letter Gothic (font 93779) regardless of the current active font. By default F;Nh:w uses the Letter Gothic as the current font selection. You can change the default by using the FONT command.

NOTE: Nh:w and F;Nh:w will not print the PDF wider or taller than the barcode. If the height parameter h causes the PDF to print above the horizontal barcode start row or vertical barcode start column, a barcode font Error will occur. If the width parameter w causes the PDF to exceed the barcode width, the PDF width factor w will automatically reduce to fit within the barcode width without causing an error.

STOP Ends the Bar Code command while the IGP continues in the Create Form Mode. Enter **STOP**. If STOP is not entered, an error message results.

I-2/5 Example

Figure 31 illustrates a horizontal and vertical I-2/5 bar code generated by the following program:

~CREATE;I25	(Enter Create Form Mode)
BARCODE	(Bar Code command)
I-2/5;DARK;49;27	(Dark Code I-2/5, at SR 49, SC 27)
24688642	(Data Field)
PDF;A	(Upper Printable Data Field)
STOP	(Ends Bar Code command)
BARCODE	(New Bar Code command)
I-2/5;VSCAN;H12;DARK;44;52	(Vertical Dark I-2/5, H 1.2 at SR 44, SC 52)
24688642	(Data Field)
PDF	(Printable Data Field)
STOP	(Ends Bar Code command)
END	(Terminates Create Form Mode)
~EXECUTE;I25;1	(Execute the form, form count of 1)
~NORMAL	



Figure 31 Sample I-2/5 Bar Codes

Matrix

The structure for the Matrix bar code is shown in Figure 32 and described on the following pages.

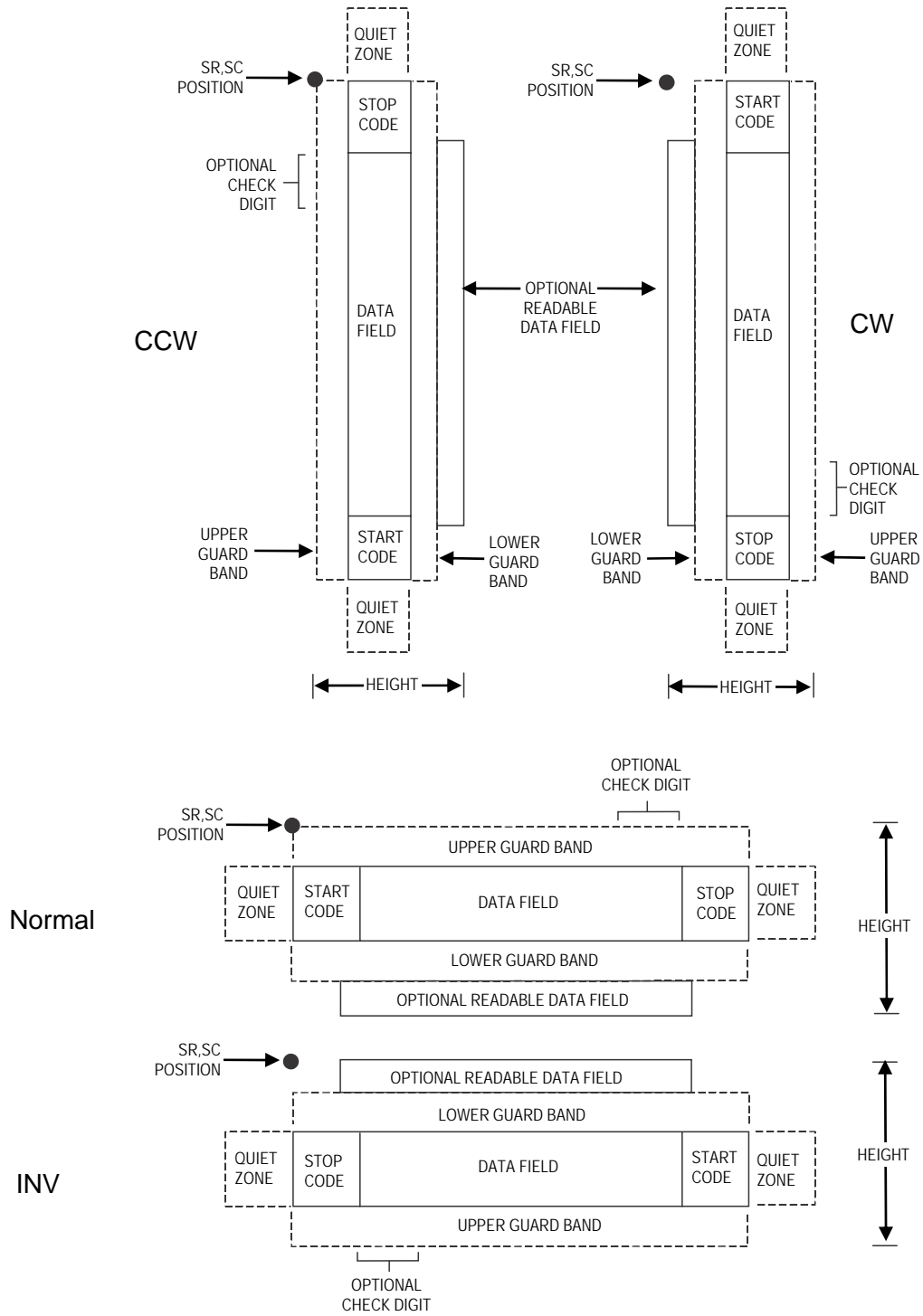

Figure 32 Matrix Structure

Quiet Zone

Both ends of the bar code structure have blank quiet zones. The quiet zones must be at least 0.25 inches wide and completely blank to ensure accurate reading of the start/stop codes and to prevent adjacent bar codes from overlapping. You must provide sufficient space on the form for quiet zones.

Start/Stop Codes

Unique start and stop codes permit bidirectional scanning. Both start and stop codes contain bars and spaces. They are automatically produced.

Data Field

The bar code symbol uses a series of wide and narrow bars and spaces to represent numeric characters. The structure is 2 wide elements (bars or spaces) and 3 narrow elements. In the bar code, each character encoded is separated by a narrow space.

Readable Data

The optional readable data field provides a readable interpretation of the bar code data. It can be printed above or below the bar code symbol.

Check Digit

The modulo-10 check digit can be inserted into the bar code to verify accurate scanning.

Matrix Command Format

BARCODE
MATRIX [CD]; [DIR;] [MAG;] [Hn[.m];] [BFn;L;] [DARK;] SR; SC
(D) [data field] (D) [PDF [;LOC] [;FONT]]
STOP

BARCODE	The Bar Code command; enter BARCODE .
MATRIX CD	Designates bar code type Matrix; enter MATRIX . To calculate and plot the optional modulo-10 check digit with the bar code symbol automatically, enter CD .
DIR	Optional parameter that allows for rotating a barcode. Enter CW for clockwise rotation. Enter CCW or VSCAN for counter-clockwise rotation. Enter INV for inverted rotation. If <i>DIR</i> is not entered, the barcode is horizontally oriented.
MAG	Optional parameter to magnify (horizontally expand) the bar code symbol. The magnification default value is X1 . As required for scanning, enter a magnification value from Table 12, page 106 or Table 13, page 107, depending on your printers tip size to increase the magnification. Increasing the magnification adjusts printed character density. You can also use XR or XRD as defined on page 104.

NOTE: You must specify four digits for MAG for User Defined variable ratio. There are four values that comprise the dot ratio: narrow bar, narrow space, wide bar, and wide space. User-defined ratios for this barcode should have these four values defined in the order specified.

Hn[.m]	Optional parameter to adjust the overall height (vertical expansion) of the bar code symbol (including the upper and lower 0.1-inch guard bands and any human readable data). Height adjustments are made in 0.1-inch increments; enter H and a value from 3 through 99 to select height adjustments from 0.3 through 9.9 inches. The default value is 0.9-inch. [.m] is an additional number of dots for the bar code height. (Dots are in the current dot scale.)
--------	--

NOTE: If 0.3 inches is the selected height, the PDF cannot be included.

<i>BFn;L</i>	Optional parameters for assigning a dynamic bar code data field location on a form and for designating the length of the data field. With these parameters, the actual data for the bar code data field is dynamically provided during the Execute Form Mode; the data is not specified during the Create Form Mode. To use this field, perform the following steps: <ol style="list-style-type: none">Enter BF.Replace <i>n</i> with a number ranging from 0 through 512 to identify the bar code field. The <i>SR</i> and <i>SC</i> parameters specify the exact location of the bar code field identified by <i>n</i>.Replace <i>L</i> with a number equaling the total number of characters in the field. (The actual data provided dynamically during the Execute Form Mode can be less than <i>L</i>.)The information for the data field is entered dynamically during the Execute Form Mode. (Refer to Execute Form: Dynamic Bar Code Data on page 62.) Do not use the <i>data field</i> parameter to enter data when the <i>BFn;L</i> parameters are used. However, refer to the <i>data field</i> description for available characters.
DARK	Optional parameter to produce darker looking bar codes. Enter DARK . Refer to Dark Printing on page 52 for more information.
<i>SR</i>	Defines the starting row for the bar code. Enter a value ranging from row 1 to one less than the length of the form. Character row or dot row is specified based on the Scale command (page 95), or use the CP.DP format (page 24).
<i>SC</i>	Defines the starting column of the bar code. Enter a value ranging from column 1 to one less than the width of the form. Character column or dot column is specified based on the Scale command (page 95), or use the CP.DP format (page 24).
<i>(D)</i>	The printable character (delimiter) identifying the start and finish of the data field. Enter any printable character other than a slash (/), the SFCC, or a character used within the data. The same character must be used at both ends of the data field, but it will not print with the data.
<i>data field</i>	Enter the characters for the bar code data. A null data field (no characters) is permitted. The length of the data field is variable; however, the maximum length is usually limited to 32 characters to minimize potential reading errors. An even number of characters are required for the interleaving process. Consequently, if an odd number of characters are entered in the data field, a leading zero is added automatically. The characters available for the data field are 0 through 9 (hex 30 through 39).
PDF	Optional parameter to enable printing of the human readable data field. Enter PDF to print the data field. If the parameter is not used, the human readable data is not printed. This parameter is not allowed if a null data field was specified.
<i>LOC</i>	Optional parameter to identify the location of the printable data field. The default value is B , locating the human readable data below the bar code. A locates the printable data field above bar code. To compensate for printing the 0.1-inch high data, the height of the bar code body is reduced 0.1-inch.

FONT

Optional parameter to select the font for the human readable data field. Enter **O** to select OCR-A font; enter **X** to select OCR-B font; enter **N** to select 10 cpi; enter **P** to select 12 cpi; enter **Q** to select 13 cpi; enter **R** to select 15 cpi; enter **T** to select 17 cpi; enter **V** to select 20 cpi.

To select a scalable font with user-defined size, enter **Nh:w** or **F;Nh:w**. The parameters h (height) and w (width) can each range from 1 to 96, and are expansion factors of a 10 cpi character. Nh:w prints in Letter Gothic (font 93779) regardless of the current active font. By default F;Nh:w uses the Letter Gothic as the current font selection. You can change the default by using the FONT command.

NOTE: Nh:w and F;Nh:w will not print the PDF wider or taller than the barcode. If the height parameter h causes the PDF to print above the horizontal barcode start row or vertical barcode start column, a barcode font Error will occur. If the width parameter w causes the PDF to exceed the barcode width, the PDF width factor w will automatically reduce to fit within the barcode width without causing an error.

STOP

Ends the Bar Code command while the IGP continues in the Create Form Mode. Enter **STOP**. If STOP is not entered, an error message results.

Matrix Example

Figure 33 illustrates a horizontal and vertical Matrix bar code generated by the following program:

```
~CREATE;MATRIX          (Enter Create Form Mode)
BARCODE                 (Bar Code command)
MATRIX;DARK;49;27      (Dark Code Matrix, at SR 49, SC 27)
*24688642*             (Data Field)
PDF                     (Printable Data Field)
STOP                    (Ends Bar Code command)
BARCODE                 (New Bar Code command)
MATRIX;VSCAN;H12;DARK;44;52 (Vertical Dark Matrix, H 1.2 at SR 44,
                        SC 52)
*24688642*             (Data Field)
PDF                     (Printable Data Field)
STOP                    (Ends Bar Code command)
END                     (Terminates Create Form Mode)
~EXECUTE;MATRIX;1      (Execute the form, form count of 1)
~NORMAL
```

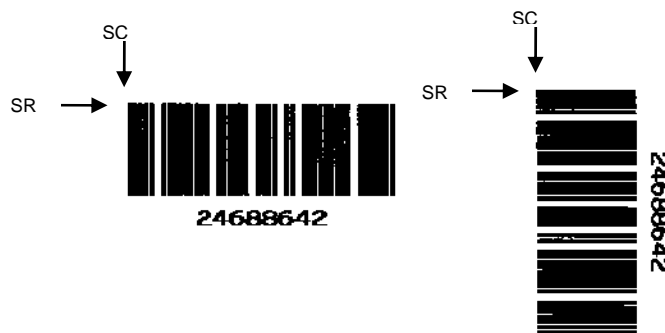

Figure 33 Sample Matrix Bar Codes

MSI

The MSI bar code structure is shown in Figure 34 and described on the following pages.

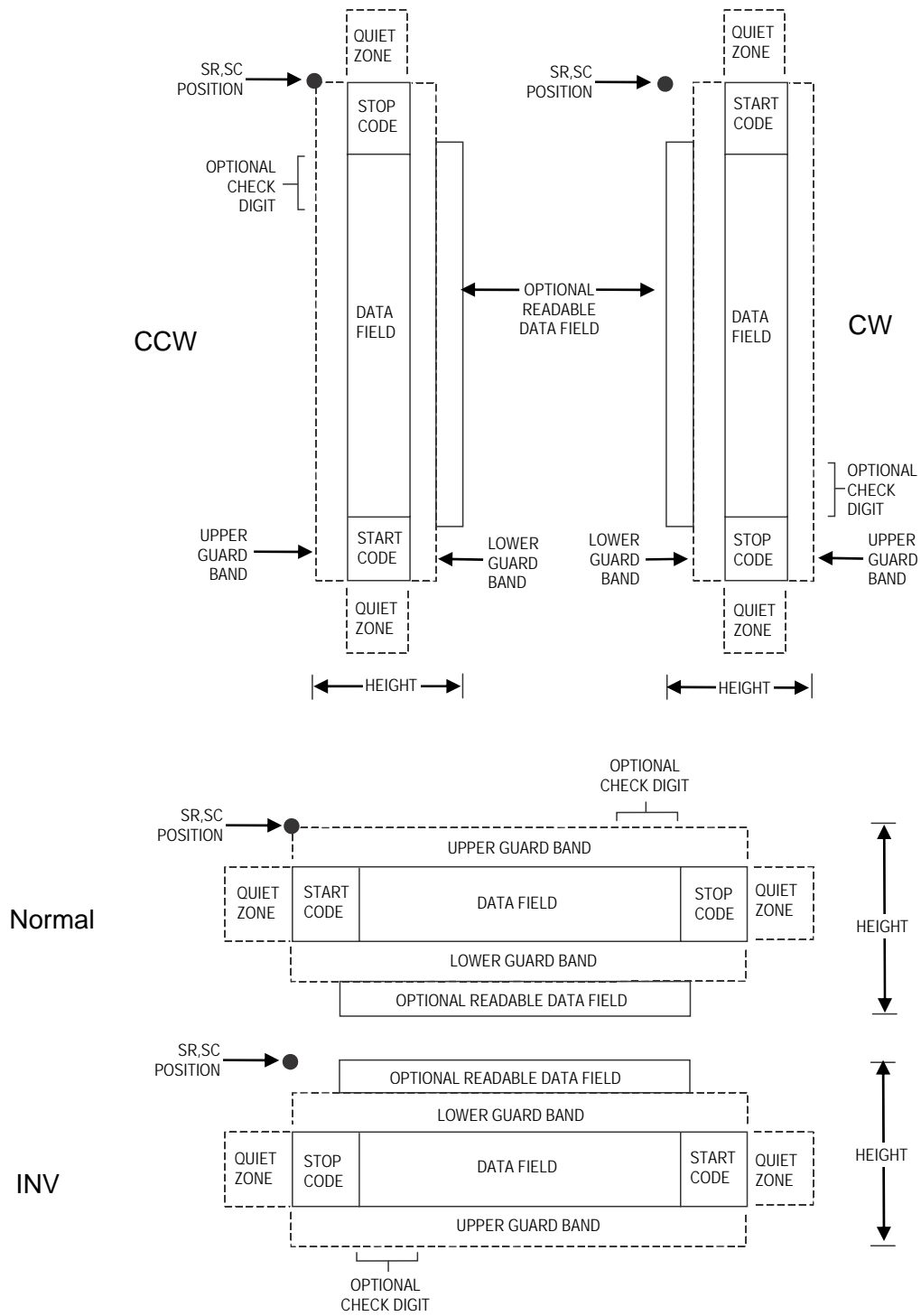

Figure 34 MSI Structure

Quiet Zone

Both ends of the bar code structure require blank quiet zones. The quiet zones must be at least 0.25-inches wide and completely blank to ensure accurate reading of the start/stop codes and to prevent adjacent bar codes from overlapping. You must provide sufficient space on the form for the quiet zones.

Start/Stop Code

Unique start and stop codes permit bidirectional scanning. Both start and stop codes contain bars and spaces. They are automatically produced.

Data Field

The bar code symbol uses a series of wide and narrow bars and spaces to represent each numeric character. The structure is four wide elements (bars or spaces) and four narrow elements. Each character contains four data bits, with each 0-bit made up of a narrow bar/wide space arrangement and each 1-bit made up of a wide bar/narrow space arrangement.

Readable Data

The optional readable data field provides a readable interpretation of the bar code data. It can be printed above or below the bar code symbol.

Check Digit

If specified, the modulo-10 or modulo-11 (or both) check digit is automatically calculated and inserted in the bar code symbol. The check digit verifies accurate scanning.

MSI Command Format

BARCODE

MSI *n*; [*DIR*;] [*MAG*;] [*Hn* [*.m*];] [*BFn*; *L*;] [*DARK*;] *SR*; *SC*

(*D*) [*data field*] (*D*)

[*PDF* [:*LOC*] [:*FONT*]]

STOP

BARCODE	The Bar Code command; enter BARCODE .
MSI	Designates bar code type MSI; enter MSI .
<i>n</i>	Designates the type of check digit combinations for the bar code. Replace <i>n</i> with one of the following codes to specify the check digit. A single-digit modulo-10 followed by a second modulo-10 digit B single-digit modulo-11 followed by a single modulo-10 digit C single-digit modulo-10 D single-digit modulo-11
<i>DIR</i>	Optional parameter that allows for rotating a barcode. Enter CW for clockwise rotation. Enter CCW or VSCAN for counter-clockwise rotation. Enter INV for inverted rotation. If <i>DIR</i> is not entered, the barcode is horizontally oriented.
<i>MAG</i>	Optional parameter to magnify (horizontally expand) the bar code symbol. The magnification default value is X1 . As required for scanning, enter a magnification value from Table 12, page 106 or Table 13, page 107, depending on your printers tip size to increase the magnification. Increasing the magnification adjusts printed character density. You can also use XR or XRD as defined on page 104.

NOTE: You must specify four digits for MAG for User Defined variable ratio. There are four values that comprise the dot ratio: narrow bar, narrow space, wide bar, and wide space. User-defined ratios for this barcode should have these four values defined in the order specified.

Hn[.m] Optional parameter to adjust the overall height (vertical expansion) of the bar code symbol (including the upper and lower 0.1-inch guard bands and any human readable data). Height adjustments are made in 0.1-inch increments; enter **H** and a value from **3** through **99** to select height adjustments from 0.3 through 9.9 inches. The default value is 0.9-inch. [.m] is an additional number of dots for the bar code height. (Dots are in the current dot scale.)

NOTE: If 0.3 inches is the selected height, the PDF cannot be included.

BFn;L Optional parameters for assigning a dynamic bar code data field location on a form and for designating the length of the data field. With these parameters, the actual data for the bar code data field is dynamically provided during the Execute Form Mode; the data is not specified during the Create Form Mode. To use this field:

- a. Enter **BF**.
- b. Replace *n* with a number ranging from **0 through 512** to identify the bar code field. The *SR* and *SC* parameters specify the exact location of the bar code field identified by *n*.
- c. Replace *L* with a number equaling the total number of characters in the field. (The actual data provided dynamically during the Execute Form Mode can be less than *L*.)
- d. The information for the data field is entered dynamically during the Execute Form Mode. (Refer to Execute Form: Dynamic Bar Code Data on page 62.) Do not use the *data field* parameter to enter data when the *BFn;L* parameters are used. However, refer to the *data field* description for available characters.

DARK Optional parameter to produce darker looking bar codes. Enter **DARK**. Refer to Dark Printing on page 52 for more information.

SR Defines the starting row for the bar code. Enter a value ranging from row 1 to one less than the length of the form. Character row or dot row is specified based on the Scale command (page 95), or use the CP.DP format (page 24).

SC Defines the starting column of the bar code. Enter a value ranging from column 1 to one less than the width of the form. Character column or dot column is specified based on the Scale command (page 95), or use the CP.DP format (page 24).

(D) The printable character (delimiter) identifying the start and finish of the data field. Enter any printable character other than a slash (/), the SFCC, or a character used within the data. The same character must be used at both ends of the data field, but it will not print with the data.

data field Enter the characters for the bar code data. A null data field (no characters) is permitted. The length of the data field is variable; however, a maximum of 14 data characters are allowed if a one-character check digit field is specified; a maximum of 13 data characters are allowed if a two-character check digit field is specified. The characters available for the data field are **0** through **9** (hex 30 through 39).

PDF	Optional parameter to enable printing of the human readable data field. Enter PDF to print the data field. If the parameter is not used, the human readable data will not print.
LOC	Optional parameter to identify the location of the printable data field. The default value is B , locating the human readable data below the bar code. A locates the printable data field above the bar code. To compensate for printing the 0.1-inch high data, the height of the bar code body is reduced 0.1-inch.
FONT	Optional parameter to select the font for the human readable data field. Enter O to select OCR-A font; enter X to select OCR-B font; enter N to select 10 cpi; enter P to select 12 cpi; enter Q to select 13 cpi; enter R to select 15 cpi; enter T to select 17 cpi; enter V to select 20 cpi. To select a scalable font with user-defined size, enter Nh:w or F;Nh:w . The parameters h (height) and w (width) can each range from 1 to 96, and are expansion factors of a 10 cpi character. Nh:w prints in Letter Gothic (font 93779) regardless of the current active font. By default F;Nh:w uses the Letter Gothic as the current font selection. You can change the default by using the FONT command.

NOTE: Nh:w and F;Nh:w will not print the PDF wider or taller than the barcode. If the height parameter h causes the PDF to print above the horizontal barcode start row or vertical barcode start column, a barcode font Error will occur. If the width parameter w causes the PDF to exceed the barcode width, the PDF width factor w will automatically reduce to fit within the barcode width without causing an error.

STOP Ends the Bar Code command while the IGP continues in the Create Form Mode. Enter **STOP**. If STOP is not entered, an error message results.

MSI Example

Figure 35 illustrates a horizontal and vertical MSI bar code generated by the following program:

```

~CREATE;MSI                (Enter Create Form Mode)
BARCODE                    (Bar Code command)
MSIA;DARK;32;27            (Dark Bar Code MSIA at SR 32, SC 27)
*24688642*                (Data Field)
PDF;X                      (Printable Data Field, OCR-B)
STOP                       (Ends Bar Code command)
BARCODE                    (New Bar Code command)
MSIB;VSCAN;X2;H12;DARK;32;54 (Vertical Dark MSIB, Mag 2, H 1.2 at
                           SR 32, SC 54)
*24688642*                (Data Field)
PDF;A                      (Upper Data Field)
STOP                       (Ends Bar Code command)
END                        (Terminates Create Form Mode)
~EXECUTE;MSI;1             (Execute the form, form count of 1)
~NORMAL

```

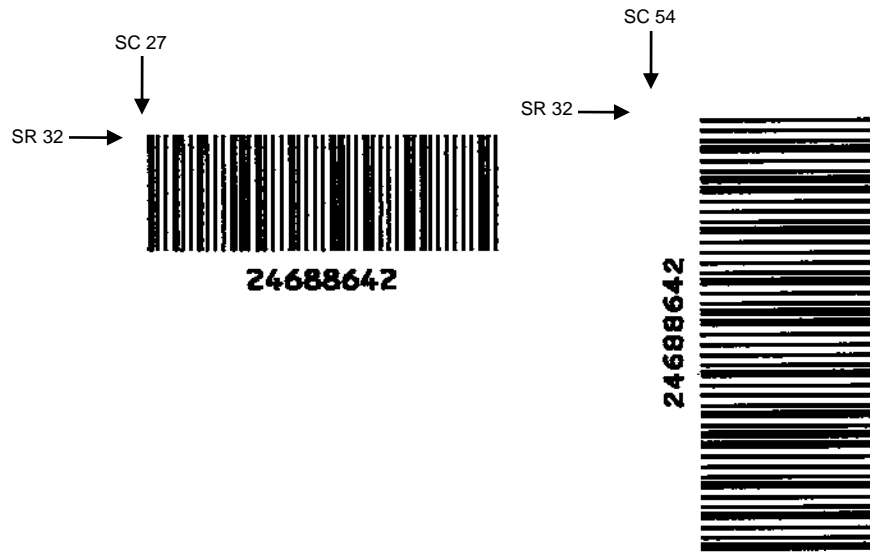

Figure 35 Sample MSI Bar Codes

PDF417

The PDF417 structure is shown in Figure 36 and described on the following pages.

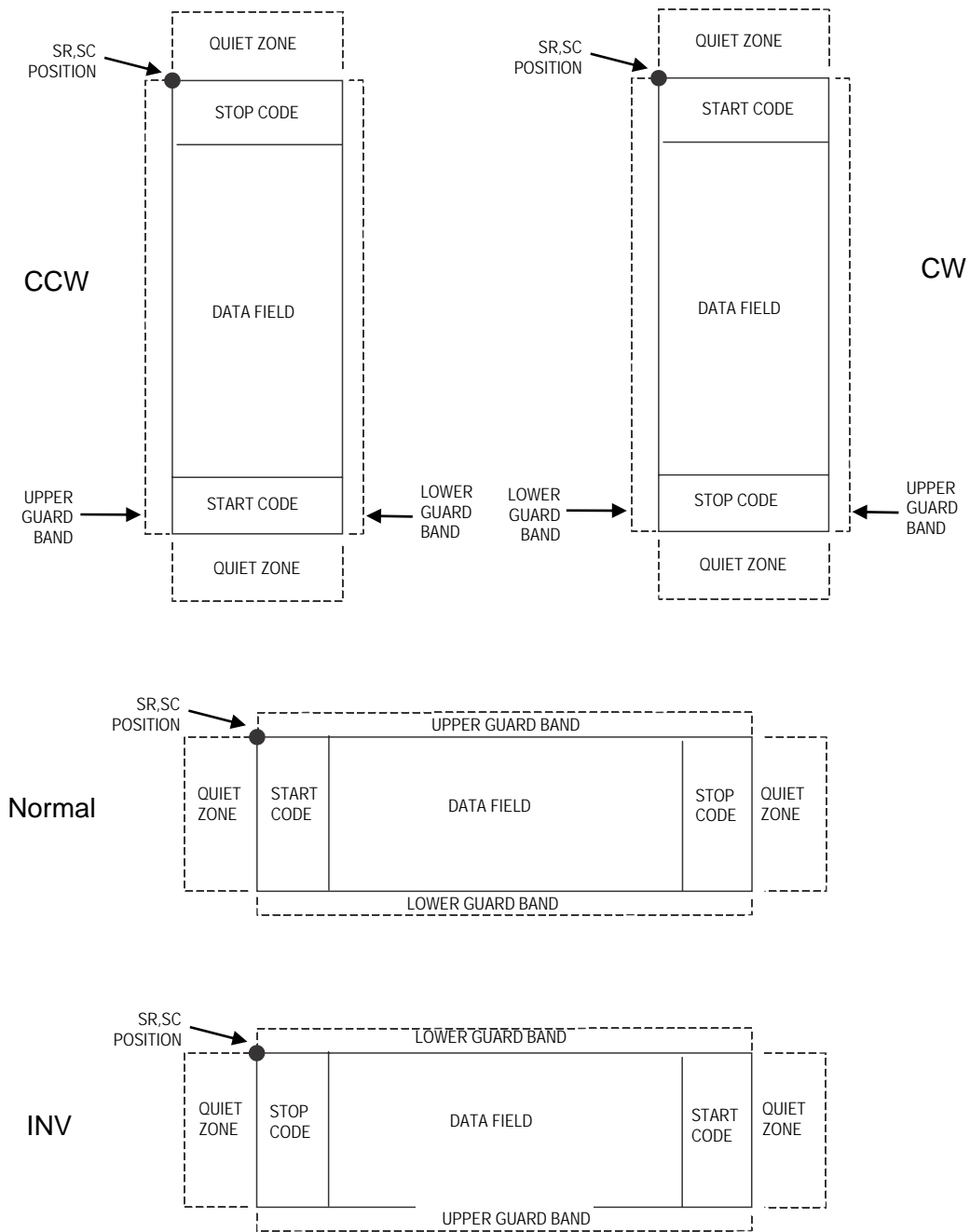

Figure 36 PDF417 Structure

Quiet Zone

Both ends of the bar code structure require blank quiet zones. The quiet zones must be at least 0.25 inches wide and completely blank to ensure accurate reading of the start/stop codes and to prevent adjacent bar codes from overlapping. Be sure to provide sufficient space on the form for the quiet zones.

Start/Stop Codes

The start/stop codes identify the leading and trailing end of the bar code.

Data Field

PDF417 provides twelve modes to encode data. The first three are pre-established (the remaining nine are user modes, which can be defined by users or industry associations according to specific applications):

1. Extended Alphanumeric Compaction mode (EXC). Comprised of four sub-modes, this mode offers encodation of all printable ASCII characters. This is the default mode; the IGP uses shift or latch characters to enable other modes.
2. Binary/ASCII Plus mode. This offers encodation for all uppercase ASCII characters only, printable or not, and binary values.
3. Numeric Compaction mode. This offers encodation for numeric values to a density of almost 3 digits per code word.
4. The IGP will automatically switch between modes to provide the smallest encodation for the data.

Security Level

PDF417 can detect and correct errors. Each label has 2 code words of error detection. You can select the error correction capacity based on application needs. Specify a security level in the range of 0 - 8, at the time of printing. PDF417 can also recover from omissions and misdecodes of code words. Since it requires two code words to recover from a misdecode, one to detect the error and one to correct for it, a given security level can support half the number of misdecodes that it can of undecoded words.

PDF

Print Data Field is not offered due to the large amount of data that can be encoded.

PDF417 Command Format

BARCODE

PDF417; [MICRO or MACRO;] [DIR;] [X[D]n;] [Y[D]n;] [(Hn)|
(Wn);] [ASPECTh:w;] [(Rn) | (Cn);] [BIN;] [S[%]n;][BFn;L;]
[DARK;] SR; SC [(D)data field(D)]

STOP

BARCODE	The Bar Code command; enter BARCODE .
PDF417	Designates bar code type PDF417; enter PDF417 .
MICRO	Selects Micro-PDF417. See Table 34 on page 203.
MACRO	Selects Macro-PDF417. This enables encoding of a Macro Control Block in the data field using escape sequences. See Table 35 and Table 36 on page 205.
DIR	Optional parameter that allows for rotating a barcode. Enter CW for clockwise rotation. Enter CCW or VSCAN for counter-clockwise rotation. Enter INV for inverted rotation. If <i>DIR</i> is not entered, the barcode is horizontally oriented.
X[D]n	Optional parameter that designates the width of a narrow element in IGP dots, or printer dots if option [D] is used. The default is one IGP dot. For

horizontal barcodes, this results in 2/72 inch. For rotated barcodes, this equal 3/120 inch. Values range from 1 to 1000 printer dots.

Y[D]*n* Optional parameter that designates the height of the narrow element in IGP dots, or printer dots if option [D] is used. The default is one IGP dot. For horizontal barcodes, this results in 2/72 inch. For rotated barcodes, this equals 3/120 inch. Values range from 1 to 100 printer dots.

H*n* Optional parameter to adjust the maximum height of the bar code symbol. Height adjustments are made in 0.1-inch increments; enter **H** and a value from **4** through **99** to select height adjustments from 0.4 through 9.9 inches.

NOTE: The default aspect ratio will be used until the resulting barcode height exceeds the specified maximum.

Parameters *Wn*, *Rn*, *Cn* or ASPECT cannot be entered if this parameter is used.

NOTE: The Micro-PDF417 values range from 1 to 99.

W*n* Optional parameter to adjust the maximum width of the symbol based on the narrow element width. Enter **W*n***; where *n* is the overall width in tenths of an inch.

NOTE: The default aspect ratio will be used until the resulting barcode width exceeds the specified maximum.

Parameters *Hn*, *Rn*, *Cn* or ASPECT cannot be entered if this parameter is used.

ASPECT*h:w* Optional parameter for specifying the symbol height-to-width ratio where *h* is the height and *w* is the width, both expressed as integers. The default is 1:2. Parameters *Hn*, *Wn*, *Rn*, or *Cn* cannot be entered if this parameter is used. This parameter is not applicable to Micro PDF417.

R*n* Optional parameter that specifies the number of rows the symbol will have. Enter **R** followed by the number of rows in the range of **3** through **90** in multiples of 3. Parameters *Hn*, *Wn*, *Cn* or ASPECT cannot be entered if this parameter is used. Micro-PDF417 only allows for a certain predefined combination of Rows and Columns. Therefore both R and C parameters can be specified to select a valid combination. See Table 34 on page 203 for allowed combinations.

NOTE: When these parameters are omitted, the printer automatically determines the smallest possible values.

C*n* Optional parameter that specifies the number of columns the symbol will have. Enter **C** followed by the number of columns in the range of **1** through Parameters *Hn*, *Wn*, *Rn* or ASPECT cannot be entered if this parameter is used. Micro-PDF417 only allows for a certain predefined combination of Rows and Columns. Therefore both R and C parameters can be specified to select a valid combination. See Table 34 on page 203 for allowed combinations.

NOTE: When these parameters are omitted, the printer automatically determines the smallest possible values.

BIN Force Micro-PDF417 to encode the data using byte-compaction mode. This provides the best encoding for 8-bit binary data.

S[%]n	Optional parameter that specifies the security level. Enter S followed by the security level in the range of 0 through 8 . The default is 2. If [%] is included, the security level is specified as a percentage. Valid values range from 0 to 100. Changing the security level can affect the amount of data in the barcode symbol, hence its size. This parameter is not applicable to Micro-PDF417
BFn;L	Optional parameters for assigning a dynamic bar code data field location on a form and for designating the length of the data field. With these parameters, the actual data for the bar code data field is dynamically provided during the Execute Form Mode; the data is not specified during the Create Form Mode. To use this field, perform the following steps: <ol style="list-style-type: none"> a. Enter BF. b. Replace <i>n</i> with a number ranging from 0 through 512 to identify the bar code field. The <i>SR</i> and <i>SC</i> parameters specify the exact location of the bar code field identified by <i>n</i>. c. Replace <i>L</i> with a number equaling the total number of characters in the field. (The actual data provided dynamically during the Execute Form Mode can be less than <i>L</i>.) d. The information for the data field is entered dynamically during the Execute Form Mode. (Refer to Execute Form: Dynamic Bar Code Data on page 62.) Do not use the <i>data field</i> parameter to enter data when the <i>BFn;L</i> parameters are used. However, refer to the <i>data field</i> description for available characters.
DARK	Optional parameter to produce darker looking bar codes. Enter DARK . Refer to Dark Printing on page 52 for more information.
SR	Defines the starting row for the bar code. Enter a value ranging from row 1 to one less than the length of the form. Character row or dot row is specified based on the Scale command (page 95), or use the CP.DP format (page 24).
SC	Defines the starting column of the bar code. Enter a value ranging from column 1 to one less than the width of the form. Character column or dot column is specified based on the Scale command (page 95), or use the CP.DP format (page 24).
(D)	The printable character (delimiter) identifying the start and finish of the data field. Enter any printable character other than a slash (/), the SFCC, or a character used within the data. The same character must be used at both ends of the data field, but it will not print with the data.
<i>data field</i>	Enter the data for the bar code. A null data field (no characters) is not permitted. The data field can contain any uppercase ASCII characters including carriage returns and line feeds. The length of the data field is variable; however, the maximum length is usually limited to 1024 bytes to minimize potential reading errors.
NOTE: New lines (i.e. carriage returns/line feeds) are allowed in the PDF417 data field and as PDF417 dynamic data field input.	
STOP	Ends the Bar Code command while the IGP continues in the Create Form Mode. Enter STOP . If STOP is not entered, an error message results.

PDF417 Example

Figure 37 illustrates a horizontal PDF417 bar code generated by the following program:

```
~CREATE;PDF417                (Enter Create Form Mode)
BARCODE                        (Bar Code command)
PDF417;XD3;YD9;S0;37;21      (PDF417; width; height, security
                              level, SR 37, SC 21)
*ACME MOTOR SUPPORTS PRINTING OF PDF417 TWO-DIMENSIONAL BAR CODE SYMBOLOGY
123456789012345678901234567890123456789*
STOP                          (Ends Bar Code command)
END                            (Terminate Create Form Mode)
~EXECUTE;PDF;1                (Execute the form)
~NORMAL
```

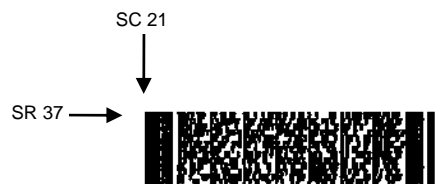

Figure 37 Sample PDF417 Bar Code

Micro-PDF417

Micro-PDF417 is a multi-low symbology which may be utilized by applications needing to encode a moderate amount of data in a two-dimensional symbol (up to 150 bytes, 250 to alphanumeric characters, or 366 numeric digits), and when minimizing symbol size is a primary concern. Micro-PDF417 is identical to PDF417 in terms of its encodation modes, error correction method, and symbol character sets. However, Micro-PDF417 replaces PDF417's 17 module wide start/stop patterns and left/right row indicators with a unique set of 10-module wide Row Address Patterns, which were designed both to reduce overall symbol width and to facilitate linear scanning at row heights as low as 2X.

Unlike PDF417, Micro-PDF417 may only be printed in certain defined combinations of *r* (number of rows), *c* (number of columns), and *k* (number of error correction codewords), up to a maximum of four data columns by 44 rows.

See Table 34 on page 203 for the possible combinations of rows and columns, the maximum allowed data amount, and the error-correction level for each combination.

Table 34 Micro-PDF417 Combinations

Number of Data Columns	Number of Data Rows	% of Codewords for Error Correction	Max Uppercase Alpha Characters	Max Digits	Max 8-bit Characters
1	11	64	6	8	3
	14	50	12	17	7
	17	41	18	26	10
	20	40	22	32	13
	24	33	30	44	18
	28	29	38	55	22
	8	50	14	20	8
2	11	41	24	35	14
	14	32	36	52	21
	17	29	46	67	27
	20	28	56	82	33
	23	28	64	93	38
	26	29	72	105	43
	6	67	10	14	6
	3	8	58	18	26
10		53	26	38	15
12		50	34	49	20
15		47	46	67	27
20		43	66	96	39
26		41	90	132	54
32		40	114	167	68
38		39	138	202	82
44		38	162	237	97

Table 34 Micro-PDF417 Combinations

Number of Data Columns	Number of Data Rows	% of Codewords for Error Correction	Max Uppercase Alpha Characters	Max Digits	Max 8-bit Characters
4	4	50	14	20	8
	6	50	22	32	13
	8	44	34	49	20
	10	40	46	67	27
	12	38	58	85	34
	15	35	76	111	45
	20	33	106	155	63
	26	31	142	208	85
	32	30	178	261	106
	38	29	214	313	128
	44	28	250	366	150

MACRO-PDF417

When the MACRO parameter is specified in the PDF417 Command, the data field is scanned for special escape sequences describing a "Macro Control Block" as defined in Appendix G of the Uniform Symbology Specification PDF417.

The escape sequences start with the SO (Shift Out) Character followed by three digits. The default SO character is 14 (0x0E hex), however the examples in this document will use a backslash (92, 0x5C hex) for clarity. The SO character is configurable on the control panel.

The Macro PDF417 Control Block is located at the end of the data field, following the normal PDF417 user data. The parameter uses the following format as shown in Table 35.

Table 35 Mandatory Macro-PDF-417 Fields

Field	Description
\928	Macro Block Control Header Indicates the start of a Macro block.
0 - 99998	Segment Index Each barcode in a Macro PDF sequence must have a unique segment index that indicates the position of the barcode within the sequence.
\nnn...\nnn	File ID A variable number of escape sequences containing values from \000 to \899. Each barcode in a Macro PDF sequence must have the same File ID assigned to it. Zero or more optional Fields may follow the File ID. See the next section for a description of the optional fields.
\922	Terminator The barcode that represents the last segment of a Macro PDF sequence should have the \922 escape sequence at the end of the Macro Block.

A Macro PDF sequence may contain zero or more optional fields. Except for the Segment-Count field, these fields describe global file attributes of the Macro PDF sequence, and therefore do not need to be present in all segments. The optional fields, if present, should be placed after the File ID, and have the layout described in Table 36.

NOTE: Other than the data type and length, the printer does not verify the contents of the optional fields.

Table 36 Optional Macro-PDF-417 Fields

Field	Description	Data Type	Field Length
\923\000	File Name	Text	Variable
\923\001	Segment Count 00001 - 99999. NOTE: If this field is used, it must be present in all segments.	Numeric	5
\923\002	Time Stamp Time in seconds since January 1, 1970 00:00 GMT	Numeric	11
\923\003	Sender	Text	Variable
\923\004	Addressee	Text	Variable
\923\005	File Size	Numeric	Variable
\923\006	Checksum 16-bit CRC checksum over the entire source file. This checksum value must be a decimal value from 0 through 65,535.	Numeric	5

Planet

The Planet bar code was introduced by the U.S. Postal Service under the product name "Confirm." Planet is a 12-digit bar code used to track mail electronically, both inbound and outbound. Under the "Confirm" process, the first two digits of the Planet data field defines the service expected. The next nine digits are customer information, and the last digit is the check digit.

The Planet bar code structure is illustrated in Figure 38 and Figure 39 and described on the following pages. The Planet code can be a part of the address block and appear anywhere within a vertical 4-inch area across the length of the mail piece.

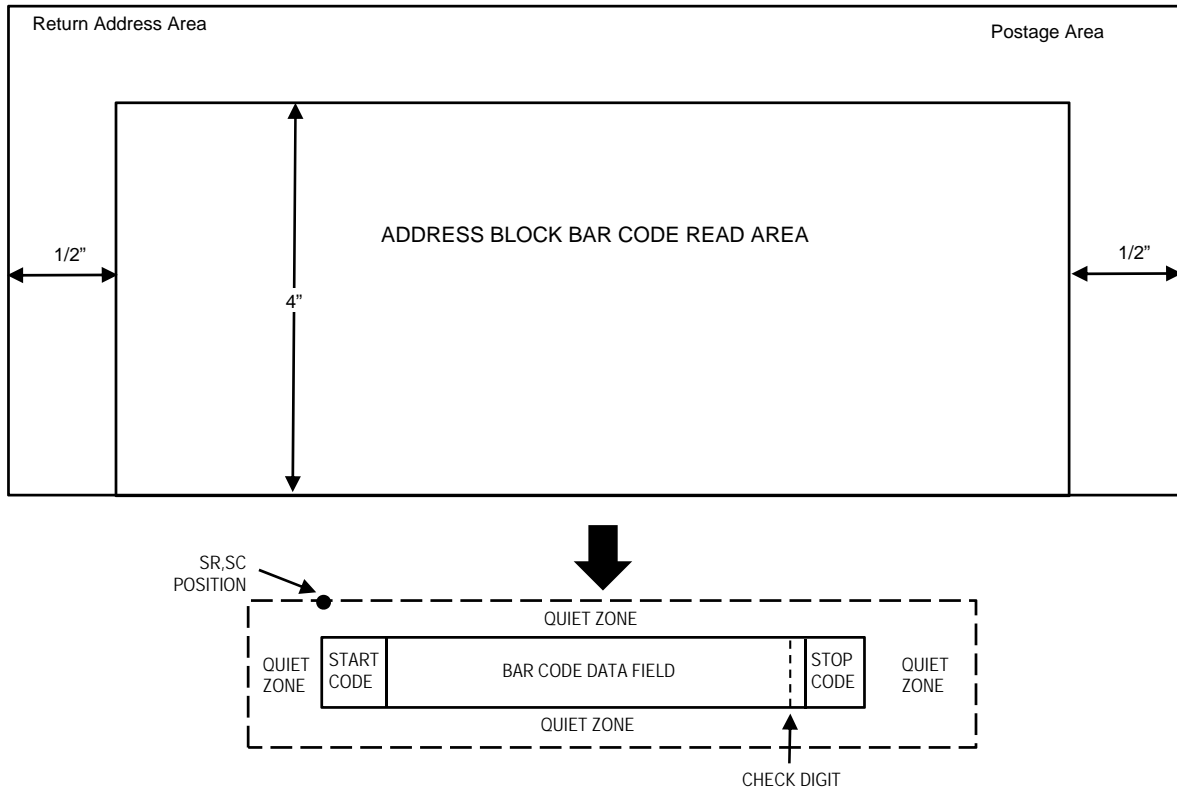

NOTE: Illustration is not to scale

Figure 38 Planet Structure

NOTE: Additional information regarding Planet bar code requirements can be obtained from the U.S. Postal Service's Publication 25: *A Guide to Business Mail Preparation*.

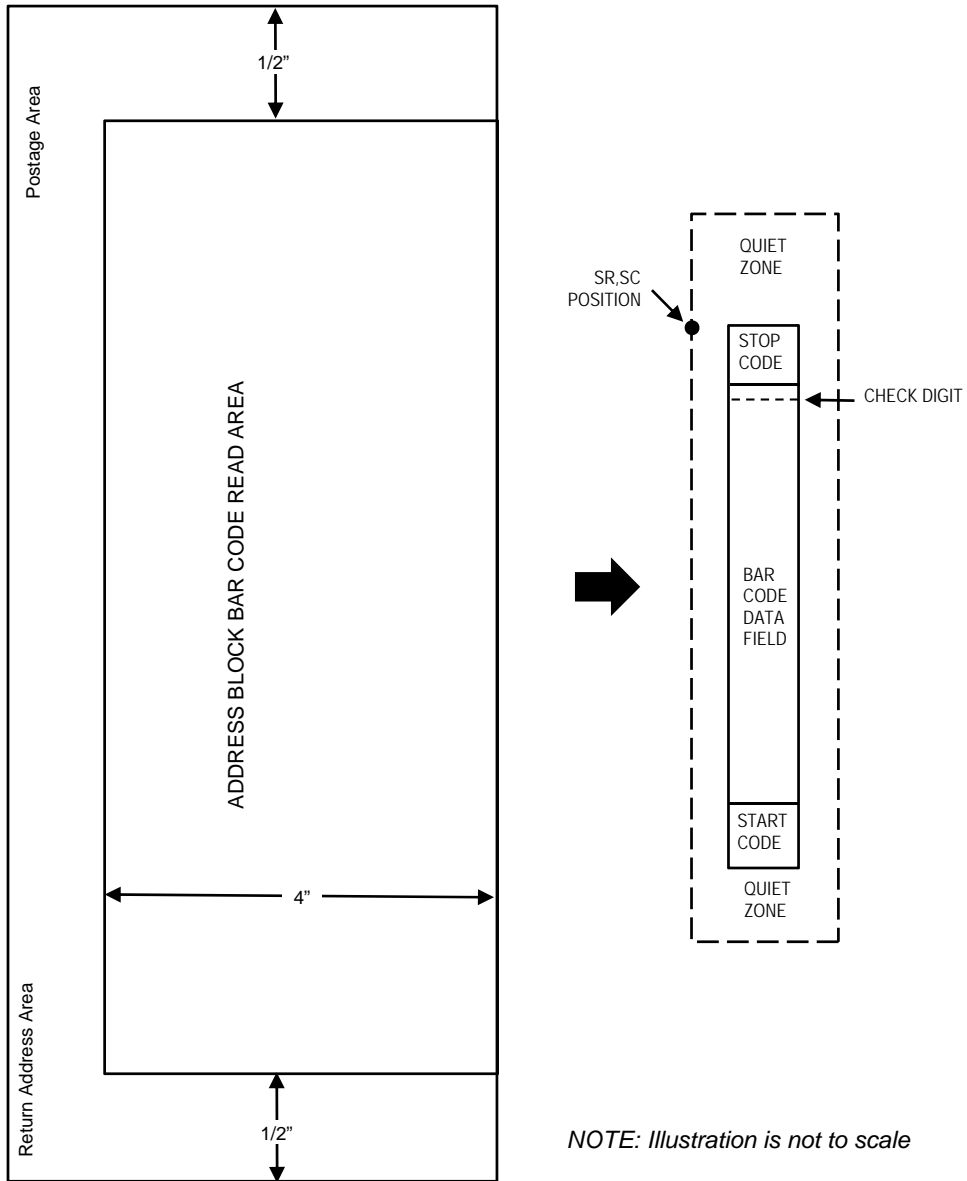

NOTE: Illustration is not to scale

Figure 39 Planet Structure (VSCAN or CCW)

Quiet Zone

The bar code structure requires a completely blank quiet zone which extends 4.75 inches from the right edge of the mail piece. In addition, a minimum quiet zone of 0.040-inch above and below the bar code data must also be provided. You must provide sufficient space for this zone.

Start/Stop Code

The start and stop codes are referred to as “framing bars” in Planet. The start and stop codes are each one tall bar, one identifying the leading and trailing end of the bar code. The start/stop code is automatically produced with each bar code. The start/stop code structure permits bar code scanning in a left-to- right direction only.

Data Field

The bar code data produces a single field of 60 bars for an 11-digit data field. The bars are grouped in sets of five. Each set of five bars (comprised of three tall bars and two short bars) represents one of the five digits of the zip code, plus the four-digit zip code extension. If the Advanced Bar Code is used, an additional two-digit code is also added to make an 11-digit data field.

Each bar width is equal, and must be .020-inch \pm .005-inch. Each bar height is either a tall (full) or short (half) bar, representing a 1 or 0, respectively. Each tall bar must be .125-inch \pm .010-inch; each short bar must be .050-inch \pm .010-inch. Horizontal spacing between bars (pitch) must be 22 bars \pm 2 bars per inch over any 0.50-inch portion of the bar code. Horizontal spacing at 24 and 20 bars per inch is 0.0416-inch and .050-inch, respectively, with a clear vertical space ranging from 0.012-inch to 0.040-inch between bars.

Check Digit

The twelfth digit represents the automatic check digit character. The check digit is added automatically to verify accurate scanning.

Planet Command Format

```
BARCODE  
PLANET; [DIR;] [NLQ;] [BFn;L;] [DARK;] SR; SC  
(D)data field(D)  
STOP
```

BARCODE	The Bar Code command; enter BARCODE .
PLANET	Designates bar code type Planet; enter PLANET .
DIR	Optional parameter that allows for rotating a barcode. Enter CW for clockwise rotation. Enter CCW or VSCAN for counter-clockwise rotation. Enter INV for inverted rotation. If <i>DIR</i> is not entered, the barcode is horizontally oriented.
NLQ	Optional parameter optimized to print barcodes at NLQ print density (180x96). This may cause line matrix printers to reverse motion when the form prints. This parameter is ignored for other printer types.
BFn;L	Optional parameters for assigning a dynamic bar code data field location on a form and for designating the length of the data field. With these parameters, the actual data for the bar code data field is dynamically provided during the Execute Form Mode; the data is not specified during the Create Form Mode. To use this field, perform the following steps: <ol style="list-style-type: none">Enter BF.Replace <i>n</i> with a number ranging from 0 through 512 to identify the bar code field. The <i>SR</i> and <i>SC</i> parameters specify the exact location of the bar code field identified by <i>n</i>.

- c. Replace *L* with a number equaling the total number of characters in the field. The data field must be numeric and contain exactly 11 digits. (The actual data provided dynamically during the Execute Form Mode can be less than *L*.)
- d. The information for the data field is entered dynamically during the Execute Form Mode. (Refer to Execute Form: Dynamic Bar Code Data on page 62.) Do not use the *data field* parameter to enter data when the *BF_n;L* parameters are used. However, refer to the *data field* description for available characters.

DARK	Optional parameter to produce darker looking bar codes. Enter DARK . Refer to Dark Printing on page 52 for more information.
SR	Defines the starting row for the bar code. Enter a value within the range of the 4-inch vertical address block. Character row or dot row is specified based on the Scale command (page 95), or use the CP.DP format (page 24).
SC	Defines the starting column of the bar code. Enter a value between the 1/2-inch left and right margins of the mail piece. Character column or dot column is specified based on the Scale command (page 95), or use the CP.DP format (page 24).
(D)	The printable character (delimiter) identifying the start and finish of the data field. Enter any printable character other than a slash (/) the SFCC, or a character used within the data. The same character must be used at both ends of the data field but it will not print with the data.
<i>data field</i>	The bar code data. Enter 11 digits. The available characters for the data field are 0 through 9 (hex 30 through 39).
STOP	Ends the Bar Code command while the IGP continues in the Create Form Mode. Enter STOP . If STOP is not entered, an error message will result.

Planet Example

Figure 40 illustrates a horizontal and vertical Planet bar code generated by the following program:

```
~CREATE;TEST (Enter Create Form Mode)
BARCODE (Bar code command)
PLANET;DARK;11;15 (Dark Planet bar code at SR 11, SC 15)
*01675433738* (11-digit data field)
STOP (Ends Bar Code command)
BARCODE (Bar code command)
PLANET;VSCAN;DARK;5;48 (Dark Vertical bar code Planet at
SR 5, SC 48)
*01858022199* (11-digit data field)
STOP (Ends Bar Code command)
END (Terminates Create Form Mode)
~EXECUTE;TEST;1 (Execute the form, with form count of 1)
~NORMAL
```



Figure 40 Sample Planet Bar Codes

Plessey

The Plessey bar code structure is shown in Figure 41 and described on the following pages.

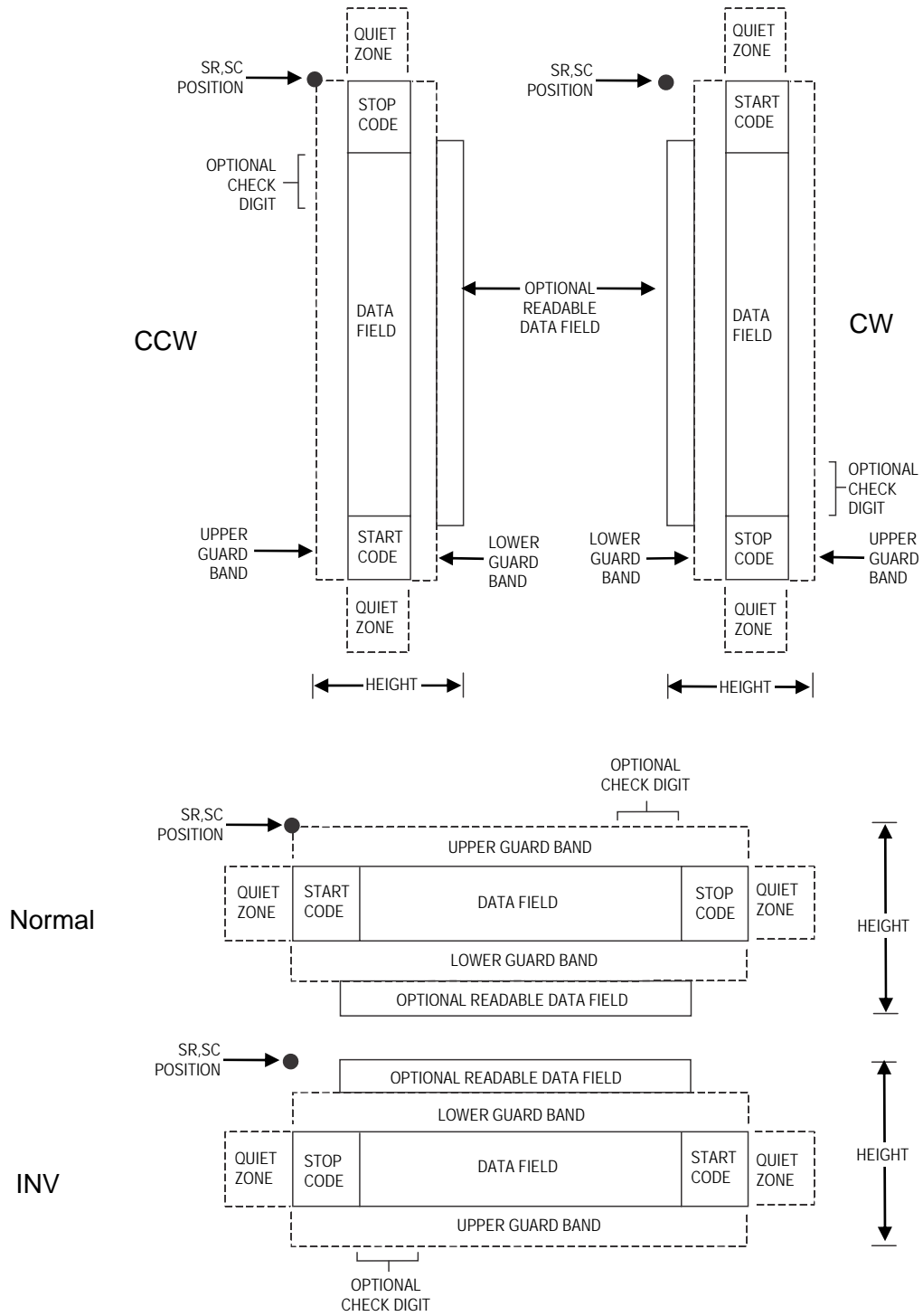

Figure 41 Plessey Structure

Quiet Zone

Both ends of the bar code structure require blank quiet zones. The quiet zones must be at least 0.25-inches wide and completely blank to ensure accurate reading of the start/stop codes and to prevent adjacent bar codes from overlapping. You must provide sufficient space on the form for the quiet zones.

Start/Stop Code

Unique start and stop codes permit bidirectional scanning. Both start and stop codes contain bars and spaces. They are automatically produced.

Data Field

The bar code symbol uses a series of wide and narrow bars and spaces to represent each character. The structure is four wide elements (bars or spaces) and four narrow elements. Each character contains four data bits, with each 0-bit made up of a narrow bar/wide space arrangement and each 1-bit made up of a wide bar/narrow space arrangement.

Readable Data

The optional readable data field provides a readable interpretation of the bar code data. It can be printed above or below the bar code symbol.

Check Digit

If specified, a "logical division" check digit is automatically calculated and inserted in the bar code symbol. The check digit verifies accurate scanning.

Plessey Command Format

```
BARCODE  
PLESSEY;[DIR;] [MAG;] [Hn[.m];] [BFn;L;] [DARK;] SR; SC  
[(D)data field(D)]  
[PDF [;LOC] [;FONT]]  
STOP
```

BARCODE	The Bar Code command; enter BARCODE .
PLESSEY	Designates bar code type Plessey; enter PLESSEY .
DIR	Optional parameter that allows for rotating a barcode. Enter CW for clockwise rotation. Enter CCW or VSCAN for counter-clockwise rotation. Enter INV for inverted rotation. If <i>DIR</i> is not entered, the barcode is horizontally oriented.
MAG	Optional parameter to magnify (horizontally expand) the bar code symbol. The magnification default value is X1 . As required for scanning, enter a magnification value from Table 12, page 106 or Table 13, page 107, depending on your printers tip size to increase the magnification. Increasing the magnification adjusts printed character density.

NOTE: You must specify four digits for MAG for User Defined variable ratio. There are four values that comprise the dot ratio: narrow bar, narrow space, wide bar, and wide space. User-defined ratios for this barcode should have these four values defined in the order specified.

Hn[.m]	Optional parameter to adjust the overall height (vertical expansion) of the bar code symbol (including the upper and lower 0.1-inch guard bands and any human readable data). Height adjustments are made in 0.1-inch increments; enter H and a value from 3 through 99 to select height adjustments from 0.3 through 9.9 inches. The default value is 0.9-inch. The [.m] provides an additional number of dots for the bar code height. (Dots are in the current dot scale.)
--------	--

NOTE: If 0.3 inches is the selected height, the PDF cannot be included.

<i>BFn;L</i>	<p>Optional parameters for assigning a dynamic bar code data field location on a form and for designating the length of the data field. With these parameters, the actual data for the bar code data field is dynamically provided during the Execute Form mode; the data is not specified during the Create Form mode. To use this field:</p> <ol style="list-style-type: none">Enter BF.Replace <i>n</i> with a number ranging from 0 through 512 to identify the bar code field. The <i>SR</i> and <i>SC</i> parameters specify the exact location of the bar code field identified by <i>n</i>.Replace <i>L</i> with a number equaling the total number of characters in the field. (The actual data provided dynamically during the Execute Form mode can be less than <i>L</i>.)The information for the data field is entered dynamically during the Execute Form mode. (Refer to Execute Form: Dynamic Bar Code Data on page 62.) Do not use the <i>data field</i> parameter to enter data when the <i>BFn;L</i> parameters are used. However, refer to the <i>data field</i> description for available characters.
DARK	<p>Optional parameter to produce darker looking bar codes. Enter DARK. Refer to Dark Printing on page 52 for more information.</p>
<i>SR</i>	<p>Defines the starting row for the bar code. Enter a value ranging from row 1 to one less than the length of the form. Character row or dot row is specified based on the Scale command (page 95), or use the CP.DP format (page 24).</p>
<i>SC</i>	<p>Defines the starting column of the bar code. Enter a value ranging from column 1 to one less than the width of the form. Character column or dot column is specified based on the Scale command (page 95), or use the CP.DP format (page 24).</p>
<i>(D)</i>	<p>The printable character (delimiter) identifying the start and finish of the data field. Enter any printable character other than a slash (/), the SFCC, or a character used within the data. The same character must be used at both ends of the data field, but it will not print with the data.</p>
<i>data field</i>	<p>Enter the characters for the bar code data. A null data field (no characters) is permitted. The length of the data field is variable; however, a maximum of 16 data characters is allowed. The characters available for the data field are 0 through 9 and A through F (hex 30 through 39).</p>
PDF	<p>Optional parameter to enable printing of the human readable data field. Enter PDF to print the data field. If the parameter is not used, the human readable data will not print.</p>
<i>LOC</i>	<p>Optional parameter to identify the location of the printable data field. The default value is B, locating the human readable data below the bar code. A locates the printable data field above the bar code. To compensate for printing the 0.1-inch high data, the height of the bar code body is reduced 0.1-inch.</p>

FONT Optional parameter to select the font for the human readable data field. Enter **O** to select OCR-A font; enter **X** to select OCR-B font; enter **N** to select 10 cpi; enter **P** to select 12 cpi; enter **Q** to select 13 cpi; enter **R** to select 15 cpi; enter **T** to select 17 cpi; enter **V** to select 20 cpi.

To select a scalable font with user-defined size, enter **Nh:w** or **F;Nh:w**. The parameters h (height) and w (width) can each range from 1 to 96, and are expansion factors of a 10 cpi character. Nh:w prints in Letter Gothic (font 93779) regardless of the current active font. By default F;Nh:w uses the Letter Gothic as the current font selection. You can change the default by using the FONT command.

NOTE: Nh:w and F;Nh:w will not print the PDF wider or taller than the barcode. If the height parameter h causes the PDF to print above the horizontal barcode start row or vertical barcode start column, a barcode font Error will occur. If the width parameter w causes the PDF to exceed the barcode width, the PDF width factor w will automatically reduce to fit within the barcode width without causing an error.

STOP Ends the Bar Code command while the IGP/PGL continues in the Create Form mode. Enter **STOP**. If STOP is not entered, an error message results.

Plessey Example

Figure 42 illustrates a horizontal and vertical Plessey bar code generated by the following program:

```
~CREATE;PLESSEY(Enter Create Form mode)
BARCODE(Bar Code command)
PLESSEY;DARK;32;27(Dark Bar Code PLESSEY at SR 32, SC 27)
*24688642*(Data Field)
PDF;X(Printable Data Field, OCR-B)
STOP(Ends Bar Code command)
BARCODE(New Bar Code command)
PLESSEY;VSCAN;X2;H12;DARK;32;54
(Vert. Dark PLESSEY, Mag 2, H 1.2 at SR 32, SC 54)
*24688642*(Data Field)
PDF;A (Upper Data Field)
STOP (Ends Bar Code command)
END(Terminates Create Form mode)
~EXECUTE;PLESSEY;1(Execute the form, form count of 1)
```

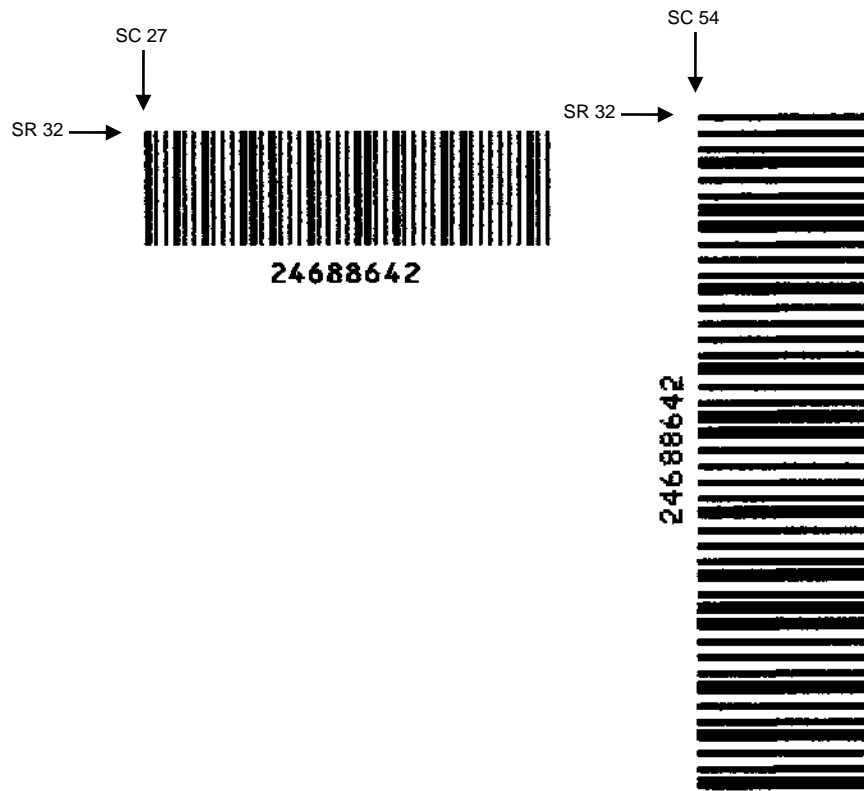
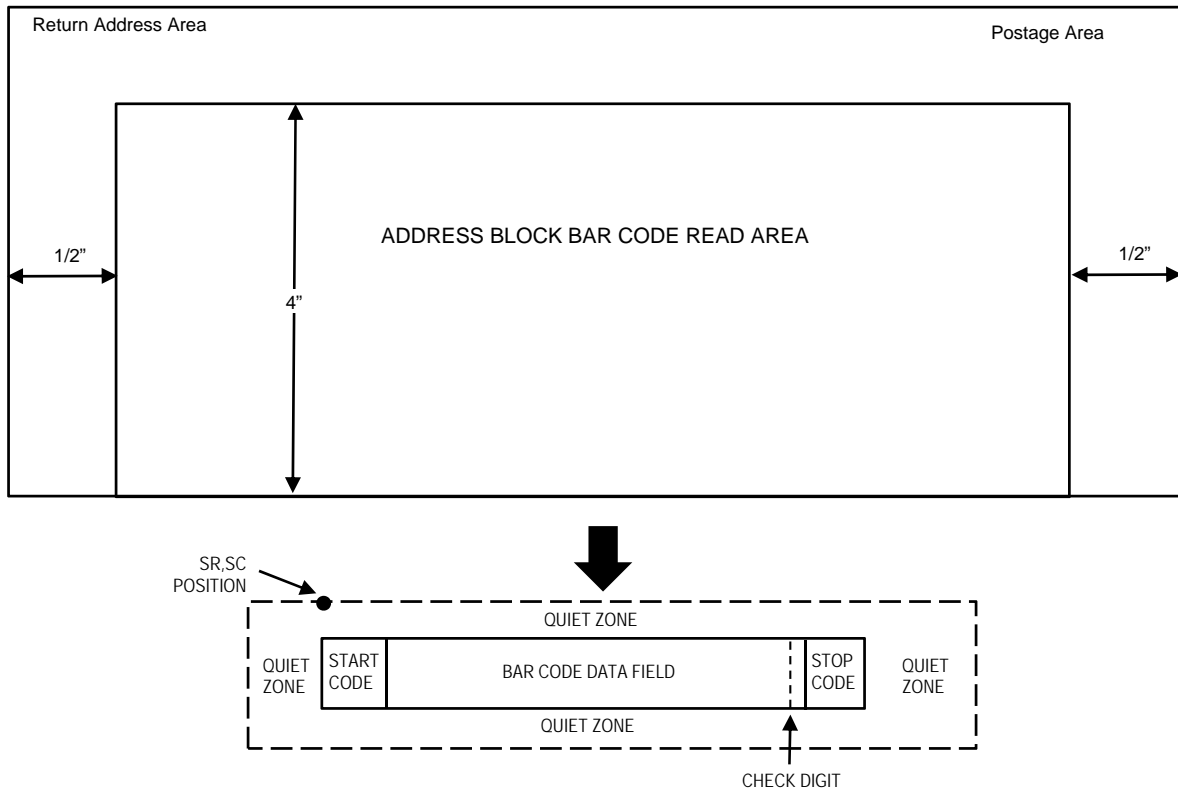

Figure 42 Sample Plessey Bar Codes

POSTNET

The POSTNET bar code structure is illustrated in Figure 43 and Figure 44 and described on the following pages. The POSTNET code can be a part of the address block and appear anywhere within a vertical 4-inch area across the length of the mail piece.



NOTE: Illustration is not to scale

Figure 43 POSTNET Structure

NOTE: Additional information regarding POSTNET bar code requirements can be obtained from the U.S. Postal Service's Publication 25: *A Guide to Business Mail Preparation*.

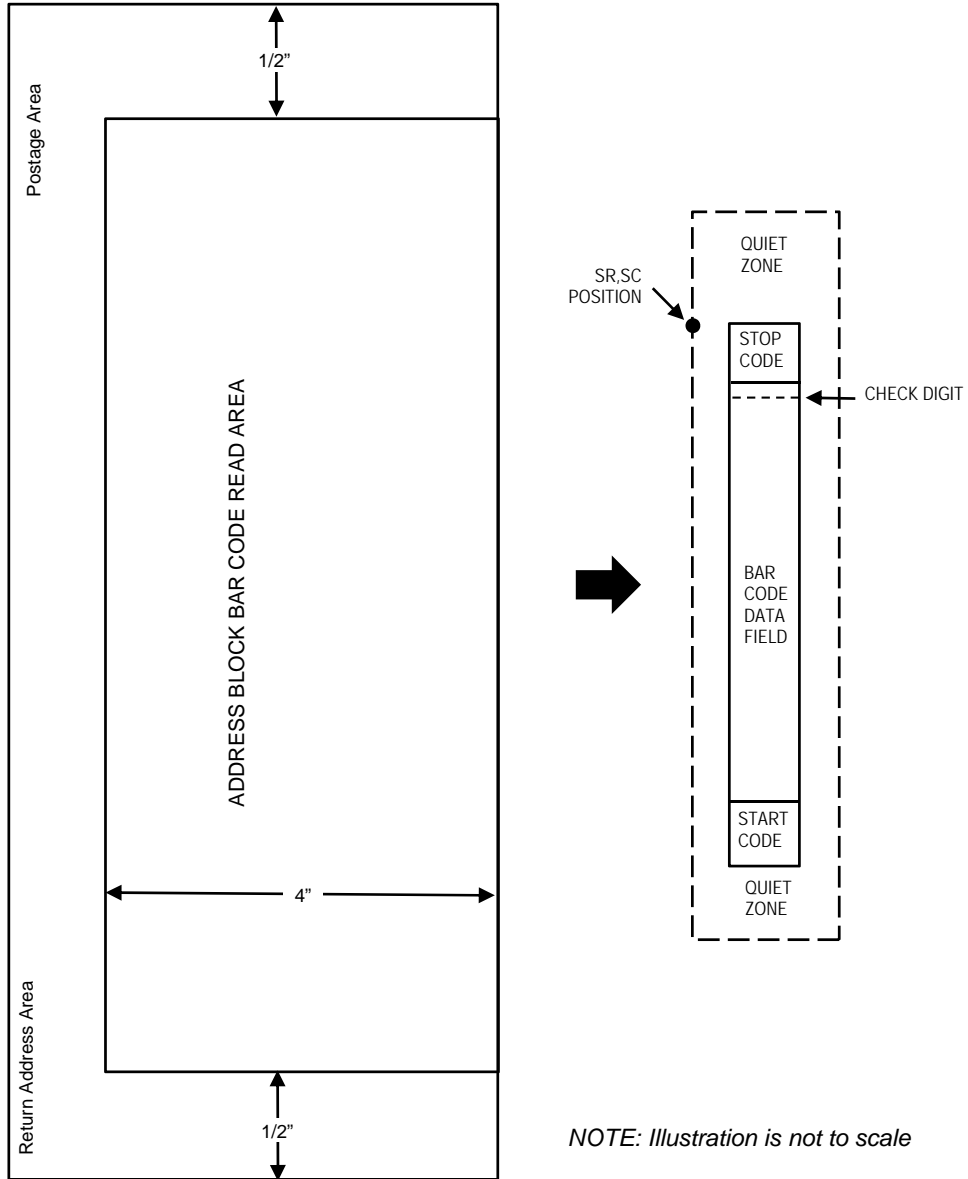

Figure 44 POSTNET Structure (VSCAN or CCW)

Quiet Zone

The bar code structure requires a completely blank quiet zone which extends 4.75 inches from the right edge of the mail piece. In addition, a minimum quiet zone of 0.040-inch above and below the bar code data must also be provided. You must provide sufficient space for this zone.

Start/Stop Code

The start and stop codes are referred to as “framing bars” in POSTNET. The start and stop codes are each one tall bar, one identifying the leading and trailing end of the bar code. The start/stop code is automatically produced with each bar code. The start/stop code structure permits bar code scanning in a left-to-right direction only.

Data Field

The bar code data produces a single field of 30 bars for a 5-digit field, 50 bars for a 9-digit data field, or 60 bars for an 11-digit data field. The bars are grouped in sets of five. Each set of five bars (comprised of two tall bars and three short bars) represents one of the five digits of the zip code, plus the four-digit zip code extension. If the Advanced Bar Code is used, an additional two-digit code is also added to make an 11-digit data field.

Each bar width is equal, and must be .020-inch \pm .005-inch. Each bar height is either a tall (full) or short (half) bar, representing a 1 or 0, respectively. Each tall bar must be .125-inch \pm .010-inch; each short bar must be .050-inch \pm .010-inch. Horizontal spacing between bars (pitch) must be 22 bars \pm 2 bars per inch over any 0.50-inch portion of the bar code. Horizontal spacing at 24 and 20 bars per inch is 0.0416-inch and .050-inch, respectively, with a clear vertical space ranging from 0.012-inch to 0.040-inch between bars.

Check Digit

The sixth, tenth or twelfth digit represents the automatic check digit character for the 5, 9 or 11-digit data field, respectively. The check digit is added automatically to verify accurate scanning.

POSTNET Command Format

BARCODE
POSTNET; [*DIR*]; [*NLQ*]; [*BF n ;L*]; [*DARK*]; *SR*; *SC*
(*D*)*data field(D)*
STOP

BARCODE	The Bar Code command; enter BARCODE .
POSTNET	Designates bar code type POSTNET; enter POSTNET .
<i>DIR</i>	Optional parameter that allows for rotating a barcode. Enter CW for clockwise rotation. Enter CCW or VSCAN for counter-clockwise rotation. Enter INV for inverted rotation. If <i>DIR</i> is not entered, the barcode is horizontally oriented.
NLQ	Optional parameter optimized to print barcodes at NLQ print density (180x96). This may cause line matrix printers to reverse motion when the form prints. This parameter is ignored for other printer types.
<i>BFn;L</i>	Optional parameters for assigning a dynamic bar code data field location on a form and for designating the length of the data field. With these parameters, the actual data for the bar code data field is dynamically provided during the Execute Form Mode; the data is not specified during the Create Form Mode. To use this field, perform the following steps: <ol style="list-style-type: none">Enter BF.Replace <i>n</i> with a number ranging from 0 through 512 to identify the bar code field. The <i>SR</i> and <i>SC</i> parameters specify the exact location of the bar code field identified by <i>n</i>.

- c. Replace *L* with a number equaling the total number of characters in the field. The data field must be numeric and contain exactly 5, 9 or 11 digits. (The actual data provided dynamically during the Execute Form Mode can be less than *L*.)
- d. The information for the data field is entered dynamically during the Execute Form Mode. (Refer to Execute Form: Dynamic Bar Code Data on page 62.) Do not use the *data field* parameter to enter data when the *BF_n;L* parameters are used. However, refer to the *data field* description for available characters.

DARK	Optional parameter to produce darker looking bar codes. Enter DARK . Refer to Dark Printing on page 52 for more information.
SR	Defines the starting row for the bar code. Enter a value within the range of the 4-inch vertical address block. Character row or dot row is specified based on the Scale command (page 95), or use the CP.DP format (page 24).
SC	Defines the starting column of the bar code. Enter a value between the 1/2-inch left and right margins of the mail piece. Character column or dot column is specified based on the Scale command (page 95), or use the CP.DP format (page 24).
(D)	The printable character (delimiter) identifying the start and finish of the data field. Enter any printable character other than a slash (/) the SFCC, or a character used within the data. The same character must be used at both ends of the data field but it will not print with the data.
<i>data field</i>	The bar code data. Enter 5 digits (for zip code), 9 digits for a nine-digit zip code, or 11 digits (for the Delivery Point Bar Code format). The available characters for the data field are 0 through 9 (hex 30 through 39).
STOP	Ends the Bar Code command while the IGP continues in the Create Form Mode. Enter STOP . If STOP is not entered, an error message will result.

POSTNET Example

Figure 45 illustrates a horizontal and vertical POSTNET bar code generated by the following program:

```
~CREATE;POSTNET          (Enter Create Form Mode)
BARCODE                  (Bar code command)
POSTNET;DARK;10;40      (Dark POSTNET bar code at SR 10, SC 40)
*601159912*            (ZIP + 4 data field 60115-9912)
STOP                     (Ends Bar Code command)
END                      (Terminates Create Form Mode)
~CREATE;POSTNET          (Enter Create Form Mode)
BARCODE                  (Bar code command)
POSTNET;VSCAN;DARK;10;20 (Dark Vertical bar code POSTNET at SR 10,
                        SC 40)
*601159912*            (ZIP + 4 data field 60115-9912)
STOP                     (Ends Bar Code command)
END                      (Terminates Create Form Mode)
~EXECUTE;POSTNET;1      (Execute the form, with form count of 1)
~NORMAL
```

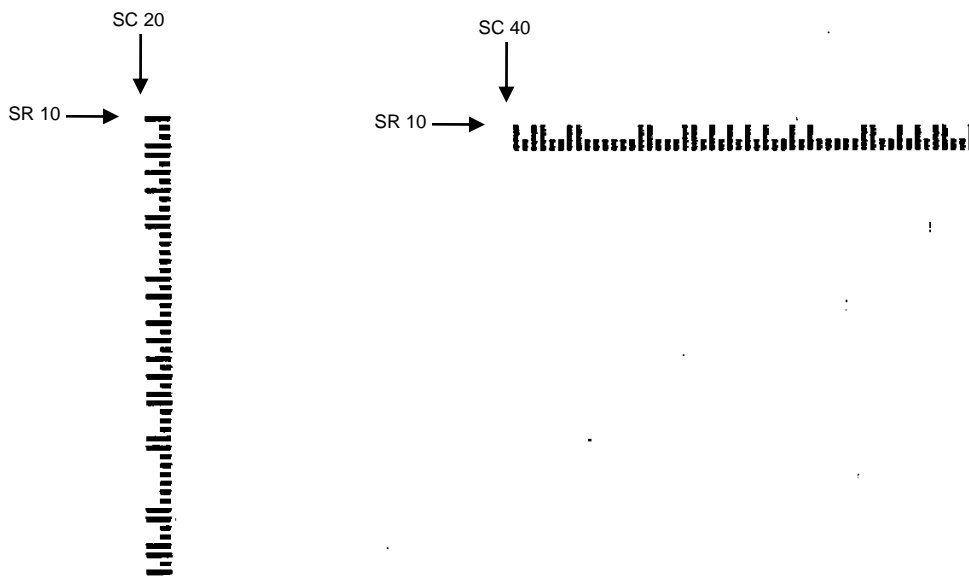

Figure 45 Sample POSTNET Bar Code

PostBar and Royal Mail (KIX)

PostBar and Royal Mail bar codes, like POSTNET, are used for mailing applications. However, these bar codes can encode full addresses on labels. These bar codes are similar to POSTNET in terms of bar space and width, but have four different types of bars (Full Height, Ascender, Descender, and Tracker), whereas POSTNET only has two bar types (Tall and Short).

The Royal Mail symbology converts alphanumeric characters into patterns of four bars, using combinations of Full Height, Ascender, Descender, and Trackers. It also adds start and stop bar codes as well as a check digit, except with the KIX format (see below).

PostBar allows you complete flexibility to specify the individual bar types that comprise the bar code. For PostBar, you are responsible for encoding the address, adding the start and stop codes, and supplying the appropriate check digit.

Quiet Zone

The bar code structure requires a completely blank quiet zone which is a 2mm border on each side of the bar code.

Start/Stop Code

The start and stop bars identify the orientation of the bar code.

Data Field

For PostBar, a variable length data field of digits "0" through "3" are allowed to represent the bars: Full Height (0), Ascender (1), Descender (2), and Tracker (3). For Royal Mail, the data is restricted to alphanumeric characters "A" through "Z" and "0" through "9". If using the KIX format for Royal Mail, lowercase characters "a" through "z" are also valid.

Each bar width is equal, and must be .020-inch \pm .005-inch. Horizontal spacing between bars (pitch) must be 22 bars \pm 2 bars per inch over any 0.50- inch portion of the bar code. The height of the bars (Full Height) has a maximum of 0.230 inches and a minimum of 0.165 inches.

Check Digit

For PostBar, you are responsible for encoding and check digit. For Royal Mail, a modulo-6 check digit is inserted at the end of the data field.

KIX Format

The KIX format for Royal Mail does not include the start/stop code or the check digit.

PostBar and Royal Mail Command Format

BARCODE

POSTBAR or ROYALBAR; [KIX;][NLQ;][MAG;][BFn;L;][DARK;]

SR; SC (D)data field(D)

STOP

BARCODE The Bar Code command; enter **BARCODE**.

POSTBAR or ROYALBAR

Designates bar code type PostBar or Royal Mail; enter **POSTBAR** or **ROYALBAR**.

KIX Optional parameter to specify the KIX format for Royal Mail bar codes only; enter **KIX**.

NLQ Optional parameter optimized to print barcodes at NLQ print density (180x96). This may cause line matrix printers to reverse motion when the form prints. This parameter is ignored for other printer types.

MAG Optional parameter to magnify (horizontally expand) the bar code symbol. The magnification default value is **X1**. As required for scanning, enter a magnification value to increase the magnification. Increasing the magnification adjusts printed character density. **X1A** uses shorter bars to reach the minimum height specification that allows it to fit on a 6 LPI line.

NOTE: The User Defined variable ratio is not allowed for this barcode.

BF n ;L Optional parameters for assigning a dynamic bar code data field location on a form and for designating the length of the data field. With these parameters, the actual data for the bar code data field is provided dynamically during the Execute Form mode; the data is not specified during the Create Form mode. To use this field, perform the following steps:

- a. Enter **BF**.
- b. Replace n with a number ranging from **0 through 512** to identify the bar code field. The *SR* and *SC* parameters specify the exact location of the bar code field identified by n .
- c. Replace L with a number equaling the total number of characters in the field. (The actual data provided dynamically during the Execute Form Mode can be less than L .)
- d. The information for the data field is entered dynamically during the Execute Form mode. (Refer to Execute Form: Dynamic Bar Code Data on page 62.) Do not use the *data field* parameter to enter data when the **BF n ;L** parameters are used. However, refer to the *data field* description for available characters.

DARK Optional parameter to produce darker looking bar codes. Enter **DARK**. Refer to Dark Printing on page 52 for more information.

SR Defines the starting row for the bar code. Character row or dot row is specified based on the Scale command (page 95), or use the CP.DP format (page 24).

SC Defines the starting column of the bar code. Character column or dot column is specified based on the Scale command (page 95), or use the CP.DP format (page 24).

(D) The printable character (delimiter) identifying the start and finish of the data field. Enter any printable character other than a slash (/) the SFCC, or a character used within the data. The same character must be used at both ends of the data field but it will not print with the data.

data field The bar code data. For PostBar, enter values **0 through 3** to represent the four different types of bars. For Royal Mail, enter alphanumeric data (**A through Z** and **0 through 9**). If using the KIX format for Royal Mail, lowercase characters **a through z** are also valid.

STOP Ends the Bar Code command while the IGP continues in the Create Form Mode. Enter **STOP**. If **STOP** is not entered, an error message will result.

PostBar and Royal Mail Examples

Figure 46 illustrates a horizontal Royal Mail bar code generated by the following program:

```
~CREATE;ROYALBAR          (Enter Create Form Mode)
BARCODE                  (Bar Code command)
ROYALBAR;X1A;10;40      (Royal Mail bar code at SR 10, SC 40 with
                        MAG 1A)
*SN34RD1A*             (Data Field)
STOP                    (Ends Bar Code command)
END                     (Terminates Create Form Mode)
~EXECUTE;ROYALBAR;1     (Execute the form, with form count of 1)
~NORMAL
```

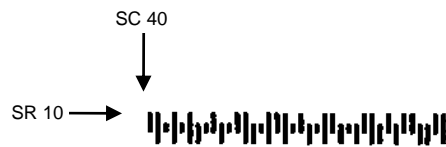

Figure 46 Sample Royal Mail bar code (X1A Magnification)

Figure 47 illustrates a horizontal PostBar bar code generated by the following program:

```
~CREATE;POSTBAR          (Enter Create Form Mode)
BARCODE                  (Bar Code command)
POSTBAR;10;40           (PostBar bar code at SR 10, SC 40
                        with default MAG 1)
*10303023123102301031230123210212112210* (Data Field)
STOP                    (Ends Bar Code command)
END                     (Terminates Create Form Mode)
~EXECUTE;POSTBAR;1     (Execute the form, with form count of 1)
~NORMAL
```

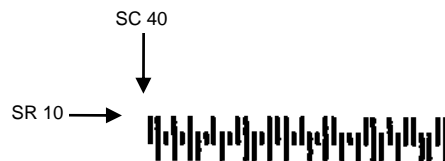

Figure 47 Sample PostBar bar code (X1 Magnification)

QR Barcode

The QR code is a two dimensional general purpose matrix bar code. QR encodes Kanji characters and is a popular symbology in Japan. QR code symbols are square and can be identified by their finder pattern of nested alternating light and dark squares. The QR code is omni-directional and is designed for high speed reading. This bar code is capable of storing up to 7,089 numeric digits, 4,296 alphanumeric characters, 2,953 binary characters, or 1817 Kanji characters in Automatic mode. The data limit may be less if Manual mode is used. If the data to encode is too large to fit in one bar code, the data can be split up and encoded in up to 16 QR bar codes.

Command Format

BARCODE

QRCODE; [DIR;] [X[D]n;] [Y[D]n;] [Tn;] [En;] [Mn;] [In;] [Cn;Pn; Nn; Rn;]
[BFn;L;] [DARK;] SR; SC
[(D)Data Field(D)]

STOP

Parameter Description

QRCODE	Designates bar code type QR Code
DIR	Optional parameter that allows for rotating a bar code. Enter CW for clockwise rotation. Enter CCW or VSCAN for counter clockwise rotation. Enter INV for inverted rotation. If DIR is not entered, the bar code is horizontally oriented.
X[D]n	Optional parameter that designates the x dimension width of a single square data module in IGP dots, or printer dots if option [D] is used. Values range from 1 to 1000 printer dots. If the Y[D]n is not used, then the y dimension is calculated by converting the printer dots in the x direction to printer dots in the y direction.
Y[D]n	Optional parameter that designates the y dimension height of a single square data module in IGP dots, or printer dots if option [D] is used. Values range from 1 to 1000 printer dots. If the X[D]n is not used, then the x dimension is calculated by converting the printer dots in the y direction to printer dots in the x direction.
Tn	Optional parameter that designates the QR code model. There are three models of QR code: Model 1 is the original model developed. Model 2 is an enhanced form of the symbology. Model 3 or Micro QR is a compact version of the symbology. Set T to the following variables depending on the selected model: 1 = Model 1 2 = Model 2 (default) 3 = Micro QR
En	Optional parameter that designates the error correction capabilities of the bar code. There are four levels of error correction available. 0 = High density (Level L) which provides 7% error correction capability. 1 = Standard (Level M) which provides 15% error correction capability. 2 = High reliability (Level Q) which provides 25% error correction capability.

3 = Super high reliability (Level H) which provides 30% error correction capability.

The default error correction capability is standard (Level M) which provides 15% error correction capability.

Mn Optional parameter that designates the masking pattern to apply to the bar code data. Applying a masking pattern to the data can improve the readability of the bar code because it can help create a more evenly balanced number of light and dark cells. Valid settings for the masking patterns are as follows:

0 = No Mask (default) 1 = Mask Pattern 1

2 = Mask Pattern 2

3 = Mask Pattern 3

4 = Mask Pattern 4

5 = Mask Pattern 5

6 = Mask Pattern 6

7 = Mask Pattern 7

8 = Mask Pattern 8

ln Optional parameter that designates the data entry method. There are two data entry methods: Automatic and Manual. The following values specifies the data entry method:

0 = Automatic (default)

1 = Manual

In automatic data entry mode, the data type is automatically determined along with the appropriate block division. The maximum block division is 200 characters. In manual data entry mode, the user must specify the data type and each data block must contain 200 characters or less.

Multiple data blocks must be separated by a comma character (","). To use manual data entry mode, perform the following steps:

1. Enter I1
2. In the bar code data section, enter the bar code data with one of the following type preface:
 - A = Alphanumeric
 - N = Numeric
 - Bxxxx = Binary. The total number (a decimal of 4 columns) of binary characters must be specified.
 - K = Kanji character

Example

AAC-42, N0123456, B0006qrcode

The above data is parsed as follows:

- 3 data blocks
- First data block is alphanumeric: AC-42
- Second data block is numeric: 0123456
- Third data block is binary: qrcode (6 bytes)

Cn Optional parameter that designates the use of concatenation. If the data to be encoded is too large to fit in one bar code, the data can be split up and encoded in multiple bar codes. Up to 16 QR bar codes can be used

to store a single data. When data is split among multiple QR codes, the total number of bar codes or partitions must be specified, along with the sequence number of each partition. A parity data is provided to ensure that the data has been properly concatenated. The valid values for concatenation mode are as follows:

0 = Normal, no concatenation (default)

1 = Concatenation

<i>Nn</i>	Required parameter for concatenation mode that specifies the partition sequence number for this bar code. The valid value for this parameter is 1 to 16.
<i>Pn</i>	Required parameter for concatenation mode that specifies the total number of bar code partitions. The valid value for this parameter is 1 to 16.
<i>Rn</i>	Required parameter for concatenation mode that specifies the parity data for the original bar code data. The value is a single byte hex number ranging from 0x00 to 0xFF. Enter the hex number using 2 ASCII characters. Enter the hex number using 2 ASCII characters.
Example:	The parameters C1;N1;P5;R0f specify that concatenation mode is enabled. This bar code is the first one in the sequence of 5 bar codes and the original data has a parity of 0x0F.
<i>BFn;L</i>	Optional parameters for assigning a dynamic bar code data field location on a form and for designating the length of the data field. With these parameters, the actual data for the bar code data field is dynamically provided during the Execute Form Mode; the data is not specified during the Create Form Mode. To use this field, perform the following steps: <ol style="list-style-type: none">Enter BF.Replace <i>n</i> with a number ranging from 0 through 512 to identify the bar code field. The SR and SC parameters specify the exact location of the bar code field identified by <i>n</i>.Replace <i>L</i> with a number equaling the total number of characters in the field. (The actual data provided dynamically during the Execute Form Mode can be less than <i>L</i>.)The information for the data field is entered dynamically during the Execute Form Mode. Do not use the data field parameter to enter data when the <i>BFn;L</i> parameters are used. However, refer to the data field description for available characters.
DARK	Optional parameter to produce darker looking bar codes. Enter DARK. Refer to Dark Printing for more information.
SR	Defines the starting row for the bar code. Enter a value ranging from row 1 to one less than the length of the form. Character row or dot row is specified based on the Scale command or the CP.DP format.
SC	Defines the start column of the bar code. Enter a value ranging from column 1 to one less than the width of the form. Character column or dot column is specified based on the Scale command, or use the CP.DP format.
(D)	The printable character (delimiter) identifying the start and finish of the data field. Enter any printable character other than a slash (/), the SFCC, or a character used within the data. The same character must be used at both ends of the data field, it will not print with the data.

Quiet Zone

In the minimum quiet zone is four cells width on all four sides.

GuardBand

There are no guardbands for QR Code.

PDF

There is no PDF allowed for the QR Code.

Data Field

This bar code is capable of storing up to 7,089 numeric digits, 4,296 alphanumeric characters, or 2,953 binary characters in Automatic mode. The maximum data block division is 200 characters. Multiple data block must be separated by a comma character (“,”). In manual data entry mode, a data type identifier must precede each data block. If the data type is binary, a four digit length value must follow immediately after the data type identifier. The following are valid data type identifiers:

- A = Alphanumeric
- N = Numeric
- B = Binary.

The maximum character size for the different barcode models is listed in the table below. This limit is based on Automatic mode. In Manual mode, the maximum character size may be less.

Type	QR code Model 1	QR Code Model 2	MicroQR
Numeric	Max. 1167 characters	Max. 7089 characters	Max. 35 characters
Alphanumeric	Max. 707 characters	Max. 4296 characters	Max. 21 characters
Binary 8-bit bytes	Max. 486 characters	Max. 2953 characters	Max. 15 characters

Telepen

The Telepen structure is shown in Figure 48 and described on the following pages.

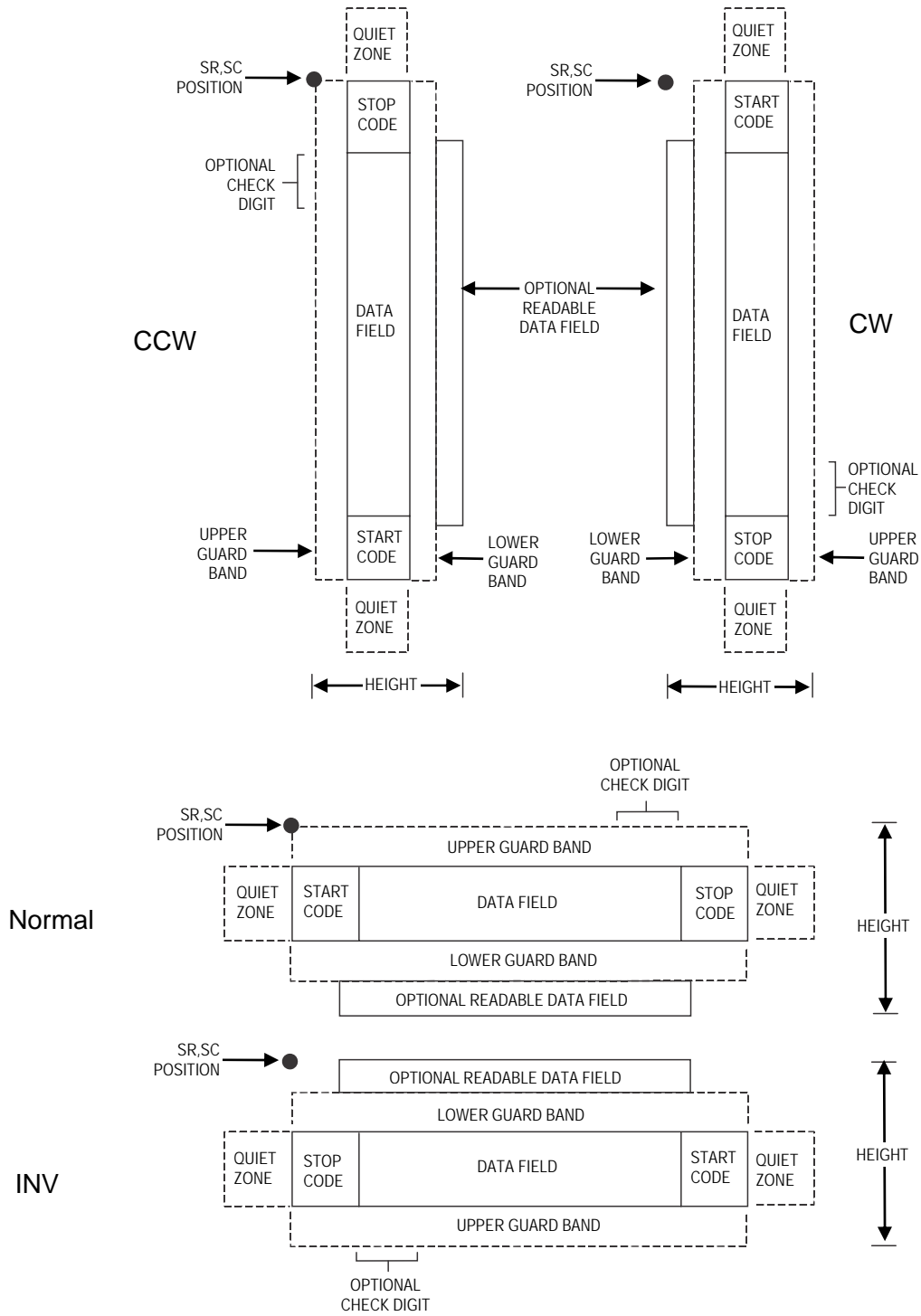

Figure 48 Telepen Structure

Quiet Zone

Both ends of the bar code structure require blank quiet zones. The quiet zones must be at least 0.25 inches wide and completely blank to ensure accurate reading of the start/stop codes and to prevent adjacent bar codes from overlapping. Be sure to provide sufficient space on the form for the quiet zones.

Start/Stop Codes

The start/stop code is a unique character identifying the leading and trailing end of the bar code. The start/stop code is automatically produced with each bar code. The start/stop code structure permits bidirectional bar code scanning.

Data Field

The bar code symbol uses a series of wide and narrow bars and spaces to represent standard alphanumeric characters. Each character is represented by a different series of bars and spaces, both wide and narrow, but is always 16 units in width (for a wide to narrow ratio of 3). Each character starts with a bar and ends with a space.

Readable Data

The optional readable data field provides a readable interpretation of the bar code data. It can be printed above or below the bar code symbol.

Check Digit

A mandatory modulo-127 check digit is inserted into the bar code to verify accurate scanning.

Telepen Command Format

BARCODE
TELEPEN; [DIR;] [MAG;] [Hn[.m];] [BFn;L;] [DARK;] SR; SC
(D) [data field] (D)
[PDF [;LOC] [;FONT]]
STOP

BARCODE	The Bar Code command; enter BARCODE .
TELEPEN	Designates bar code type Telepen; enter TELEPEN .
DIR	Optional parameter that allows for rotating a barcode. Enter CW for clockwise rotation. Enter CCW or VSCAN for counter-clockwise rotation. Enter INV for inverted rotation. If <i>DIR</i> is not entered, the barcode is horizontally oriented.
MAG	Optional parameter to magnify (horizontally expand) the bar code symbol. The magnification default value is X1 . As required for scanning, enter a magnification value from Table 12, page 106 or Table 13, page 107, depending on your printers tip size to increase the magnification. Increasing the magnification adjusts printed character density. You can also use XR or XRD as defined on page 104.

NOTE: You must specify four digits for MAG for User Defined variable ratio. There are four values that comprise the dot ratio: narrow bar, narrow space, wide bar, and wide space. User-defined ratios for this barcode should have these four values defined in the order specified.

Hn[.m]	Optional parameter to adjust the overall height (vertical expansion) of the bar code symbol (including the upper and lower 0.1-inch guard bands and any human readable data). Height adjustments are made in 0.1-inch increments plus dots; enter H and a value from 3 through 99 to select height adjustments from 0.3 through 9.9 inches. The default value is 0.9 inch. [.m] is an additional number of dots for the bar code height. (Dots are in the current dot scale.)
--------	--

NOTE: If 0.3 inches is the selected height, the PDF cannot be included.

<i>BFn;L</i>	Optional parameters for assigning a dynamic bar code data field location on a form and for designating the length of the data field. With these parameters, the actual data for the bar code data field is dynamically provided during the Execute Form Mode; the data is not specified during the Create Form Mode. To use this field, perform the following steps: <ol style="list-style-type: none">Enter BF.Replace <i>n</i> with a number ranging from 0 through 512 to identify the bar code field. The <i>SR</i> and <i>SC</i> parameters specify the exact location of the bar code field identified by <i>n</i>.Replace <i>L</i> with a number equaling the total number of characters in the field. (The actual data provided dynamically during the Execute Form Mode can be less than <i>L</i>.)The information for the data field is entered dynamically during the Execute Form Mode. (Refer to Execute Form: Dynamic Bar Code Data on page 62.) Do not use the <i>data field</i> parameter to enter data when the <i>BFn;L</i> parameters are used. However, refer to the <i>data field</i> description for available characters.
DARK	Optional parameter to produce darker looking bar codes. Enter DARK . Refer to Dark Printing on page 52 for more information.
<i>SR</i>	Defines the starting row for the bar code. Enter a value ranging from row 1 to one less than the length of the form. Character row or dot row is specified based on the Scale command (page 95), or use the CP.DP format (page 24).
<i>SC</i>	Defines the starting column of the bar code. Enter a value ranging from column 1 to one less than the width of the form. Character column or dot column is specified based on the Scale command (page 95), or use the CP.DP format (page 24).
<i>(D)</i>	The printable character (delimiter) identifying the start and finish of the data field. Enter any printable character other than a slash (/), the SFCC, or a character used within the data. The same character must be used at both ends of the data field, but it is not printed with the data.
<i>data field</i>	Contains the bar code characters. A null data field (no characters) is permitted. The data field can contain any of the characters listed in Table 37 except the SFCC. The length of the data field is variable; however, the maximum length is usually limited to 32 characters to minimize potential reading errors.
PDF	Optional parameter to enable printing of the human readable data field. Enter PDF to print the data field. If the parameter is not used, the human readable data will not print. This parameter is not allowed if a null data field is specified.
<i>LOC</i>	Optional parameter to identify the location of the printable data field. The default value is B , locating the human readable data below the bar code. A locates the printable data field above bar code. To compensate for printing the 0.1-inch high data, the height of the bar code body is reduced 0.1 inch.
<i>FONT</i>	Optional parameter to select the font for the human readable data field. Enter O to select OCR-A font; enter X to select OCR-B font; enter N to select 10 cpi; enter P to select 12 cpi; enter Q to select 13 cpi; enter R to select 15 cpi; enter T to select 17 cpi; enter V to select 20 cpi.

To select a scalable font with user-defined size, enter **Nh:w** or **F;Nh:w**. The parameters h (height) and w (width) can each range from 1 to 96, and are expansion factors of a 10 cpi character. Nh:w prints in Letter Gothic (font 93779) regardless of the current active font. By default F;Nh:w uses the Letter Gothic as the current font selection. You can change the default by using the FONT command.

NOTE: Nh:w and F;Nh:w will not print the PDF wider or taller than the barcode. If the height parameter h causes the PDF to print above the horizontal barcode start row or vertical barcode start column, a barcode font Error will occur. If the width parameter w causes the PDF to exceed the barcode width, the PDF width factor w will automatically reduce to fit within the barcode width without causing an error.

STOP Ends the Bar Code command while the IGP continues in the Create Form Mode. Enter **STOP**. If STOP is not entered, an error message results.

Table 37 Telepen Character Set

ASCII	Telepen	ASCII	Telepen	ASCII	Telepen	ASCII	Telepen
NUL	%U	SP	Space	@	%V	`	%W
SOH	\$A	!	/A	A	A	a	+A
STX	\$B	"	/B	B	B	b	+B
ETX	\$C	#	/C	C	C	c	+C
EOT	\$D	\$	/D	D	D	d	+D
ENQ	\$E	%	/E	E	E	e	+E
ACK	\$F	&	/F	F	F	f	+F
BEL	\$G	'	/G	G	G	g	+G
BS	\$H	(/H	H	H	h	+H
HT	\$I)	/I	I	I	i	+I
LF	\$J	*	/J	J	J	j	+J
VT	\$K	+	/K	K	K	k	+K
FF	\$L	,	/L	L	L	l	+L
CR	\$M	—	—	M	M	m	+M
SO	\$N	.	.	N	N	n	+N
SI	\$O	/	/O	O	O	o	+O
DLE	\$P	0	0	P	P	p	+P
DC1	\$Q	1	1	Q	Q	q	+Q
DC2	\$R	2	2	R	R	r	+R
DC3	\$S	3	3	S	S	s	+S
DC4	\$T	4	4	T	T	t	+T
NAK	\$U	5	5	U	U	u	+U
SYN	\$V	6	6	V	V	v	+V
ETB	\$W	7	7	W	W	w	+W
CAN	\$X	8	8	X	X	x	+X
EM	\$Y	9	9	Y	Y	y	+Y
SUB	\$Z	:	/Z	Z	Z	z	+Z
ESC	%A	:	%F	[%K	{	%P
FS	%B	<	%G	\	%L		%Q
GS	%C	=	%H]	%M	}	%R
RS	%D	>	%I	^	%N	~	%S
US	%E	?	%J	—	%O	DEL	%T %X %Y %Z

NOTE: Character pairs /M, /N, and /P through /Y are reserved for future control character pairs.

Telepen Example

Figure 49 illustrates a horizontal and vertical Telepen bar code generated by the following program:

```
~CREATE;TELEPEN          (Enter Create Form Mode)
BARCODE                  (Bar Code Command)
TELEPEN;5;5              (Telepen barcode at SR 5, SC 5)
" SAMPLE#1 "            (Data Field)
PDF;B                    (Printable Data Field)
STOP                     (Ends Bar Code Command)
BARCODE                  (New Bar Code Command)
TELEPEN;VSCAN;10;5      (Vertical Telepen barcode at SR 10, SC 5)
" AB12&&%"              (Data Field)
PDF;B                    (Printable Data Field)
STOP                     (Ends Bar Code Command)
END                       (Terminates Create Form Mode)
~EXECUTE;TELEPEN;1      (Execute the form, form count of 1)
~NORMAL
```

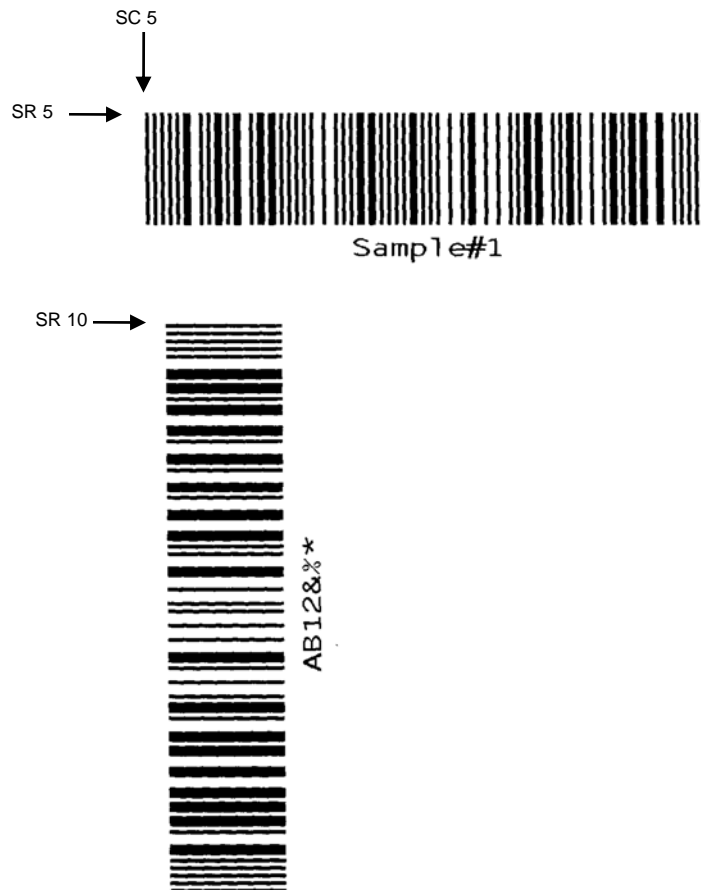

Figure 49 Sample Telepen Bar Codes

UPC-A

The UPC-A bar code structure is shown in Figure 50 and described on the following pages.

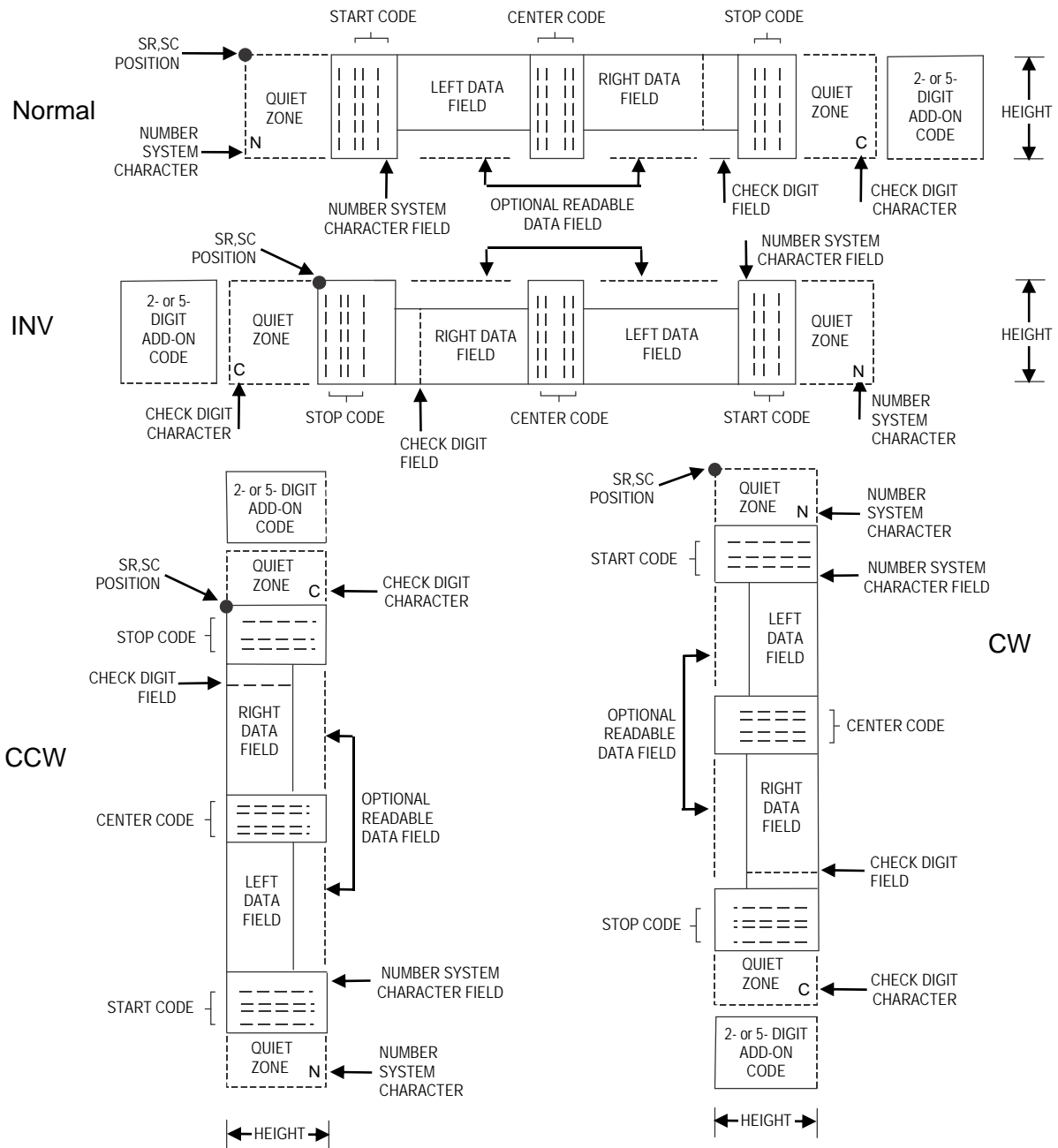

Figure 50 UPC-A Structure

Quiet Zone

Quiet zones extend on both ends of the bar code to permit the scan to begin and end in a blank area. The IGP automatically produces an 11-module wide left quiet zone; you are responsible for providing sufficient space (minimum of seven modules) on the form for the right quiet zone. The number system character is also printed automatically in the left quiet zone.

Start/Center/Stop Codes

The start/center/stop codes are special character codes marking those portions of the bar code. These codes are automatically provided.

Number System Character

The number system character field allows you to provide a code to a class or type of item. The first character in the data field is used as the number system character.

Data Field

The bar code symbol uses a series of varying width bars and spaces to represent a limited character set (numbers 0-9 and Special Characters Start, Center, and Stop). The bars and spaces vary in width from one through four modules. Each character consists of two bars and two spaces that total seven modules. The symbol coding of the left data field is different from the right data field to permit read direction sensing.

The optional 2- or 5-digit add-on data field is placed at the end of the bar code and typically identifies a periodical issue number or price, respectively.

Readable Data

The human readable data field provides a readable interpretation of the bar code data. It can either be suppressed or printed above or below the bar code symbol.

Check Digit

The modulo-10 check digit is automatically calculated and inserted in the bar code symbol. The check digit verifies accurate scanning. The number system character is included in the check digit algorithm.

UPC-A Command Format

BARCODE

UPC-A [*+n*]; [*DIR*]; [*SCB*]; [*MAG*]; [*Hn*].*m*]; [*BFn*]; [*DARK*]; *SR*; *SC*
(*D*)*data field*(*D*)
[*PDF* [; *LOC*] [; *FONT*]] *STOP*

BARCODE	The Bar Code command; enter BARCODE .
UPC-A	Designates bar code type UPC-A; enter UPC-A .
<i>+n</i>	Optional parameter to provide a 2- or 5-digit add-on code at the end of the bar code data field. Enter a plus sign (+) and a value of 2 or 5 . The first bar of the add-on code is separated by nine modules from the last bar of the UPC symbol and a left guard pattern.
<i>DIR</i>	Optional parameter that allows for rotating a barcode. Enter CW for clockwise rotation. Enter CCW or VSCAN for counter-clockwise rotation. Enter INV for inverted rotation. If <i>DIR</i> is not entered, the barcode is horizontally oriented.
SCB	This option shortens the length of the center guard bars, which are normally full length. Enter SCB .
<i>MAG</i>	Optional parameter to magnify (horizontally expand) the bar code symbol. The magnification default value is X1 . Enter a magnification

value from Table 12, page 106 or Table 13, page 107, depending on your printer's tip size to increase the magnification. Increasing the magnification adjusts printed character density. You can also use XR or XRD as defined on page 104. You must specify 8 digits for *MAG* for variable ratio.

NOTE: There are eight values that comprise the dot ratio: narrow bar, narrow space, 2x narrow bar, 2x narrow space, 3x narrow bar, 3x narrow space, 4x narrow bar, and 4x narrow space. User-defined ratios for this barcode should have these eight values defined in the order specified.

<i>Hn[m]</i>	Optional parameter to adjust the overall height (vertical expansion) of the bar code symbol (including the upper and lower 0.1-inch guard bands and any human readable data). Height adjustments are made in 0.1-inch increments; enter H and a value from 2 through 99 to select height adjustments from 0.2 through 9.9 inches. If any value less than 3 is selected, then the PDF must be suppressed using the PDF Font parameter S . The default value is 1.3 inches. [<i>m</i>] is an additional number of dots for the bar code height. (Dots are in the current dot scale.)
<i>BFn</i>	Optional parameter for assigning a dynamic bar code data field location on a form. With this parameter, the actual data for the bar code data field is dynamically provided during the Execute Form Mode; the data is not specified during the Create Form Mode. To use this field, perform the following steps: <ol style="list-style-type: none">Enter BF.Replace <i>n</i> with a number ranging from 0 through 512 to identify the bar code field. The <i>SR</i> and <i>SC</i> parameters specify the exact location of the bar code field identified by <i>n</i>.The length of the data field need not be specified, since it is fixed at 11 digits, plus any add-on data.The information for the data field is entered dynamically during the Execute Form Mode. (Refer to Execute Form: Dynamic Bar Code Data on page 62.) Do not use the <i>data field</i> parameter to enter data when the <i>BFn</i> parameters are used. However, refer to the <i>data field</i> description for available characters.
DARK	Optional parameter to produce darker looking bar codes. Enter DARK . Refer to Dark Printing on page 52 for more information.
<i>SR</i>	Defines the starting row for the bar code. Enter a value ranging from row 1 to one less than the length of the form. Character row or dot row is specified based on the Scale command (page 95), or use the CP.DP format (page 24).
<i>SC</i>	Defines the starting column of the bar code. Enter a value ranging from column 1 to one less than the width of the form. Character column or dot column is specified based on the Scale command (page 95), or use the CP.DP format (page 24).
(<i>D</i>)	The printable character (delimiter) identifying the start and finish of the data field. Enter any printable character other than a slash (/), the SFCC, or a character used within the data. (It will not print with the data.) Use the same character at both ends of the data field.
<i>data field</i>	Enter the characters for the bar code data, restricted to exactly 11 digits. If the 2- or 5-digit add-on data option is used, include this data at the end of the data field. The first digit is interpreted as the number system character. The remaining 10 digits are the data field characters. The

characters available for the data field are **0** through **9** (hex 30 through 39).

PDF Optional parameter which affects printing of the human readable data field. The data field will print automatically unless the PDF-suppress command is specified in the *FONT* parameter. UPC-A data fields can be printed above or below the bar code symbol. This parameter is not allowed if a null data field is specified. If the PDF command is not entered in the UPC-A command format, the data field automatically prints in OCR-B.

LOC Optional parameter to identify the location of the printable data field. The default value is **B**, locating the human readable data below the bar code. **A** locates the printable data field above bar code. To compensate for printing the 0.1-inch high data, the height of the bar code body is reduced 0.1-inch.

FONT Optional parameter to select the font for the human readable data field. Enter **O** to select OCR-A font; enter **X** to select OCR-B font; enter **N** to select 10 cpi; enter **P** to select 12 cpi; enter **Q** to select 13 cpi; enter **R** to select 15 cpi; enter **T** to select 17 cpi; enter **V** to select 20 cpi. Enter **S** to suppress the PDF entirely.

To select a scalable font with user-defined size, enter **Nh:w** or **F;Nh:w**. The parameters h (height) and w (width) can each range from 1 to 96, and are expansion factors of a 10 cpi character. Nh:w prints in Letter Gothic (font 93779) regardless of the current active font. By default F;Nh:w uses the Letter Gothic as the current font selection. You can change the default by using the *FONT* command.

NOTE: Nh:w and F;Nh:w will not print the PDF wider or taller than the barcode. If the height parameter h causes the PDF to print above the horizontal barcode start row or vertical barcode start column, a barcode font Error will occur. If the width parameter w causes the PDF to exceed the barcode width, the PDF width factor w will automatically reduce to fit within the barcode width without causing an error.

STOP Ends the Bar Code command while the IGP continues in the Create Form Mode. Enter **STOP**. If STOP is not entered, an error message results.

UPC-A Example

Figure 51 illustrates a horizontal and vertical UPC-A bar code generated by the following program:

```
~CREATE;UPCA (Enter Create Form Mode)
BARCODE (Bar Code command)
UPC-A+5;H9;DARK;39;15 (Dark Code UPC-A, 5-digit add-on,
H 0.9, SR 39, SC 15)
*1234567887655555* (Data Field + 5-digit add-on data field)
PDF (Printable Data Field)
STOP (Ends Bar Code command)
BARCODE (New Bar Code command)
UPC-A+5;VSCAN;H12;DARK;39;50 (Vertical Dark UPC-A, 5-digit add-on,
H 1.2, SR 39, SC 50)
*1234567887655555* (Data Field + 5-digit add-on data field)
PDF (Printable Data Field)
STOP (Ends Bar Code command)
END (Terminates Create Form Mode)
~EXECUTE;UPCA;1 (Executes the form, form count of 1)
~NORMAL
```



Figure 51 Sample UPC-A Bar Codes with Add-on Data

UPC-E and UPC-E0

The UPC-E and UPC-E0 bar code structure is shown in Figure 52 and described on the following pages.

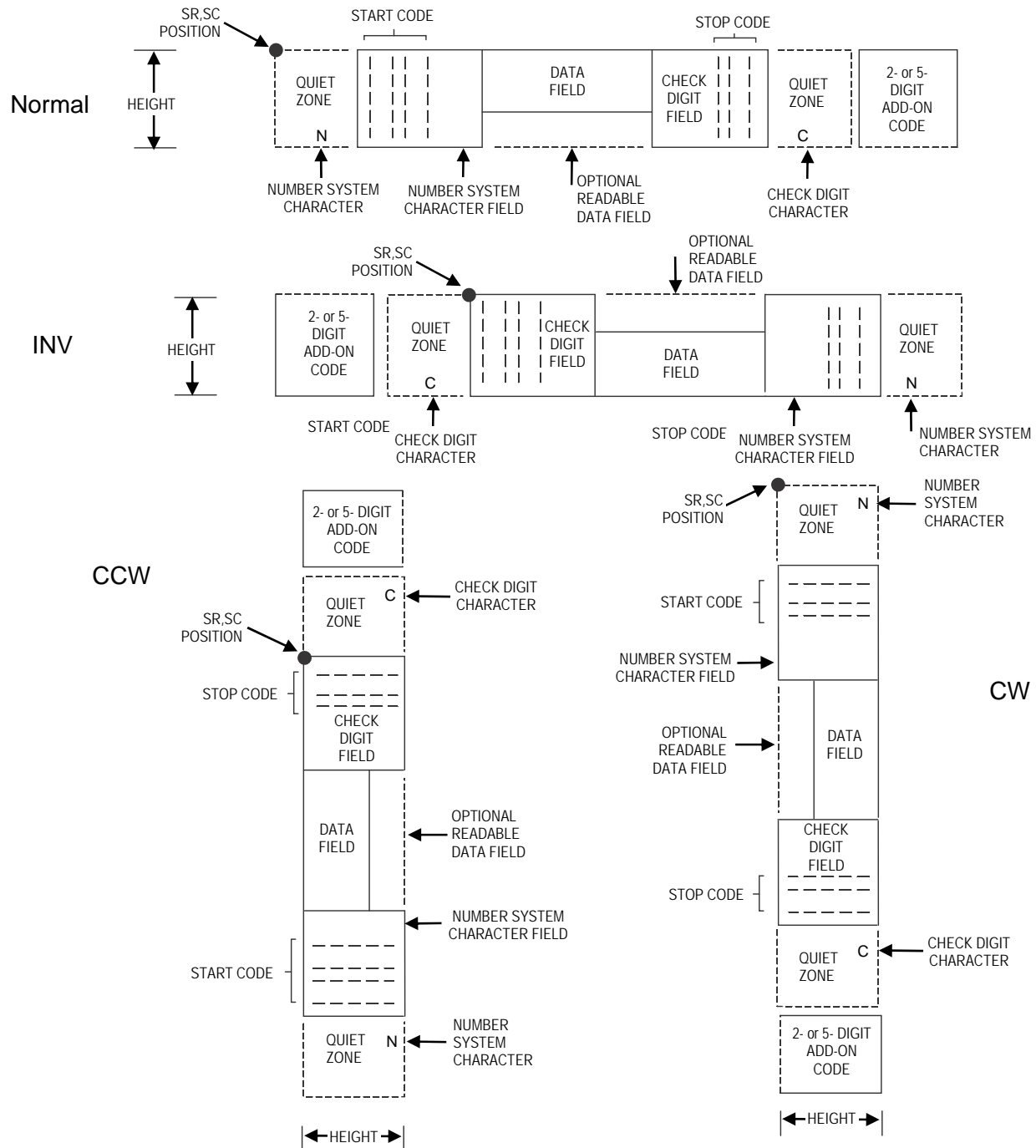

Figure 52 UPC-E and UPC-E0 Structure

Quiet Zone

Quiet zones extend on both ends of the bar code to permit the scan to begin and end in a blank area. The IGP automatically produces an 11-module wide left quiet zone. You must provide sufficient space (minimum of seven modules) on the form for the right quiet zone. The number system character is also printed automatically in the left quiet zone.

Start/Stop Codes

The start/stop codes are special character codes marking those portions of the bar code. These codes are automatically provided.

Number System Character

The number system character field for all UPC-E and UPC-E0 bar codes must be zero.

Data Field

The bar code symbol uses a series of varying width bars and spaces to represent a limited character set (numbers 0-9 and Special Characters Start and Stop). The bars and spaces vary in width from one through four modules. Each character consists of two bars and two spaces that total seven modules.

For UPC-E, eleven digits are expected, which are compressed down to the six encoded symbol characters. For UPC-E0, six compressed digits are expected.

The optional 2- or 5-digit add-on data field is placed at the end of the bar code and typically identifies a periodical issue number or price, respectively.

Readable Data

The human readable data field provides a readable interpretation of the bar code data. It can either be suppressed or printed above or below the bar code symbol.

Check Digit

The modulo-10 check digit is automatically calculated and inserted in the bar code symbol. The check digit verifies accurate scanning. The number system character is included in the check digit algorithm.

UPC-E and UPC-E0 Command Format

```
BARCODE  
type [+n]; [DIR;] [MAG;] [Hn[.m];] [BFn;] [DARK;] SR; SC  
(D)data field(D)  
[PDF [;LOC] [;FONT]]  
STOP
```

BARCODE	The Bar Code command; enter BARCODE .
type	Designates bar code type UPC-E or UPC-E0; enter UPC-E or UPC-E0 .
+n	Optional parameter to provide a 2- or 5-digit add-on code at the end of the bar code. Enter plus (+) and a value of 2 or 5 . The first bar of the add-on code is separated by nine modules from the last bar of the UPC symbol and a left guard pattern.
DIR	Optional parameter that allows for rotating a barcode. Enter CW for clockwise rotation. Enter CCW or VSCAN for counter-clockwise rotation. Enter INV for inverted rotation. If <i>DIR</i> is not entered, the barcode is horizontally oriented.
MAG	Optional parameter to magnify (horizontally expand) the bar code symbol. The magnification default value is X1 . Enter a magnification value from Table 12, page 106 or Table 13, page 107, depending on your printers tip size to increase the magnification. Increasing the

magnification adjusts printed character density. You can also use XR or XRD as defined on page 104. You must specify 8 digits for MAG for variable ratio.

NOTE: There are eight values that comprise the dot ratio: narrow bar, narrow space, 2x narrow bar, 2x narrow space, 3x narrow bar, 3x narrow space, 4x narrow bar, and 4x narrow space. User-defined ratios for this barcode should have these eight values defined in the order specified.

$Hn[.m]$	Optional parameter to adjust the overall height (vertical expansion) of the bar code symbol (including the upper and lower 0.1-inch guard bands and any human readable data). Height adjustments are made in 0.1-inch increments; enter H and a value from 2 through 99 to select height adjustments from 0.2 through 9.9 inches. If any value less than 3 is selected, then the PDF must be suppressed using the PDF Font parameter S . The default value is 1.3 inches. $[.m]$ is an additional number of dots for the bar code height. (Dots are in the current dot scale.)
BFn	Optional parameter for assigning a dynamic bar code data field location on a form. With this parameter, the actual data for the bar code data field is dynamically provided during the Execute Form Mode; the data is not specified during the Create Form Mode. To use this field: <ol style="list-style-type: none">Enter BF.Replace n with a number ranging from 0 through 512 to identify the bar code field. The <i>SR</i> and <i>SC</i> parameters specify the exact location of the bar code field identified by n.The length of the data field need not be specified, since it is fixed at 6 or 11 digits, plus any add-on data.The information for the data field is entered dynamically during the Execute Form Mode. (Refer to Execute Form: Dynamic Bar Code Data on page 62.) Do not use the <i>data field</i> parameter to enter data when the BFn parameters are used. However, refer to the <i>data field</i> description for available characters.
DARK	Optional parameter to produce darker looking bar codes. Enter DARK . Refer to Dark Printing on page 52 for more information.
<i>SR</i>	Defines the starting row for the bar code. Enter a value ranging from row 1 to one less than the length of the form. Character row or dot row is specified based on the Scale command (page 95), or use the CP.DP format (page 24).
<i>SC</i>	Defines the starting column of the bar code. Enter a value ranging from column 1 to one less than the width of the form. Character column or dot column is specified based on the Scale command (page 95), or use the CP.DP format (page 24).
(D)	The printable character (delimiter) identifying the start and finish of the data field. Enter any printable character other than a slash (/), the SFCC, or a character used within the data. The same character must be used at both ends of the data field but it will not print with the data.
<i>data field</i>	The characters available for the data field are 0 through 9 (hex 30 through 39). For UPC-E, eleven digits are expected: Enter the number system character first by entering 0 ; followed by the five-digit Manufacturer Number; ending with the five-digit Item Number. The Manufacturing

Number and Item Number sequences must conform to one of the number pattern sequences shown in Table 38.

The IGP will compress the 11 characters of data down to the six encoded UPC-E symbol characters. Include the 2- or 5-digit add-on data within the quotes at the end of this data field.

For UPC-E0, six digits are expected. These six digits must be a valid compressed UPC-E number. Otherwise, Error 96 will be generated.

PDF	Optional parameter which affects printing of the human readable data field. The data field will print automatically unless the PDF-suppress command is specified in the <i>FONT</i> parameter. UPC-E data fields can be printed above or below the bar code symbol. This parameter is not allowed if a null data field is specified. If the PDF is not entered in the UPC-E command format, the data field automatically prints in OCR-B.
LOC	Optional parameter to identify the location of the printable data field. The default value is B , locating the human readable data below the bar code. A locates the printable data field above bar code. To compensate for printing the 0.1-inch high data, the height of the bar code body is reduced 0.1-inch.
FONT	Optional parameter to select the font for the human readable data field. Enter O to select OCR-A font; enter X to select OCR-B font; enter N to select 10 cpi; enter P to select 12 cpi; enter Q to select 13 cpi; enter R to select 15 cpi; enter T to select 17 cpi; enter V to select 20 cpi. Enter S to suppress the PDF entirely. To select a scalable font with user-defined size, enter Nh:w or F;Nh:w . The parameters h (height) and w (width) can each range from 1 to 96, and are expansion factors of a 10 cpi character. Nh:w prints in Letter Gothic (font 93779) regardless of the current active font. By default F;Nh:w uses the Letter Gothic as the current font selection. You can change the default by using the FONT command.
STOP	Ends the Bar Code command while the IGP continues in the Create Form Mode. Enter STOP . If STOP is not entered, an error message results.

NOTE: Nh:w and F;Nh:w will not print the PDF wider or taller than the barcode. If the height parameter h causes the PDF to print above the horizontal barcode start row or vertical barcode start column, a barcode font Error will occur. If the width parameter w causes the PDF to exceed the barcode width, the PDF width factor w will automatically reduce to fit within the barcode width without causing an error.

Table 38 Eleven-Digit Compression

1. Manufacturer's Number					Product Numbers that can be used 00000-00999		
X	X	0	0	0	(___)	(___)	(___)
X	X	1	0	0	first two digits of manufacturer's number	last three digits of the product number	third digit of the manufacturer's number, use 0 through 2 only
X	X	2	0	0			

2. Manufacturer's Number					Product Numbers that can be used 00000-00999		
X	X	3	0	0	(___)	(___)	(<u>3</u>)
X	X	9	0	0	first three digits of manufacturer's number	last two digits of the product number; use 00-99 only	depends on how many digits appear in the manufacturer's number

3. Manufacturer's Number					Product Numbers that can be used 00000-00999		
X	X	X	X	0	(___)	(___)	(<u>4</u>)
					first four digits of manufacturer's number	last digit of product number, use 0 through 9 only	depends on how many digits appear in the manufacturer's number

4. Manufacturer's Number					Product Numbers that can be used 00000-00999		
X	X	X	X	X	(___)	(___)	
					all five digits of manufacturer's number	last digit of product number, use 5-9 only	

Table 39 Six-Digit Zero Expansion

if the 6 digit number ends with:	then the MFPS number is:	and the Product Number is:
0	the first 2 digits (of the zero)	00 plus the THIRD,
1 Example: 275831	the first two digits plus <u>100</u> 27100	same as above 00583
2 Example: 412022	the first two digits plus <u>200</u> 41200	same as above 00202
3 Example: 876543	the first three digits plus <u>00</u> 87600	000 plus the FOURTH and FIFTH digit 00054
4 Example: 753774	the first four digits plus <u>0</u> 75370	0000 plus the FIFTH digit 00007
5, 6, 7, 8, 9 Examples: 213756 517019	the first five digits of the zero suppressed number 21375 51701	0000 plus the SIXTH digit 00006 00009

UPC-E and UPC-E0 Example

Figure 53 illustrates a horizontal and vertical UPC-E bar code generated by the following program:

```

~CREATE;UPCE                (Enter Create Form Mode)
BARCODE                    (Bar Code command)
UPC-E+2;H9;DARK;34;15    (Dark Code UPC-E, 2-digit add-on,
                           H 0.9, at SR 34, SC 15)
*0927400000522*          (Data Field + the 2-digit add-on)
PDF                        (Printable Data Field)
STOP                       (Ends Bar Code command)
BARCODE                    (New Bar Code command)
UPC-E0+2;VSCAN;H10;DARK;34;50 (Vertical Dark UPC-E0, 2-digit add-on,
                           H 1.0, at SR 34, SC 50)
*92745422*                (Data Field plus the 2-digit add-on)
PDF                        (Printable Data Field)
STOP                       (Ends Bar Code command)
END                        (Terminates Create Form Mode)
~EXECUTE;UPCE0;1          (Executes the form, form count of 1)
~NORMAL

```



Figure 53 Sample UPC-E Bar Codes

UPCSHIP

The structure for the UPCSHP bar code is shown in Figure 54 and described on the following pages.

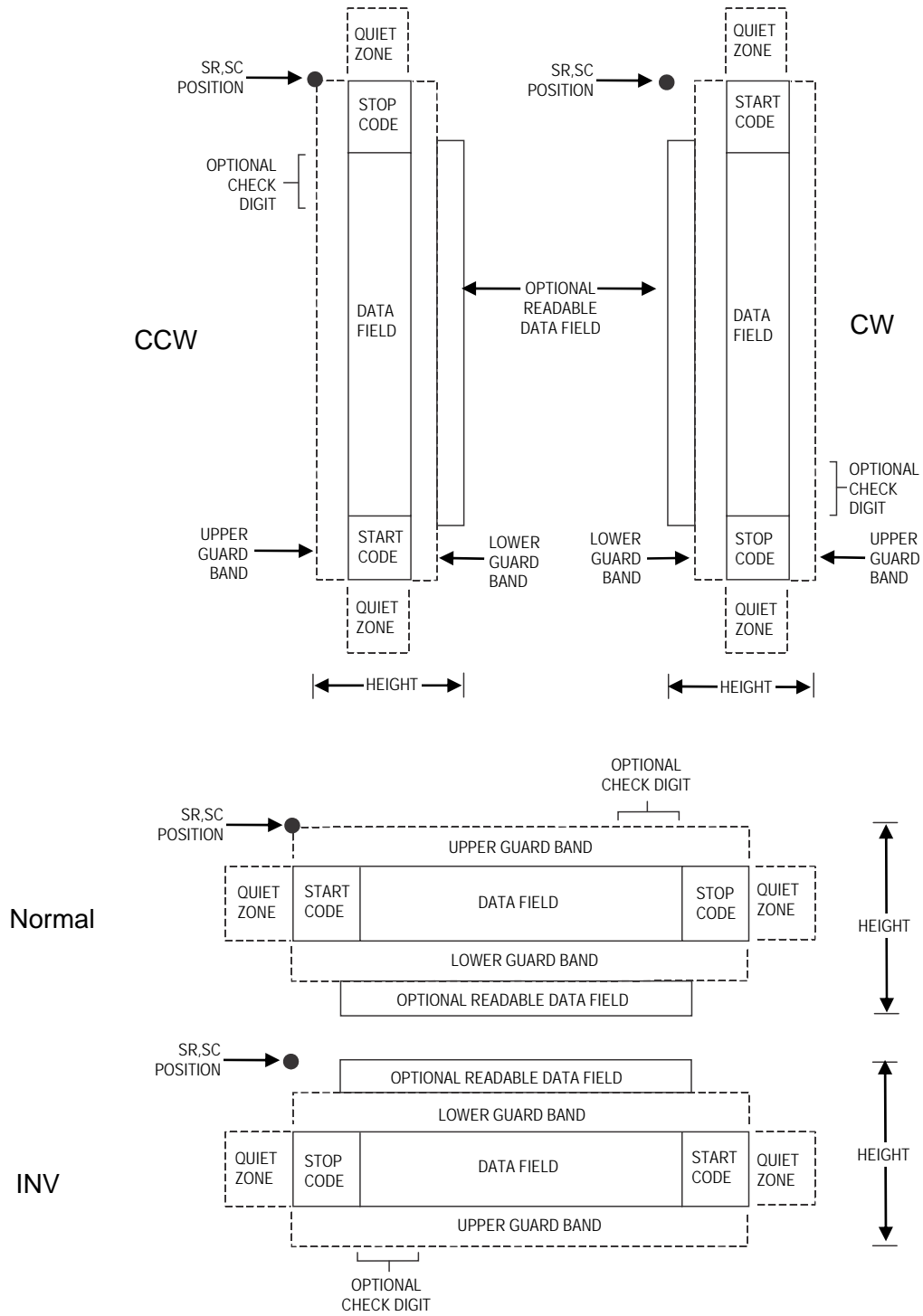

Figure 54 UPCSHP Structure

Quiet Zone

Both ends of the bar code structure have blank quiet zones. The quiet zones must be at least 0.25 inches wide and completely blank to ensure accurate reading of the start/stop codes and to prevent adjacent bar codes from overlapping. You must provide sufficient space on the form for the quiet zones.

Start/Stop Codes

Unique start and stop codes permit bidirectional scanning. Both start and stop codes contain bars and spaces. They are automatically produced.

Data Field

The bar code symbol uses a series of wide and narrow bars and spaces to represent numeric characters. The structure is 2 wide elements (bars or spaces) and 3 narrow elements. The UPCSHIP barcode must contain exactly 13 digits of numeric data.

Readable Data

The optional readable data field provides a readable interpretation of the bar code data. It can be printed above or below the bar code symbol.

Check Digit

The modulo-10 check digit is inserted automatically into the bar code to verify accurate scanning.

UPCSHIP Command Format

```
BARCODE
UPCSHIP; [DIR;] [MAG;] [Hn[.m];] [BFn;] [DARK;] SR; SC
[(D)data field(D)]
[PDF [;LOC] [;FONT]]
STOP
```

BARCODE	The Bar Code command; enter BARCODE .
UPCSHIP	Designates bar code type UPCSHIP; enter UPCSHIP .
DIR	Optional parameter that allows for rotating a barcode. Enter CW for clockwise rotation. Enter CCW or VSCAN for counter-clockwise rotation. Enter INV for inverted rotation. If <i>DIR</i> is not entered, the barcode is horizontally oriented.
MAG	Optional parameter to magnify (horizontally expand) the bar code symbol. The magnification default value is X1 . As required for scanning, enter a magnification value from Table 12, page 106 or Table 13, page 107, depending on your printers tip size to increase the magnification. Increasing the magnification adjusts printed character density. You can also use XR or XRD as defined on page 104.

NOTE: You must specify four digits for MAG for User Defined variable ratio. There are four values that comprise the dot ratio: narrow bar, narrow space, wide bar, and wide space. User-defined ratios for this barcode should have these four values defined in the order specified.

Hn[.m]	Optional parameter to adjust the overall height (vertical expansion) of the bar code symbol (including the upper and lower 0.1-inch guard bands and any human readable data). Height adjustments are made in 0.1-inch increments; enter H and a value from 3 through 99 to select height adjustments from 0.3 through 9.9 inches. The default value is 0.9-inch. [.m] is an additional number of dots for the bar code height. (Dots are in the current dot scale.)
--------	--

NOTE: If 0.3 inches is the selected height, the PDF cannot be included.

<i>BFn</i>	Optional parameter for assigning a dynamic bar code data field location on a form. With this parameter, the actual data for the bar code data field is dynamically provided during the Execute Form Mode; the data is not specified during the Create Form Mode. To use this field, perform the following steps: <ol style="list-style-type: none"> Enter BF. Replace <i>n</i> with a number ranging from 0 through 512 to identify the bar code field. The <i>SR</i> and <i>SC</i> parameters specify the exact location of the bar code field identified by <i>n</i>. The length of the data field need not be specified, since it is fixed at 13 digits, plus any add-on data. The information for the data field is entered dynamically during the Execute Form Mode. (Refer to Execute Form: Dynamic Bar Code Data on page 62.) Do not use the <i>data field</i> parameter to enter data when the <i>BFn</i> parameters are used. However, refer to the <i>data field</i> description for available characters.
DARK	Optional parameter to produce darker looking bar codes. Enter DARK . Refer to Dark Printing on page 52 for more information.
<i>SR</i>	Defines the starting row for the bar code. Enter a value ranging from row 1 to one less than the length of the form. Character row or dot row is specified based on the Scale command (page 95), or use the CP.DP format (page 24).
<i>SC</i>	Defines the starting column of the bar code. Enter a value ranging from column 1 to one less than the width of the form. Character column or dot column is specified based on the Scale command (page 95), or use the CP.DP format (page 24).
<i>(D)</i>	The printable character (delimiter) identifying the start and finish of the data field. Enter any printable character other than a slash (/), the SFCC, or a character used within the data. The same character must be used at both ends of the data field, but it will not print with the data.
<i>data field</i>	The barcode data. The UPCSHIP barcode requires exactly 13 characters of data. The available characters are 0 through 9 (hex 30 through hex 39). The modulo-10 check digit is automatically included in the barcode.
PDF	Optional parameter to enable printing of the human readable data field. Enter PDF to print the data field. If the parameter is not used, the human readable data is not printed.
<i>LOC</i>	Optional parameter to identify the location of the printable data field. The default value is B , locating the human readable data below the bar code. A locates the printable data field above bar code. To compensate for printing the 0.1-inch high data, the height of the bar code body is reduced 0.1-inch.
<i>FONT</i>	Optional parameter to select the font for the human readable data field. Enter O to select OCR-A font; enter X to select OCR-B font; enter N to select 10 cpi; enter P to select 12 cpi; enter Q to select 13 cpi; enter R to select 15 cpi; enter T to select 17 cpi; enter V to select 20 cpi. To select a scalable font with user-defined size, enter Nh:w or F;Nh:w . The parameters h (height) and w (width) can each range from 1 to 96, and are expansion factors of a 10 cpi character. Nh:w prints in Letter Gothic (font 93779) regardless of the current active font. By default

F;Nh:w uses the Letter Gothic as the current font selection. You can change the default by using the FONT command.

NOTE: Nh:w and F;Nh:w will not print the PDF wider or taller than the barcode. If the height parameter h causes the PDF to print above the horizontal barcode start row or vertical barcode start column, a barcode font Error will occur. If the width parameter w causes the PDF to exceed the barcode width, the PDF width factor w will automatically reduce to fit within the barcode width without causing an error.

STOP Ends the Bar Code command while the IGP continues in the Create Form Mode. Enter **STOP**. If STOP is not entered, an error message results.

UPCSHIP Example

```

~CREATE;UPCSHIP          (Enter Create Form Mode)
BARCODE                 (Bar Code command)
UPCSHIP;H12;9;8        (UPCSHIP Bar Code, height 1.2 inches,
                        at SR 9, SC 8)
*0014154401171*       (Data Field)
PDF                    (Print Data Field)
STOP                  (Ends Bar Code command)
BARCODE               (New Bar Code command)
UPCSHIP;VSCAN;3;45    (Vertical UPCSHP Bar Code at SR 3,
                        SC 45)
*1141281029432*       (Data Field)
PDF;A                 (Print Data Field above the bar code)
STOP                  (Ends Bar Code command)
END                   (Terminates Create Form Mode)
~EXECUTE;UPCSHIP;1    (Execute the form, form count of 1)
~NORMAL

```

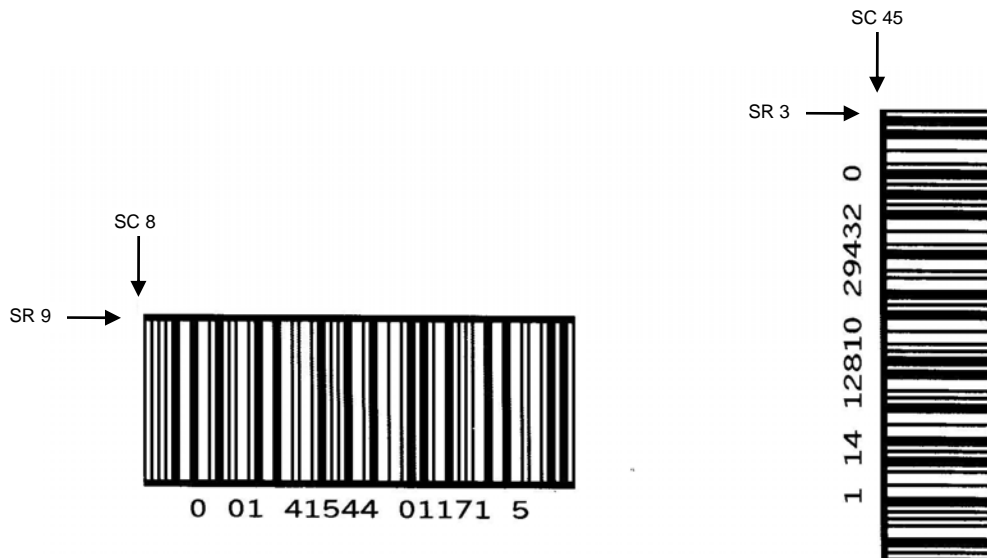

Figure 55 Sample UPCSHP Bar Codes

UPS 11

The UPS 11 structure is shown in Figure 56 and described on the following pages.

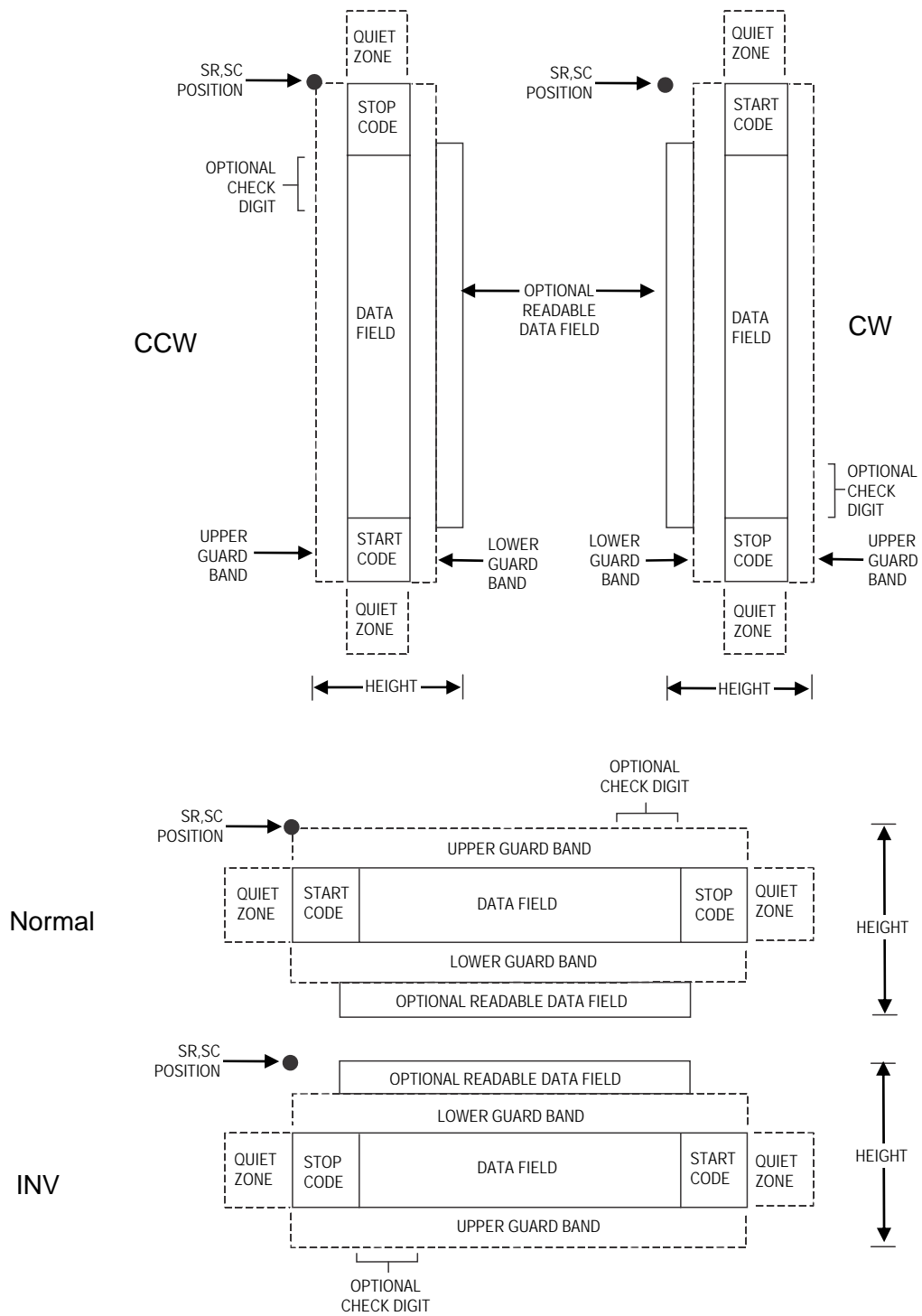

Figure 56 UPS 11 Structure

Quiet Zone

Both ends of the bar code structure require blank quiet zones. The quiet zones must be at least 0.25 inches wide and completely blank to ensure accurate reading of the start/stop codes and to prevent adjacent bar codes from overlapping. Be sure to provide sufficient space on the form for the quiet zones.

Start/Stop Codes

The start/stop codes identify the leading and trailing end of the bar code. Each of the UPS 11 subsets uses a unique start code and a common stop code, both automatically provided by the IGP.

Data Field

UPS 11 is a special case of Code 128 (page 131). This bar code is restricted to 10 data characters. The first character must be 0 through 9 or A through Z. The remaining nine digits must be 0 through 9.

Readable Data

The optional readable data field provides a readable interpretation of the bar code data. It can be printed above or below the bar code symbol.

Check Digit

The modulo-103 check digit is automatically calculated and inserted in the bar code symbol. The check digit verifies accurate scanning. The start code is included in the check digit algorithm.

UPS 11 Command Format

```
BARCODE
UPS11; [DIR;] [MAG;] [Hn[.m];] [BFn;] [DARK;] SR; SC
(D)data field(D)
[PDF [;LOC] [;FONT]] STOP
```

BARCODE	The Bar Code command; enter BARCODE .
UPS11	Designates bar code type UPS 11; enter UPS11 .
DIR	Optional parameter that allows for rotating a barcode. Enter CW for clockwise rotation. Enter CCW or VSCAN for counter-clockwise rotation. Enter INV for inverted rotation. If <i>DIR</i> is not entered, the barcode is horizontally oriented.
MAG	Optional parameter to magnify (horizontally expand) the bar code symbol. The magnification default value is X1 . Increasing the magnification adjusts printed character density as shown in Table 12, page 106 or Table 13, page 107, depending on your printers tip size. You can also use XR or XRD as defined on page 104. You must specify 8 digits for <i>MAG</i> for variable ratio.

NOTE: There are eight values that comprise the dot ratio: narrow bar, narrow space, 2x narrow bar, 2x narrow space, 3x narrow bar, 3x narrow space, 4x narrow bar, and 4x narrow space. User-defined ratios for this barcode should have these eight values defined in the order specified.

Hn[.m]	Optional parameter to adjust the overall height (vertical expansion) of the bar code symbol (including the upper and lower 0.1-inch guard bands and any human readable data). Height adjustments are made in 0.1-inch increments; enter H and a value from 3 through 99 to select height adjustments from 0.3 through 9.9 inches. The default value is 0.9 inch. [.m] is an additional number of dots for the bar code height. (Dots are in the current dot scale.)
--------	---

NOTE: If 0.3 inches is the selected height, the PDF cannot be included.

BF <i>n</i> ;	Optional parameters for assigning a dynamic bar code data field location on a form and for designating the length of the data field. With these parameters, the actual data for the bar code data field is dynamically provided during the Execute Form Mode; the data is not specified during the Create Form Mode. To use this field, perform the following steps. <ol style="list-style-type: none"> Enter BF. Replace <i>n</i> with a number ranging from 0 through 512 to identify the bar code field. The <i>SR</i> and <i>SC</i> parameters specify the exact location of the bar code field identified by <i>n</i>. The length of the data field need not be specified, since it is fixed at 10 digits. The information for the data field is entered dynamically during the Execute Form Mode. (Refer to Execute Form: Dynamic Bar Code Data on page 62.) Do not use the <i>data field</i> parameter to enter data when the <i>BF</i><i>n</i>;<i>L</i> parameters are used. However, refer to the <i>data field</i> description for available characters.
DARK	Optional parameter to produce darker looking bar codes. Enter DARK . Refer to Dark Printing on page 52 for more information.
<i>SR</i>	Defines the starting row for the bar code. Enter a value ranging from row 1 to one less than the length of the form. Character row or dot row is specified based on the Scale command (page 95), or use the CP.DP format (page 24).
<i>SC</i>	Defines the starting column of the bar code. Enter a value ranging from column 1 to one less than the width of the form. Character column or dot column is specified based on the Scale command (page 95), or use the CP.DP format (page 24).
<i>(D)</i>	The printable character (delimiter) identifying the start and finish of the data field. Enter any printable character other than a slash (/), the SFCC, or a character used within the data. The same character must be used at both ends of the data field, but it will not print with the data.
<i>data field</i>	Enter the data for the bar code. This bar code is restricted to 10 data characters. The first character must be 0 through 9 or A through Z . The remaining nine digits must be 0 through 9 .
PDF	Optional parameter to enable printing of the human readable data field. Enter PDF to print the data field. If the parameter is not used, the human readable data will not print. This parameter is not allowed if a null data field was specified.
<i>LOC</i>	Optional parameter to identify the location of the printable data field. The default value is B , locating the human readable data below the bar code. A locates the printable data field above bar code. To compensate for printing the 0.1-inch high data, the height of the bar code body is reduced 0.1 inch.
<i>FONT</i>	Optional parameter to select the font for the human readable data field. Enter O to select OCR-A font; enter X to select OCR-B font; enter N to select 10 cpi; enter P to select 12 cpi; enter Q to select 13 cpi; enter R to select 15 cpi; enter T to select 17 cpi; enter V to select 20 cpi. To select a scalable font with user-defined size, enter Nh:w or F;Nh:w . The parameters h (height) and w (width) can each range from 1 to 96, and are expansion factors of a 10 cpi character. Nh:w prints in Letter

Gothic (font 93779) regardless of the current active font. By default F;Nh:w uses the Letter Gothic as the current font selection. You can change the default by using the FONT command.

NOTE: Nh:w and F;Nh:w will not print the PDF wider or taller than the barcode. If the height parameter h causes the PDF to print above the horizontal barcode start row or vertical barcode start column, a barcode font Error will occur. If the width parameter w causes the PDF to exceed the barcode width, the PDF width factor w will automatically reduce to fit within the barcode width without causing an error.

STOP Ends the Bar Code command while the IGP continues in the Create Form Mode. Enter **STOP**. If STOP is not entered, an error message results.

UPS 11 Example

Figure 57 illustrates a vertical UPS 11 bar code generated by the following program:

```
~CREATE;UPS11  
BARCODE  
UPS11;VSCAN;H9;34;15  
*01234567895*  
PDF  
STOP  
END  
~EXECUTE;UPS11;1  
~NORMAL
```



Figure 57 Sample UPS Bar Code

Incremental Bar Code Fields

With the incremental bar code fields feature, you can update bar code (and alphanumeric) data fields in a numeric or alphabetical manner automatically with just one set of data sent from the host computer. You can print up to 65,535 forms with incremental fields automatically updated.

NOTE: Throughout the discussion of incremental fields, the term “increment” or “incremental” means the field is automatically updated by a specified amount (or increment). You can actually increment the field by a positive amount (added) or a negative amount (subtracted) as specified within the command.

You can use bar code incremental fields with fixed (static) data input as part of the Create Form Mode, or with dynamic data supplied in the Execute Form Mode. New formats and parameters are required in the bar code commands for static and dynamic incremental fields. In addition, the Execute Form command requires a new format and parameters when you use incremental fields with dynamic data. You can increment or decrement incremental fields, repeat at specified intervals before updating, and reset to the starting value after a specified number of increments.

Incrementing Bar Code Data

Incrementing is controlled with the STEPMASK and STARTDATA command parameters as described in Table 40. The parameters are part of the bar code command or part of the Execute command when using the Incremental Bar Code Dynamic Data command.

The STEPMASK parameter performs three functions:

1. It defines the increment amount (step);
2. It defines the number of characters allowed in the data field (STARTDATA); and
3. It provides a “mask” to link or unlink subfields of data for individual incremental activity. The data provided in the STEPMASK field combined with the data in the STARTDATA field determine the +result of these functions.

Table 40 Incremental Bar Code Data

STEPMASK	STARTDATA	Character Type and Function
0-9	A-Z	Alpha characters are incremented by amount in STEPMASK field.
0-9	0-9	Numeric characters are incremented by amount in STEPMASK field.
0-9	Space	Same character type as character in the next right adjacent, linked increment position. Character type is numeric if in the least significant position.
0-9	Not A-Z or 0-9	Error
Not 0-9 or L	Any	Non-incrementing alphanumeric character.
L	Any	Linked, non-incrementing alphanumeric character.

The increment amount is defined by the numeric value of the STEPMASK data. For example, a STEPMASK value of 1 increments the STARTDATA by 1; a STEPMASK value of 2 increments the STARTDATA by 2.

The maximum number of characters allowed in the STARTDATA is defined by the number of characters in the STEPMASK field and depends on the specific type of bar code; the STARTDATA field cannot contain more characters than used in the STEPMASK field and can only contain the number and type of characters allowed by the bar code.

Linked and unlinked masking of subfields within the STARTDATA is defined by using the L value in the STEPMASK field. L indicates linked but non-incrementing data in the corresponding position of the STARTDATA field. Any alphanumeric character other than L in the STEPMASK field indicates a non-incrementing, non-linked STARTDATA subfield.

The following examples illustrate incrementing of bar code data fields. All cases in the examples use a repeat count parameter value of 1 and a reset count parameter value of 0. Incremental bar code data is generated identically to incremental alphanumeric data except the IGP does not add leading spaces to bar code data.

NOTE: In the following bar code examples, the *value* of the data is shown automatically incrementing. In practical applications, the bar code itself would print corresponding to the incremented data as shown in the Auto Increment Fields Example in Chapter 2.

	Value	Description
STARTDATA:	ABC123	Linked subfields: ABC and 123 RPT = 1 RST = 0
STEPMASK:	000001	
Printed Results:	ABC123	
	ABC124	
	
	
	
	ABC999	
	ABD000	
	
	
	
	ZZZ999	
	AAA000	

	Value	Description
STARTDATA:	1ABC123	Two separate but linked numeric subfields: 1 and 123, while fixed data ABC is non-incrementing RPT = 1 RST = 0
STEPMASK:	0LLL001	
Printed Results:	1ABC123	
	1ABC124	
	. . .	
	. . .	
	. . .	
	1ABC999	
	2ABC000	

	Value	Description
STARTDATA:	ABC123	Two separate unlinked subfields: ABC and 3, while fixed data 1 and 2 is non-incrementing
STEPMASK:	001XX1	
Printed Results:	ABC123	RPT = 1
	ABD124	RST = 0
	. .	
	. .	
	. .	
	ABI129	
	ABJ120	

Incremental Bar Code Fixed Data Fields

The Incremental Bar Code Fixed Data Fields command is a variation of the standard IGP bar code commands. Use this command with the appropriate parameters from the standard bar code command when automatic incrementing of fixed bar code data fields is required. The Incremental Bar Code Fixed Data Fields command format is shown and defined below. (Incremental command parameters are shown in **boldface** type; standard bar code command parameters and optional non-incremental parameters are shown in *italics*.)

BARCODE

type; [DIR;] [MAG;] [Hn;m] l; [DARK;] SR; SC

[idir] STEPMASK; [RPTn;] [RSTn;] (D)STARTDATA(D)

[PDF [;LOC] [;FONT]]

STOP

I	Identifies this bar code command as an Incremental Bar Code command; enter I .
<i>idir</i>	The optional increment direction parameter to specify an increment (add) or decrement (subtract) to the data. Enter a plus sign (+) or leave the field blank to increment (the default). Enter a minus sign (-) to decrement.
STEPMASK	Defines the increment amount (step), number of character positions in the data field, and provides a mask to control the increment function on specific parts of the data. Refer to Incrementing Bar Code Data on page 253 for complete information on STEPMASK parameter values.
RPTn	The optional incremental repeat count parameter to specify the number of times a particular field value will repeat before it is incremented. A repeated field value is useful when printing multiple rows/columns of identical labels before increasing to the next value. To use the repeat count parameter, enter RPT and replace <i>n</i> with a numeric value ranging from 1 through 65535 to specify the repeat count. The default repeat count parameter is 1, which will increment the field value each time it is printed.
RSTn	The optional incremental reset count parameter to specify the number of times an incremented field is printed (on one or more forms) before it is reset to the starting value. A reset count is useful when printing a hierarchy of fields where a low-level field generates a sequence of numbers, is reset, and the next higher field level is incremented (such as in a unit/box/carton application). To use the reset count parameter, enter

RST and replace *n* with a number ranging from **1** through **65535** to specify the reset count. The default reset count value is 0.

STARTDATA Defines the starting value of the incrementing field. The maximum amount of **STARTDATA** characters must be less than or equal to the number of characters in the **STEPMASK** field. Characters allowed for incrementing fields is based on the type of bar code; refer to the individual bar code descriptions for information on valid type and quantity of data characters. The **STARTDATA** must be enclosed within standard printable character delimiters just as a standard bar code data field is enclosed within delimiters.

```
~CREATE;TEST;288                (Enters Create Form mode)
VDUP;3;6                          (Bar code command)
BARCODE                            (Bar code command)
C3/9;H7;I;6;5                    (Printable data field)
-00001;*12345*                    (Ends bar code command) VDUP;OFF
PDF                                (Terminates Create Form mode)
STOP                               (Prints form)
END                                (Prints form)
~EXECUTE;TEST                      (Prints form)
~NORMAL
```



12345



12344



12343

Incremental Bar Code Dynamic Data Fields

The Incremental Bar Code Dynamic Data Field command specifies the location and size of the incremental dynamic data field during the Create Form Mode. **STEPMASK** and **STARTDATA** parameters are supplied in the Execute command during the Execute Form Mode. As with standard dynamic data fields, incremental dynamic data fields allow you to change the starting data without changing the form definition program. Additionally, you can also change the increment parameters with each new job without changing the form definition program.

The Incremental Bar Code Dynamic Data Fields command is a variation of the standard IGP bar code commands. Use this command with the appropriate parameters from the standard bar code command when automatic incrementing of dynamic bar code data fields is required. The Incremental Bar Code Dynamic Data Fields command format is shown and defined below. (Incremental command parameters

are shown in **boldface** type; standard bar code command parameters and optional non-incremental parameters are shown in *italics*.)

BARCODE

*type; [DIR;] [MAG;] [Hn;m] **IBFn;L** [DARK;] SR; SC*

[PDF [;LOC] [;FONT]]

STOP

IBFn;L

Identifies this bar code command as an Incremental Bar Code Dynamic Data Field command. The command parameter string identifies the incremental dynamic data field location on the form and defines the length of the bar code data. If these parameters are used, do not enter the STEPMASK and STARTDATA parameters in the Create Form Mode; enter them dynamically during the Execute Form Mode. To use the incremental dynamic data field:

- a. Enter **IBF** to specify an incremental bar code dynamic data field.
- b. Replace *n* with a number ranging from **0 through 512** to identify the bar code string location on the form. The standard bar code *SR* and *SC* command parameters specify the exact location of the field identified by *n*.
- c. Replace *L* with a number equal to the number of characters in the dynamic bar code string. The number of characters and type of characters depends on the type of bar code used. Refer to the individual bar code descriptions for information on type and quantity of data allowed for the specific bar code type.
- d. Dynamically enter the STEPMASK and STARTDATA parameters in the Execute Form Mode. The length of the data must be less than or equal to the value assigned to the length (*L*) parameter. Refer to Execute Form: Incremental Dynamic Data on page 63 for more information.

Duplicating Incremental Bar Code Fields

Fixed and dynamic incremental bar code data fields are duplicated horizontally and vertically in the same way that incremental alphanumeric fixed and dynamic data fields are duplicated. Refer to Chapter 2 for more information on duplicating incremental data.

```
~CREATE;TEST;288                (Enters Create Form mode)
VDUP;3;6
BARCODE                          (Bar code command)
C3/9;H7;IBF1;6;6;5
PDF
STOP                              (Ends bar code command) VDUP;OFF
END                              (Terminates Create Form mode)
~EXECUTE;TEST                    (Prints form)
~IBF1;+000001;*123459*
~NORMAL
```



123459



123460



123461

4 *Form Examples And Exercises*

Form Examples

NOTE: To aid in maintenance of a form or logo, comments can be added to many command lines within the CREATE or CREATE LOGO mode. Comments must be preceded by a slash (/). Do NOT use the / comment feature on lines containing an SFCC (e.g., commands used within NORMAL or EXECUTE mode). Throughout this manual, comments are provided in parenthesis beside most command lines for better understanding of IGP/PGL operation but should not be included in your IGP/PGL files. Below are some examples of when comments are allowed and NOT allowed.

CREATE Mode (Allowed – no SFCC required)

```
BOX  
1;6;15;11;37           /Create Box STOP  
FONT;BOLD ON           /Turn on Bolding  
BARCODE  
C128A;X1;H10;BF1;10;11;2   /C128A barcode  
STOP
```

NORMAL Mode (Not Allowed – SFCC required)

```
~NORMAL  
~DENSITY;10  
~PAPER;PORTRAIT  
~CREATE;XYZ;792
```

EXECUTE Mode (Not Allowed – SFCC required)

```
~EXECUTE;XYZ  
~AF1;*Data For Alpha*
```

NOTE: Using a different type of printer or a different configuration could affect the appearance of your printed samples compared to those shown in this manual. Additionally, depending on the paper, top-of-form setting and initial print position, the positioning of your printed samples on the page may vary compared to the examples shown here; these samples have been positioned on the page to correspond with the related text.

The example on the following page demonstrates how to use Create commands in the Create Form mode using the CP.DP format. The printed output for this program is shown in Figure 58 on page 261. (The Hand logo used in this example was previously defined and stored and, thus, is not shown in the form program.) The box surrounding the form represents the paper size.

Example: Create Commands

~CREATE;BASICFRM

BOX
/LT;SR;SC;ER;EC
1;1;1;25;25
STOP

ALPHA
/[R;][E;][Cn;][AFn;L;][DIR;][UC;][DARK;][POINT;][HSn;]SR;SC;VE;
/HE;(D)ASCIITEXT(D) 3;3;0;0;*STATIC ALPHA DATA*
AF1;18;4;3;0;0
/DIR;SR;SC;VE;HE
CW;8;4;1;1;*PRINTRONIX*
R;15;5;2;2;*IGP*
STOP

CORNER
/LT;SR;SC;ER;EC;VL;HL
1;18;2;23;7;2;2
STOP

HDUP;5;1
VERT
/LT;C;SR;ER
1;17;18;22
STOP
HDUP;OFF

VDUP;5;1
HORZ
/LT;R;SC;EC
1;18;17;21.1
STOP
VDUP;OFF

LOGO 10;13;HAND
/(PREVIOUSLY DEFINED AND STORED)
STOP

END

~EXECUTE;BASICFRM
~AF1;*DYNAMIC ALPHA DATA*

OVERLAY DATA

~NORMAL

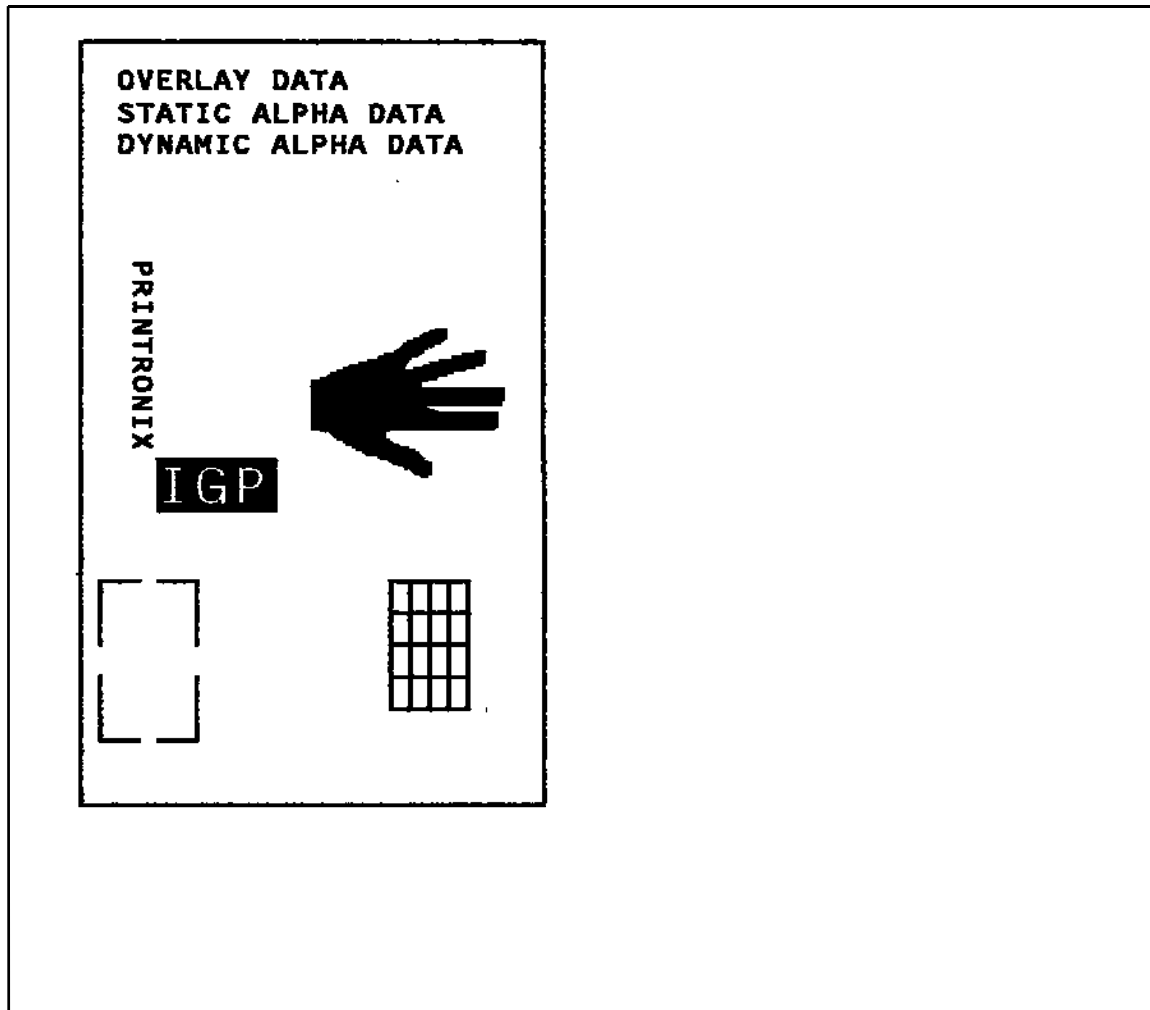

Figure 58 Basic Create Form Example

Example: Using The Setup Command

The following example demonstrates how the margins, landscape orientation, 8LPI and double wide font are automatically SETUP at power-up.

```
~SETUP
TOP/BOTTOM MARGIN;1
LEFT MARGIN;10
END
~PAPER;ROTATE 90
~LPI;8
~EXPAND;1;2
~SETUPEND
```

Example: Dynamic Data

The process of executing dynamic alphanumeric and bar code data fields is explained in the following exercises. Each stage includes printing the program; however, the total program may be entered as one unit. Each stage offers the option of choosing features applicable to specific needs.

Basic Design

The SAMPLE program below, shown in Figure 59, is a basic design in CP.DP format and defined by standard Create Form mode command sequences. The label is duplicated twice horizontally on an approximate form size of 8 1/2 x 5 1/2 inches (390 dots), with three bar code locations specified per label. The result is two "forms": two labels per form, four labels printed on one 8 1/2 x 11 inch "page". On the next few pages, you will add bar code data, dynamic alphanumeric data, and dynamic bar code data. Then you will execute and print the complete form (Figure 60).

When entering command lines, remember to correctly terminate each line with a line feed or carriage return with line feed. Use your system commands to open a file for the label program. When you have finished, exit the file (if necessary for your system) and print.

```
~CREATE;SAMPLE;390      (Create Form; form length is 390 dots)
HDUP;2;37              (2 horizontal dupes, 37 columns apart)
BOX                    (Box command)
2;3.5;9;30;35
STOP                  (Stop the Box command)
HORZ                  (Horizontal Line command)
1;14.5;9;35
1;19.5;9;35
1;24.5;9;35
STOP                  (Stop the Horizontal Line command)
CORNER                (Begin Corner command)
2;4;11;9;33;1.2;2
2;9.6;11;13.6;33;1.2;2
STOP                  (Stop the Corner command)
ALPHA                 (Begin Alphanumeric command)
4.8;12;0;0;*FROM:*   (This is fixed text on the form)
6.3;12;2;2;*ACME INC.*
C15;7.3;16;0;0;*15345 Barranca Parkway*
C15;8.1;16;0;0;*IRVINE , CA 92618*
10;12;0;0;*TO*
14.8;11;0;0;*S.O.*
19.8;11;0;0;*S/N:*
24.8;11;0;0;*P/N:*
STOP                  (Stop the Alphanumerics command)
HDUP;OFF              (Stop the horizontal duplication)
END                   (End the Create Form mode)
~EXECUTE;SAMPLE;1     (Execute form)

~NORMAL
~EXECUTE;SAMPLE;1     (Execute again to print second form)

~NORMAL
~FF
```

<p>FROM: ACME INC.</p> <p>15345 Barranca Parkway Irvine, CA 92618</p> <p>TO</p>
S.O.
S/N:
P/N:

<p>FROM: ACME INC.</p> <p>15345 Barranca Parkway Irvine, CA 92618</p> <p>TO</p>
S.O.
S/N:
P/N:

<p>FROM: ACME INC.</p> <p>15345 Barranca Parkway Irvine, CA 92618</p> <p>TO</p>
S.O.
S/N:
P/N:

<p>FROM: ACME INC.</p> <p>15345 Barranca Parkway Irvine, CA 92618</p> <p>TO</p>
S.O.
S/N:
P/N:

Figure 59 Sample Form

Bar Code Fields

Identify the location of the data fields for each of the six bar codes (one location at each S.O., S/N, and P/N field on the form). The type of bar code and the human readable data information is also specified within the bar code commands. (Refer to Chapter 3 for detailed bar code information.)

Each bar code must be designated separately. The bar code commands are part of the Create Form mode; therefore, they must be entered in the Create Form mode before the END command. However, because each dynamic field is assigned a unique number, the commands should not be duplicated. Reopen the file and input the following commands before the END command line but after the HDUP;OFF command.

NOTE: The IGP/PGL will horizontally or vertically duplicate dynamic bar code or alphanumeric data fields if required. This will also duplicate the *n* parameter identifying the dynamic data fields. If unique data fields are required, do not duplicate the commands.

BARCODE	(First bar code command)
C3/9;H7;BF1;8;DARK;15.1;10.4	(Upper left S.O. field, assigned #1)
C3/9;H7;BF1;8;DARK;15.1;10.4	
PDF;O	(Print the data field in OCR-A font)
STOP	(Stop the first bar code command)
BARCODE	(New bar code command)
C3/9;H7;BF2;8;DARK;20;10.4	(Upper left S/N field, assigned #2)
PDF;O	
STOP	
BARCODE	
C3/9;H7;BF3;8;DARK;25.5;10.4	(Upper left P/N field, assigned #3)
PDF;O	
STOP	
BARCODE	
C3/9;H7;BF4;8;DARK;15.1;47.4	(Upper right S.O. field, assigned #4)
PDF;O	
STOP	
BARCODE	
C3/9;H7;BF5;8;DARK;20;47.4	(Upper right S/N field, assigned #5)
PDF;O	
STOP	
BARCODE	
C3/9;H7;BF6;8;DARK;25.5;47.4	(Upper right P/N field, assigned #6)
PDF;O	
STOP	(Stop the bar code command)

Dynamic Alphanumeric Fields

Identify the location of the dynamic alphanumeric fields using the alphanumerics command. Input the following alphanumeric command lines after the HDUP;OFF command and before the Create Form mode END line. A separate alphanumerics command sequence is used in order to assign unique numbers to each dynamic data field. (If unique identifying numbers were not required, these alphanumeric commands would be added to the existing alphanumeric commands being duplicated to produce the fixed form alphanumeric data.)

NOTE: Before the following dynamic data commands can be entered, delete the form count parameter from the existing Execute command line (the ;1 at the end of the Execute command line shown on the program on page 262). The Form Count parameter cannot be used when data is supplied dynamically. The Execute command line should now read ~EXECUTE;SAMPLE and must be correctly terminated. This is the Execute command for the first page of dynamic data.

ALPHA	(Begin alpha command for dynamic data)
AF1;20;10.8;12;0;0	(AF1 - 1st line of upper left TO area)
AF2;20;11.8;12;0;0	(AF2 - 2nd line of upper left TO area)
AF3;20;12.8;12;0;0	(AF3 - 3rd line of upper left TO area)
AF4;20;10.8;49;0;0	(AF4 - 1st line of lower left TO area)
AF5;20;11.8;49;0;0	(AF5 - 2nd line of lower left TO area)
AF6;20;12.8;49;0;0	(AF6 - 3rd line of lower left TO area)
STOP	(Stop the alphanumeric command)

Dynamic Alphanumeric and Bar Code Data



Enter the following dynamic data following the Execute command. These dynamic data commands will supply the variable data to the bar code and alphanumeric fields previously identified in the Create Form mode. After entering the data, exit the file (if necessary with your system) and print. The completed form is shown in Figure 60.



```

~EXECUTE;SAMPLE
~AF1;*B AND C CO.*           (Upper left label addressee)
~AF2;*P.O. BOX 212*
~AF3;*LOS ANGELES, CA 90051*
~AF4;*M. H. INC*           (Upper right label addressee)
~AF5;*101 BEACH RD*
~AF6;*MALIBU, CA 97772*
~BF1;*S05995*             (Upper left label S.O.)
~BF2;*011233*             (Upper left label S/N)
~BF3;*190204*             (Upper left label P/N)
~BF4;*S05996*             (Upper right label S.O.)
~BF5;*000535*             (Upper right label S/N)
~BF6;*104523*             (Upper right label P/N)
~FF                        (Completes 1st form-upper labels)
~AF1;*ABC CORPORATION* (Lower left label addressee)
~AF2;*1234 ANYWHERE ST*
~AF3;*YOUR TOWN, MA 03498*
~AF4;*XYZ COMPUTERS*      (Lower right label addressee)
~AF5;*845 N. ALLEN ST*
~AF6;*WEST BEND, OR 97601*
~BF1;*S05997*             (Lower left label S.O.)
~BF2;*456789*             (Lower left label S/N)
~BF3;*102245*             (Lower left label P/N)
~BF4;*S05999*             (Lower right label S.O.)
~BF5;*567890*             (Lower right label S/N)
~BF6;*103764*             (Lower right label P/N)
~NORMAL                    (Completes 2nd form-lower labels)

```

Multiple page documents must be separated by a form feed. (The "page" of data includes the Execute command, the dynamic data commands, and the Normal command.) Using the SFON command (described on page 98), a ~FF (form feed) command will allow as many forms as required to print with the appropriate new data supplied dynamically. When the SFOFF command is used, send a hex 0C instead of ~FF to print multiple pages with new dynamic data.

<p>FROM: ACME INC. 15345 Barranca Parkway Irvine, CA 92618</p> <p>TO B AND C CO P.O. BOX 212 LOS ANGELES, CA 90051</p>
<p>S.O.</p>  <p>SO5995</p>
<p>S/N:</p>  <p>011233</p>
<p>P/N:</p>  <p>190204</p>

<p>FROM: ACME INC. 15345 Barranca Parkway Irvine, CA 92618</p> <p>TO M. H. INC 101 BEACH RD MALIBU, CA 97772</p>
<p>S.O.</p>  <p>SO5996</p>
<p>S/N:</p>  <p>000535</p>
<p>P/N:</p>  <p>104523</p>

<p>FROM: ACME INC. 15345 Barranca Parkway Irvine, CA 92618</p> <p>TO ABC CORPORATION 1234 ANYWHERE ST YOUR TOWN, MA 03498</p>
<p>S.O.</p>  <p>SO5997</p>
<p>S/N:</p>  <p>456789</p>
<p>P/N:</p>  <p>102245</p>



<p>FROM: ACME INC. 15345 Barranca Parkway Irvine, CA 92618</p> <p>TO XYZ COMPUTERS 845 N. ALLEN ST WEST BEND, OR 87601</p>
<p>S.O.</p>  <p>SO5999</p>
<p>S/N:</p>  <p>567890</p>
<p>P/N:</p>  <p>103764</p>

Figure 60 Dynamic Data Example

Example: Auto Increment Fields

The following program, designed in accordance with current specifications for AIAG-B-3 shipping label standards, creates four automatically incrementing/decrementing AIAG labels with alphanumeric and bar code data. The printed output of this program is shown on page 269.

```
~CREATE;AIAG
BOX
1;31.2;1;55.2;66.5
STOP
HORZ
1;38.5;1;66.5
1;44.9;1;40
1;49.10;1;40
STOP
VERT
1;26;38.5;44.9
1;40;44.9;55.2
STOP
ALPHA
C15;31.8;2;0;0;*PART NO*
C15;32.6;2;0;0;*(P)*
I;34.3;9;4;4;00000000001;*A0000000001*
C15;38.9;2;0;0;*QUANTITY*
C15;39.6;2;0;0;*(Q)*
40.5;8;4;4;*100*
C15;41.9;28;0;0;*SPECIAL*
C15;42.6;28;0;0;*(C)*
I;43.9;34;4;4;-00001;*A20UG*
C15;45;2;0;0;*SUPPLIER*
C15;45.10;2;0;0;*(V)*
45.7;7;2;2;* 040898755*
C15;50.4;2;0;0;*SERIAL*
C15;51.2;2;0;0;*(S)*
50.8;7;2;2;* 0002110*
C15;54.5;4;0;0;*ACME MOTOR, INC IRVINE CA 92713 (714) 863-1900*
STOP
BARCODE
C3/9;H7;I;DARK;34.7;5.5
X000000002;*A000000002*
STOP
BARCODE
C3/9;H7;DARK;40.9;5.5
*Q100*
STOP
BARCODE
C3/9;H7;I;DARK;38.1;33
-X00002;*CA2OUF*
STOP
BARCODE
C3/9;H7;DARK;45.11;5.5
*V040898755*
STOP
BARCODE
C3/9;H7;DARK;50.9;5.5
*S0002110*
STOP
```

BOX
1;1.2;1;25.2;66.5
STOP
HORZ
1;8.4;1;66.5
1;14.9;1;40
1;19.6;1;40
STOP
VERT
1;26;8.4;14.9
1;40;14.9;25.2
STOP
ALPHA
C15;1.8;2;0;0;*PART NO*
C15;2.6;2;0;0;*(P)*
I;4.3;9;4;4;00000000002;*A0000000001*
C15;8.9;2;0;0;*QUANTITY*
C15;9.6;2;0;0;*(Q)*
10.5;8;4;4;*100*
C15;11.9;28;0;0;*SPECIAL*
C15;12.6;28;0;0;*(C)*
I;13.9;34;4;4;-00002;*A20UG*
C15;15;2;0;0;*SUPPLIER*
C15;15.10;2;0;0;*(V)*
15.6;7;2;2;* 040898755*
C15;20;2;0;0;*SERIAL*
C15;21;2;0;0;*(S)*
20.5;7;2;2;* 0002110*
C15;24.5;4;0;0;*ACME MOTOR,INC. IRVINE CA 92713 (714) 863-1900*
STOP
BARCODE
C3/9;H7;I;DARK;4.7;5.5
X000000002;*A000000001*
STOP
BARCODE
C3/9;H7;DARK;10.9;5.5
Q100
STOP
BARCODE
C3/9;H7;I;DARK;8.1;33
-X00002;*CA20UG*
STOP
BARCODE
C3/9;H7;DARK;15.7;5.5
V040898755
STOP
BARCODE
C3/9;H7;DARK;20.8;5.5
S0002110
STOP
END
~EXECUTE;AIAG;2

~NORMAL

PART NO. (P)		A0000000001	
QUANTITY (Q)		100	SPECIAL (S) A20UG
SUPPLIER (U)		040898755	
SERIAL (X)		0002110	

PART NO. (P)		A0000000002	
QUANTITY (Q)		100	SPECIAL (S) A20UF
SUPPLIER (U)		040898755	
SERIAL (X)		0002110	

PART NO. (P)		A0000000003	
QUANTITY (Q)		100	SPECIAL (S) A20UE
SUPPLIER (U)		040898755	
SERIAL (X)		0002110	

PART NO. (P)		A0000000004	
QUANTITY (Q)		100	SPECIAL (S) A20UD
SUPPLIER (U)		040898755	
SERIAL (X)		0002110	

Figure 61 Auto Increment Fields Example

Form Exercise

In the following example, you will create and execute a form. Using character scaling (discussed in detail on page 95) on a 60 x 72 dot per inch (dpi) grid, your form will include the following:

- a box
- a set of corners
- vertical lines
- alphanumeric data
- horizontal lines
- a bar code

This exercise will help you become familiar with the IGP/PGL by taking you through 14 steps to build a complete form. Detailed command descriptions for producing forms, bar codes, and logos are described in the Commands chapter.

All the data and commands for the form are entered into a file in the host computer. The filename used in this exercise is PRACTC.FRM, and the form name used is PRACTICE. If another form named PRACTICE already exists, it will be deleted by this exercise.

Begin each step by reading the explanation. The information you input is listed under the word **Enter**. The parameters of each command have a specific order for data entry; input the data exactly as shown, but always use the actual SFCC required by your system where the ~ is shown. The general command format is listed under the word **Format** next to each example. The SFCC is represented by (cc) in the general format.

Use the standard commands on your system to open, close, or print the file with the form data where your system format is required.

NOTE: Do not forget to terminate each command line with a line feed (or carriage return with line feed), or a paper motion command. Enter all commands in uppercase. Make sure the printer power is on and the printer is READY, ON-LINE.

Creating A Box And Corners

1. On your host computer, open/create a file for your practice form. For example:

Enter	Format
PRACTC.FRM	(system format)

2. Enter the Create Form mode, and specify a form name. This is the first input for every new form. Use the Create command and PRACTICE as the form name.

Enter	Format
~CREATE;PRACTICE	(cc)CREATE[/];formname[:FL][:DISK]

3. The IGP/PGL is now ready for Create Form mode commands. Design a box with a line thickness (*LT*) of 2 dots, a top left corner at starting row (*SR*) 35, starting column (*SC*) 16, and a bottom right corner at ending row (*ER*) 53, ending column (*EC*) 61. The STOP command must be entered to inform the IGP/PGL that the Box command is complete.

Enter	Format
BOX	BOX
2;35;16;53;61	<i>LT;SR;SC;ER;EC</i>
STOP	STOP

- Use the Corner command to set the box off with corners having a line thickness (*LT*) of 3 dots, a top left corner at row (*SR*) 30, column (*SC*) 13, a bottom right corner at row (*ER*) 57, column (*EC*) 64, a vertical length (*VL*) 5 character spaces long, and a horizontal length (*HL*) 7 character spaces long. The STOP command must be entered to stop the Corner command and END must be entered to terminate the Create Form mode to prepare for printing.

Enter	Format
CORNER	CORNER
3;30;13;57;64;5;7	<i>LT;SR;SC;ER;EC;VL;HL</i>
STOP	STOP
END	END

- Now use the Execute command and form name to prepare for printing. Enter a blank line using a terminator and then the Normal command to instruct the IGP/PGL to return to the Normal mode after executing the form.

Enter	Format
~EXECUTE;PRACTICE [;PAGE <i>n</i>];[<i>FC</i>]	(cc)EXECUTE; <i>formname</i>
~NORMAL	(cc)NORMAL

- To print the form, exit the file (if necessary for your system) and use the system print command to print the file. For example, after exiting the file and your system prompt returns:

Enter	Format
.PRINT PRACTC.FRM	(System Format)

The form should look like the one shown in Figure 62. When it was printed, the form program was stored in the IGP/PGL memory. If errors are detected in the program, error messages are printed and only the error-free portions of the program are stored in the IGP/PGL memory. (Refer to Solving Program Errors on page 289.)

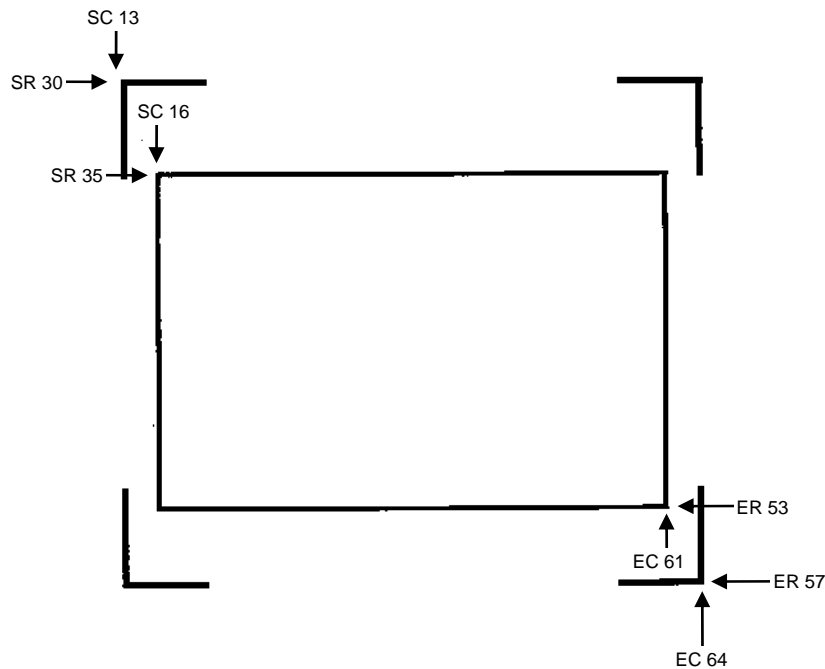

Figure 62 Box and Corner Example

Adding Horizontal And Vertical Lines

7. Now return to the file. When the file reopens, the existing program (the contents of the file) is displayed. Use your system commands to reopen the file. For example:

Enter	Format
.PRACTC.FRM	(System Format)

8. All Create Form mode commands must be entered into the program before the End command line. Add three horizontal lines, each with a thickness (*LT*) of 1, at rows (*R*) 40, 45, and 49 and each ranging from column (*SC*) 16 to column (*EC*) 61.

Enter	Format
HORZ	HORZ
1;40;16;61	<i>LT;R;SC;EC</i>
1;45;16;61	
1;49;16;61	
STOP	STOP

9. Add two vertical lines, each with a thickness (*LT*) of 1, both in column (*C*) 49, one ranging from row (*SR*) 40 to row (*ER*) 45 and the other ranging from row (*SR*) 49 to row (*ER*) 53.

Enter	Format
VERT	VERT
1;49;40;45	<i>LT;C;SR;ER</i>
1;49;49;53	
STOP	STOP

The last two commands have added to the form definition. PRACTICE now looks like Figure 63.

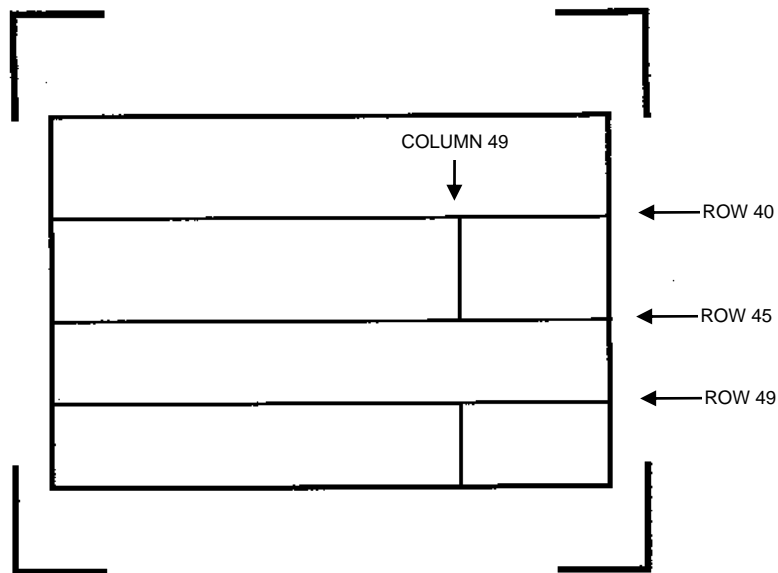

Figure 63 Box/Corner Example with Horizontal and Vertical Lines

Adding Fixed Alphanumeric Text

10. Use the Create Form mode Alpha command to add some fixed alphanumeric text to the form. Specify some compressed print (*Cn*), the starting row (*SR*) and starting column (*SC*) for each alphanumeric string, any vertically (*VE*) or horizontally (*HE*) expanded strings, and the alphanumeric string itself which must be within the printable character (quotation marks or asterisks, for example). Substitute your own name, address, etc. in the appropriate areas. If you do not want to include some of the data on your form, do not enter the complete line.

Enter	Format
ALPHA	ALPHA
31;22;0;0;*ACME, INC*	
[R;][E;][Cn;][AFn;L;][T;][DIR;][UC;][DARK;][POINT;][HSn;]SR;SC;VE;HE;(D)text(D)	
32;22;0;0;*17500 CARTWRIGHT ROAD*	
33;22;0;0;*IRVINE, CA 92714*	
35.9;17;0;0;*SERIAL NUMBER*	
40.3;17;0;0;*PART NUMBER*	
40.3;50;0;0;*MFG. DATE*	
45.3;17;0;0;*DESCRIPTION*	
49.3;17;0;0;*INTERFACE*	
49.3;50;0;0;*VERSION*	
C13;31;16;0;0;*FROM:*	
C15;54;26;0;0;*Call PRINTRONIX for more information.*	
C15;55;34;0;0;*(714)863-1900*	
STOP	STOP

NOTE: The sample data entered above uses CP.DP format (such as 35.9, 40.3, etc.) in the starting row (*SR*) parameters. This precisely positions the data to avoid overlapping the alphanumeric data with the box and horizontal line data previously entered. For complete information on CP.DP format, refer to the Commands chapter.

At this point, the PRACTC.FRM file should contain the following form program data:

```
~CREATE;PRACTICE
BOX
2;35;16;53;61
STOP
CORNER
3;30;13;57;64;5;7
STOP
HORZ
1;40;16;61
1;45;16;61
1;49;16;61
STOP
VERT
1;49;40;45
1;49;49;53
STOP
ALPHA
31;22;0;0;*ACME, INC.*
32;22;0;0;*17500 CARTWRIGHT ROAD*
33;22;0;0;*IRVINE, CA 92714*
35.9;17;0;0;*SERIAL NUMBER*
40.3;17;0;0;*PART NUMBER*
40.3;50;0;0;*MFG. DATE*
45.3;17;0;0;*DESCRIPTION*
49.3;17;0;0;*INTERFACE*
```

```

49.3;50;0;0;*VERSION*
C13;31;16;0;0;*FROM:*
C15;54;26;0;0;*Call ACME for more information.*
C15;55;34;0;0;*(714)863-1900*
STOP
END
~EXECUTE;PRACTICE

~NORMAL
.PRINT PRACTC.FRM

```

Notice that the END, EXECUTE;PRACTICE and NORMAL statements are still in the file. These are always necessary to end the storage of the form in the IGP/PGL and cause it to print. Remember, a blank line must always separate the EXECUTE and NORMAL commands. Print the file PRACTC.FRM. The PRACTICE form should look like Figure 64, except for any alphanumeric data substitutions you made. Again, if error messages occur, refer to Solving Program Errors on page 289 .

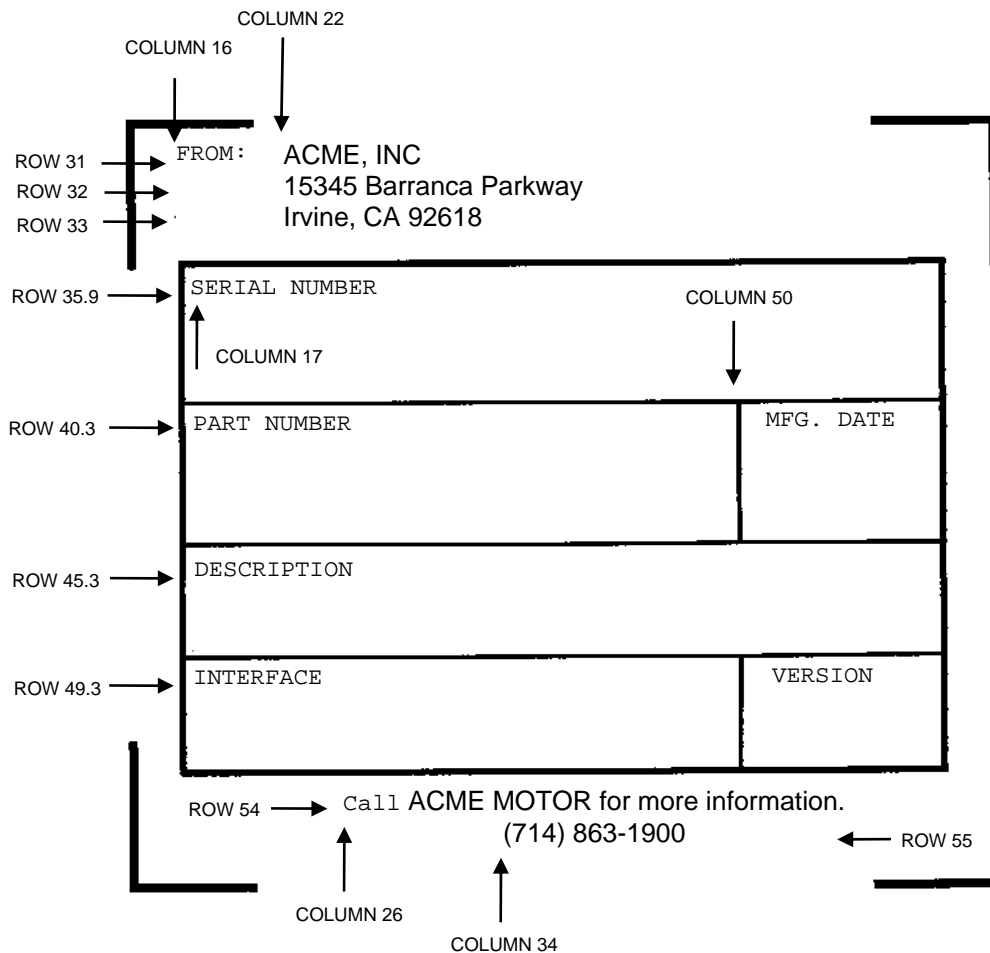

Figure 64 Practice Form Example

Adding A Bar Code

11. Change the form definition by adding bar code type Code 39 (C39), one of the codes available on the IGP/PGL. First, reopen the file. Bar codes are defined in the Create Form mode; therefore, the Bar Code command must be entered before the End command line. In the Bar Code command, specify type C39 and 0.8 inch height (Hn). Use a dynamic bar code data field (BF) identified by the number (n) 1 with a length (L) of 5. The actual data will be provided dynamically in the Execute Form mode. Specify the starting row (SR) 35.7 and starting column (SC) 39, and stop the command.

Enter	Format
BARCODE	BARCODE
C3/9;H8;BF1;5;DARK;35.7;39	C3/9[CD]; [DIR;] [MAG;] [Hn[.m];][BFn;L;][DARK;] SR;SC
STOP	STOP

12. To dynamically input alphanumeric data fields, first identify the locations for the data in the Create Form mode as part of the form definition. Enter the locations in the existing Alpha command sequence (or use a new Alpha command). In the Alpha command sequence, enter the alphanumeric field (AF), the field number (n), length (L), starting row (SR) and column (SC), and any vertical (VE) or horizontal (HE) expansion. To enter this alphanumeric data in the existing Alpha command sequence, the data must be entered before the existing Alpha command STOP line.

Enter	Format
AF1;7;38.7;19.3;3;3	[R;] [E;] [Cn;][AFn;L;][T;][DIR;][UC;][DARK;]
AF2;11;43;20;2;2	[POINT;][HSn;]SR;SC;VE;HE;(D)text(D)
AF3;31;47.3;20;2;1	
AF4;33;51.3;20;2;1	

13. Supply the dynamic data during the Execute Form mode (following the EXECUTE;PRACTICE line). Use the SFCC, specify the dynamic alphanumeric field (AF), bar code field (BF), the field number (corresponding to those just entered in the form definition), and the data itself. (This method can be repeated to supply new data to each form printed by separating the pages of data with a form feed. Refer to Execute Form: Dynamic Alphanumeric Data on page 61.)

Enter	Format
~AF1;*49114*	(cc)AFn;(D)data(D)
~AF2;*106772-902*	
~AF3;*INTELLIGENT GRAPHICS PROCESSOR*	
~AF4;*PARALLEL - CENTRONICS*	
~BF1;*49114*	(cc)BFn;(D)data(D)

14. Now the PRACTC.FRM file contains all the following information (the complete form program). Print the form by printing the file. The completed form is shown in Figure 65.

```
~CREATE;PRACTICE
BOX
2;35;16;53;61
STOP
CORNER
3;30;13;57;64;5;7
STOP
HORZ
1;40;16;61
1;45;16;61
1;49;16;61
STOP
VERT
1;49;40;45
1;49;49;53
STOP
```

```
ALPHA
31;22;0;0;*ACME, INC.*
32;22;0;0;*17500 CARTWRIGHT ROAD*
33;22;0;0;*IRVINE, CA 92714*
35.9;17;0;0;*SERIAL NUMBER*
40.3;17;0;0;*PART NUMBER*
40.3;50;0;0;*MFG. DATE*
45.3;17;0;0;*DESCRIPTION*
49.3;17;0;0;*INTERFACE*
49.3;50;0;0;*VERSION*
C13;31;16;0;0;*FROM:*
C15;54;26;0;0;*Call ACME for more information.*
C15;55;34;0;0;*(714)863-1900*
AF1;7;38.7;19.3;4;3
AF2;11;43;20;2;2
AF3;31;47.3;20;2;1
AF4;33;51.3;20;2;1 STOP
BARCODE
C3;9;H8;BF1;5;DARK;35.7;39
STOP
END
~EXECUTE;PRACTICE
~AF1;*49114*
~AF2;*106772-902*
~AF3;*INTELLIGENT GRAPHICS PROCESSOR*
~AF4;*PARALLEL - CENTRONICS*
~BF1;*49114*

~NORMAL
.PRINT PRACTC.FRM
```

FROM: ACME, INC
15345 Barranca Parkway
Irvine, CA 92618

COLUMN 19.3 COLUMN 39

SERIAL NUMBER		
49114		
PART NUMBER		MFG. DATE
106772-902		
DESCRIPTION		
INTELLIGENT GRAPHICS PROCESSOR		
INTERFACE		VERSION
PARALLEL - CENTRONICS		

Call ACME for more information.
(714)863-1900

Figure 65 Completed Practice Form Example

Logo Exercise

In this exercise, you will generate a logo. The following sample uses a hand logo. Using dot scaling (discussed in detail on page 95) on an 8-1/2 x 11- inch form, a hand was drawn on a grid, with each dot tabulated by row and column position. If a grid coordinate occupies half or more of a dot position, include that position in your logo program. (Grid samples are located in Appendix B.)

Each dot position used must be identified individually. However, you can use a hyphen between the starting and ending columns to indicate a section of consecutive dots. For example, this hand logo requires dots in row 1, columns 40-42, shown in Figure 66 below. A sequential row order is not required.

A logo is created and stored as an element in the definition of a form. For example, to use a logo, first design it in the Create Logo mode; then add it to a form in the Create Form mode; then execute the form (with the logo) in the Execute Form mode. The following logo exercise includes all three of these steps.

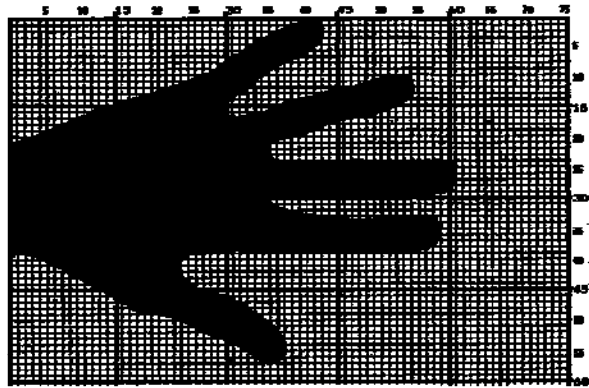

DOT POSITIONS

Row	Column
1	40-42
2	35-42
3	36-42
4	35-42
5	33-41
6	31-40
7	30-38
8	29-36
9	28-35
10	27-34;52-54
11	24-33;48-54
12	22-31;45-54
13	19-30;41-54
14	16-29;38-53
15	13-29;36-51
16	11-29;33-48
17	9-44
18	7-42
19	6-39
20	4-36
21	1-34
22	1-34
23	1-34
24	1-60
25	1-60
26	1-60
27	1-60
28	1-59
29	1-59
30	1-35

DOT POSITIONS

Row	Column
31	1-36
32	1-39
33	1-58
34	1-58
35	1-58
36	1-58
37	1-58
38	1-57
39	4-24
40	7-23
41	8-23
42	9-23
43	11-24
44	12-25
45	14-27
46	15-30
47	17-32
48	18-35
49	22-34
50	25-35
51	26-36
52	28-37
53	30-37
54	32-37
55	33-37
56	35-36

Figure 66 Sample Logo

Creating A Logo

1. Use your system commands to open a file for the logo program with the filename HNDLGO.FOM. For example:

Enter	Format
HNDLGO.FOM	(System Format)

2. Input the Special Function Control Code and Logo mode command to put the IGP/PGL in the Create Logo mode. Include HAND as the logo name; specify a vertical length (*VL*) of 56 (column length) and a horizontal length (*HL*) of 60 (row length).

Enter	Format
~LOGO;HAND;56;60	(cc)LOGO; <i>logoname</i> ;VL;HL[:DISK]

3. Enter each row of dot positions as tabulated from the grid and shown in Figure 66. The format is Row;Column (for example, 15;13-29;36-51). Each row is entered on a separate line. After all the dot positions are entered, terminate the Create Logo mode by entering an End command line.

4. Use the Special Function Control Code and Create command to create a form with the form name LEFTHAND. To add the logo to the form, input a Create Form mode Logo Call command, identify the logo starting row (*SR*) 45 and starting column (*SC*) 33, and specify the logo to use by its name (HAND). Stop the Logo command and end the Create Form mode.

Enter	Format
~CREATE;LEFTHAND	(cc)CREATE;[:] <i>formname</i> [:FL][:DISK]
LOGO	LOGO
45;33;HAND	SR;SC; <i>logoname</i> [:DISK]
STOP	STOP
END	END

5. Input the Special Function Control Code and Execute command for the LEFTHAND form just created. Input a blank line, the Special Function Control Code, and the Normal command to instruct the IGP/PGL to return to the Normal mode after execution.

Enter	Format
~EXECUTE;LEFTHAND	(cc)EXECUTE; <i>formname</i> [:PAGE <i>n</i>][:FC] [:DISK]
~NORMAL	(cc)NORMAL

6. Use system commands to exit the HNDLGO.FOM file and print. The finished program and logo should look like the following sample. If error messages occur, refer to Solving Program Errors on page 289.

```
~LOGO;HAND;56;60
1;40-42
2;38-42
3;36-42
4;35-42
5;33-41
6;31-40
7;30-38
8;29-36
9;28-35
10;27-34;52-54
11;24-33;48-54
12;22-31;45-54
13;19-30;41-54
14;16-29;38-53
15;13-29;36-51
16;11-29;33-48
```

```

17;9-44
18;7-42
19;6-39
20;4-36
21;1-34
22;1-34
23;1-34
24;1-60
25;1-60
26;1-60
27;1-60
28;1-59
29;1-59
30;1-35
31;1-36
32;1-39
33;1-58
34;1-58
35;1-58
36;1-58
37;1-58
38;1-57
39;4-24
40;7-23
41;8-23
42;9-23
43;11-24
44;12-25
45;14-27
46;15-30
47;17-32
48;18-33
49;22-34
50;25-35
51;26-36
52;28-37
53;30-37
54;32-37
55;33-37
56;35-36
END
~CREATE;LEFTHAND
LOGO
45;33;HAND
STOP
END
~EXECUTE;LEFTHAND

~NORMAL

```

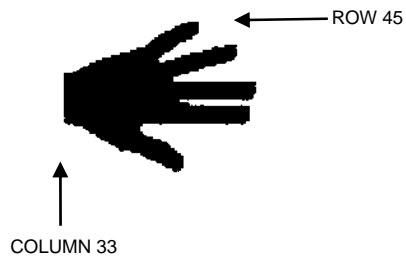

Form Design

In this exercise, you will produce a complete form by sketching it out on a grid in the same way the logo was designed. Again, this exercise uses character scaling on an 8-1/2 x 11-inch (60 x 72 dpi) page. (Refer to page 95 in the Commands chapter, where character scaling is discussed in detail.)

Page Layout Considerations

At 6 lines per inch (lpi) and 10 characters per inch (cpi) printing, a standard 8- 1/2 x 11-inch sheet of paper has a print area of 66 lines (rows) and 85 characters (columns). (The printable area will vary if you are not printing at 6 lpi and 10 cpi.) Thus, the grid used to design an 8-1/2 x 11-inch form should accommodate this 66 x 85 area. (Appendix 0 discusses the printable area for different form sizes in more detail.)

Using the grids provided in Appendix B, sketch out the form layout and identify the starting and ending values. These values will be used to input IGP/PGL command parameters.

Planning The Form Layout

In this example, assume you work for the HandCraft Boat Company. Your slogan is “Quality boats crafted by hand,” and the owner, Mr. Handcraft, has asked you to design a simple form that his salespeople can use for special orders. On the form, he wants a logo, the slogan, the customer's name, spaces for other particulars of the order, and a bar code to distinguish the sales region and boat division from other HandCraft enterprises. Begin this 12-step task as described below.

1. First, design the form on the Standard Grid provided in Appendix B. Figure 67 shows the locations of the various form components. Compensate for expanded characters and plan for the logo.
2. Define the logo and then return to the form to add all the form components. Modify the hand logo already on file as the HandCraft logo. Use the Logo Grid in Appendix B, and refer to Figure 68, which shows the dot positions of the hand logo with a boat added to the hand. When dot positions (or a range of dot positions) are not specified, the boat image in the hand emerges.
3. Open a file named HNDCFT.FOM to contain all the form information. As shown in the following example, use the Create Logo mode command, name the logo HANDCRFT, specify the logo height (VL) and width (HL), enter the dot positions used, and end the Logo command.

Enter

```
HNDCFT.FOM
~LOGO;HANDCRFT;56;60
1;40-42
2;38-42
3;36-42
4;35-42
5;33-41
6;31-40
7;30-38
8;29-36
9;28-35
10;27-34;52-54
11;24-33;48-54
12;22-31;45-54
13;19-30;41-54
14;16-29;38-53
15;13-17;19-29;36-51
16;11-17;20-29;33-48
17;9-17;21-44
18;7-17;22-42
19;6-17;22-39
```

Format

```
(System Format)
(cc)LOGO;logoname;VL;HL[;DISK]
row#;dot;dot1-dot2;dot
```

20;4-17;23-36
21;1-17;24-34
22;1-17;25-34
23;1-17;26-34
24;1-17;27-60
25;1-17;28-60
26;1-17;29-60
27;1-17;30-60
28;1-17;31-59
29;1-17;19-59
30;1-17;19-35
31;1-4;33-36
32;1-5;33-39
33;1-6;33-58
34;1-7;33-58
35;1-58
36;1-58
37;1-58
38;1-57
39;4-24
40;7-23
41;8-23
42;9-23
43;11-24
44;12-25
45;14-27
46;15-30
47;17-32
48;18-33
49;22-34
50;25-35
51;26-36
52;28-37
53;30-37
54;32-37
55;33-37
56;35-36
END

END

HandCraft Boats

CUSTOMER: _____ PHONE: _____

ROLL NO: _____ COMPANY: _____

COLOR: _____ DELIVERY DATE: _____

SPECIAL ORDER ITEMS

ITEM	DESCRIPTION	PRICE

SPECIAL ORDER
 SPECIAL ORDER
 SPECIAL ORDER

SPECIAL ORDER
 SPECIAL ORDER

Figure 67 Sample Form Design

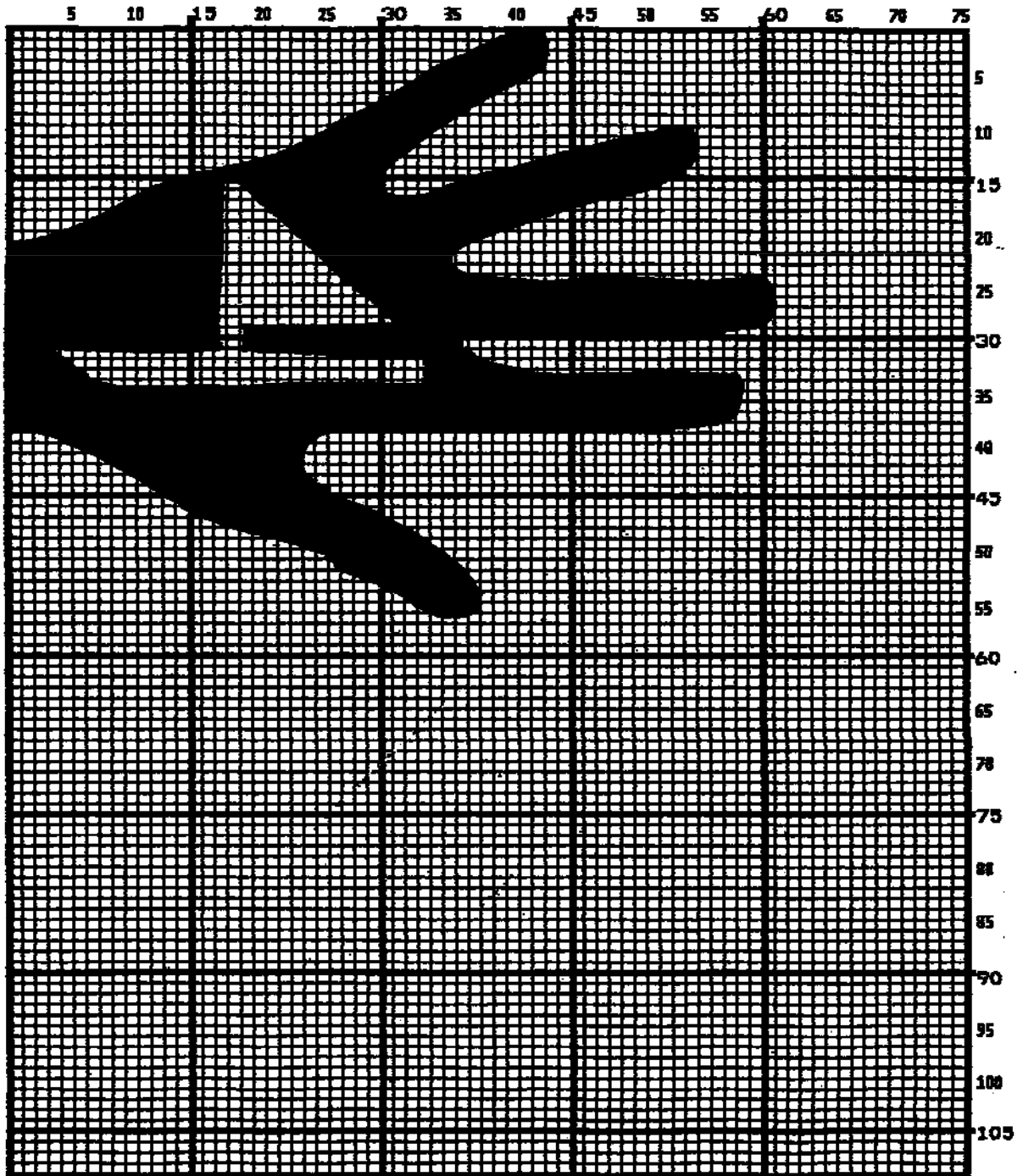

Figure 68 Logo Design

Creating A Form And Adding Form Components

4. Now create the form and start adding the form components from the layout grid. (Refer to Figure 67). Use the Special Function Control Code and Create command to define a form named HCBOATS. Use the Box command to define the outer border with a line thickness (*LT*) 3, top left corner at row (*SR*) 11 column (*SC*) 10, and bottom right corner at row (*ER*) 55, column (*EC*) 70. In the same Box command sequence, define another box with a line thickness of 2, top left corner at row 28 column 14, and bottom right corner at row 44.9 column 66. After defining the boxes, stop the Box command.

Enter	Format
~CREATE;HCBOATS	(cc)CREATE;[/] <i>formname</i> [/];FL];DISK]
BOX	BOX
3;11;10;55;70	<i>LT</i> ;SR;SC;ER;EC
2;28;14;44.9;66	
STOP	STOP

5. Mr. Handcraft would like corners around the slogan. Use the Corner command to define a line thickness (*LT*) of 2, top left corner at row (*SR*) 48 column (*SC*) 24, and bottom right corner at row (*ER*) 52 column (*EC*) 56. Make the vertical (*VL*) corner piece 4 spaces long and the horizontal (*HL*) corner piece 5 spaces long. Then stop the Corner command.

Enter	Format
CORNER	CORNER
2;48;24;52;56;4;5	<i>LT</i> ;SR;SC;ER;EC;VL;HL
STOP	STOP

6. To make the columns for the special order items, add two vertical lines each with a line thickness (*LT*) of 1, one line in column (*C*) 22 and the other line in column 58. Each line will start at row (*SR*) 28 and end at row (*ER*) 44.9.

Enter	Format
VERT	VERT
1;22;28;44.9	<i>LT</i> ;C;SR;ER
1;58;28;44.9	
STOP	STOP

7. To add the horizontal lines, define one line and then duplicate that line using the Vertical Duplication command. The line will have a single line thickness (*LT*), be in row (*R*) 30.4, starting in column (*SC*) 14 and ending in column (*EC*) 66. With vertical duplication, the line will be duplicated (*dup#*) 6 times with 2.5 row offset (*offset#*) spacing between each duplication. The Vertical Duplication command must be input, the horizontal line being duplicated must be input, and the Vertical Duplication command must be turned off.

Enter	Format
VDUP;6;2.5	VDUP; <i>dup#</i> ; <i>offset#</i>
HORZ	HORZ
1;30.4;14;66	<i>LT</i> ;R;SC;EC
STOP	STOP
VDUP;OFF	VDUP;OFF

8. All the text shown on the grid is fixed into position on the form with a single Alpha command sequence. The starting row, starting column, and text can be taken right from the grid and put into the program.

Enter	Format
ALPHA	ALPHA
14;31;3;2;*HandCraft Boats*	[R;][E;][C <i>n</i>][AF <i>n</i> ;L;][T;][DIR;][UC;][DARK;]
18;14;0;0;*CUSTOMER:*	[POINT;][HS <i>n</i>];SR;SC;VE;HE;(D) <i>text</i> (D)

```

18;51;0;0;*PHONE:*
20;14;0;0;*HULL NO:*
20;49;0;0;*RIGGING:*
22;14;0;0;*COLOR:*
22;43;0;0;*DELIVERY DATE:*
25;31;1;1;*SPECIAL ORDER ITEMS*
27;17;0;0;*ITEM*
27;34;0;0;*DESCRIPTION*
27;60;0;0;*PRICE*
50;26;1;1;*Quality Boats Crafted By Hand*
C17;48;14;0;0;*HandCraft Boats*
C17;48.10;14;0;0;*123 Boat Way*
C17;49.8;14;0;0;*Boat Town, CA*
C17;50.6;19;0;0;*333444*
C17;51.4;14;0;0;*(714)555-0011*
STOP                                STOP

```

9. HandCraft Boats uses bar code type Code 128B (C128B) in many applications. Use bar code C128B, height (Hn) of .5-inch, starting at row (SR) 49, column (SC) 59, code the West Coast Sales Region as *WC*, and print the data field (PDF) below the symbol.

NOTE: Due to space constraints, the C128B command below is separated into two lines. During actual input, *do not* separate the command parameters.

Enter	Format
BARCODE	BARCODE
C128B;H5;49;59	C128B;[DIR;][MAG;][Hn[.m];][BFn;L;] [DARK;]SR;SC
WC	[(D)datafield(D)]
PDF	[PDF;LOC[;FONT][;MAX]]
STOP	STOP

NOTE: The decimal point is not entered in the height parameter (H5) above because values are expected in .10-inch increments. Values from 4 to 99 (.4-inch to 9.9 inches) are accepted.

10. Add the logo and end the Create Form mode. Use the Logo Call command, specify the starting row (SR) at 12 and column (SC) at 18 as shown on the grid and call the logo by name (HANDCRFT). (The starting row and column of the logo refer to the upper left corner of the grid used in the logo design.)

Enter	Format
LOGO	LOGO
12;18;HANDCRFT	SR;SC;logoname[;DISK]
STOP	STOP
END	END

11. Execute the form (HCBOATS), return to the Normal mode (remember the blank line before the NORMAL command), exit the file using your system commands (if necessary), and print the document.

Enter	Format
~EXECUTE;HCBOATS	(cc)EXECUTE;formname[;PAGE n][;FC][;DISK]
~NORMAL	(cc)NORMAL
.PRINT HNDCT.FOM	(System Format)

NOTE: Always separate the EXECUTE and NORMAL commands by a line.

Figure 69 shows the finished form. If Mr. Handcraft would like to rearrange the words, change line thickness of a box, etc., simply reopen the file and change the appropriate command lines. Otherwise, his salespeople have a new form for notes on custom orders.



HandCraft Boats

CUSTOMER

HULL NO:

COLOR:

PHONE:

RIGGING:

DELIVERY DATE:

SPECIAL ORDER ITEMS

ITEM	DESCRIPTION	PRICE

HandCraft Boats
123 Boat Way
Boat Town, CA
332444
(714) 555-0011

Quality Boats Crafted By Hand



WC

Figure 69 Completed Sample Form

Directory Command

The Directory command lists the contents of the IGP/PGL directory on the host system. The directory command provides the following information:

- All form names currently defined
- All logo names currently defined
- The association of logos to forms
- The amount of memory used for form storage
- The amount of dynamic storage space used and available

Example

A form will not execute unless enough room exists in the memory as indicated in the Dynamic Memory Available portion of the directory listing. To print the directory, open a file, input the directory command, exit the file, and print. For example:

Enter	Format
DIRECT.FOM	(System Format)
~DIRECTORY	(cc)DIRECTORY
.PRINT DIRECT.FOM	(System Format)

The Directory command can only be used when the IGP/PGL is in the Normal mode. Upon completion of the directory listing, the IGP/PGL returns to the Normal mode. If the IGP/PGL is not in the Normal mode, input the Normal mode command before the Directory command. Figure 70 shows a sample directory.

```
Form Directory
Form Name      Form Size      Logos
MAXI.frm       7909
XO.frm         2210
PRSYM.frm      2210
UPCE.frm       812

Logos on File / Memory Used
PLANE.lgo      618
MK.lgo         886

Forms Memory Used..... 13141 bytes
Logo Memory Used..... 1504 bytes
Total Memory Used..... 14645 bytes
Dynamic Memory Available..... 4706048 bytes
```

Figure 70 Directory Example

Delete Command

The Delete command deletes any individual form or logo from the Onboard Flash Memory. The deletion of a form includes its directory entry and any alphanumeric or vector information associated with it. The Delete command is used only when the IGP/PGL is in the Normal mode.

Deletion of a logo includes its directory entry and its data in the logo storage area. Deletion of a valid logo which is still combined with a form will not cause an error at the time it is deleted; however, an error will occur if you execute a form that contains a previously deleted logo.

Example

From the directory printed in the preceding section, delete the practice form, the HandCraft Logo, and the HandCraft Boats form. Similar to the format used with other command sequences, the procedure is as follows: open a file, input the commands, exit the file, and print. For example:

Enter	Format
DELETE.FRM	(System Format)
~DELETE FORM;PRACTICE	(cc)DELETE FORM; <i>formname</i>
~DELETE FORM;HCBOATS	
~DELETE LOGO;HANDCRFT	(cc)DELETE LOGO; <i>logoname</i>
.PRINT DELETE.FRM	(System Format)

NOTE: List the directory again to verify that the forms and logos were deleted.

To delete a form or logo from the Onboard Flash Memory, add the DISK parameter to the above DELETE FORM or DELETE LOGO command:

```
~DELETE FORM;formname;DISK
```

```
~DELETE LOGO;logoname;DISK
```

A form cannot execute if insufficient space exists in the IGP/PGL memory. The directory Dynamic Memory Available must be greater than the total size (in bytes) of the form. Delete older forms or logos to allow memory space for new forms and logos, or include the Delete command as the last statement in a logo or form program to immediately delete the data after it is processed. Creating a form (or logo) with the same name as an existing IGP/PGL form (or logo) will automatically delete the existing form (or logo).

Solving Program Errors

If you make an error in the program to create a form or an element in the form, a coded error message and program line containing the error will print when the form is executed. These error codes are defined in the Error Codes chapter.

To solve program errors, perform the following steps:

Locate the error message in the listing provided in the Error Codes chapter for a description of the error.

Analyze the related portion of the program to find the error.

Correct the error and reprint the file containing the program.

If the error persists or you cannot locate it in the program, use the debug parameter [D] in the Create command as described in the Error Codes chapter. Print the file with the IGP/PGL program. The debug parameter lists the program, line by line (including the error on the line where the error occurs), followed by the error-free sections of the form. Correct the error and print the file again. When the error has been corrected, delete the debug parameter.

Example

Assume you made two errors in the Box and Corner commands input in steps 3 and 4 of the Form and Bar Code Example on page 270. Using the debug parameter in the Create command produces the following sample listing:

```
/PRACTICE
BOX
2;35;16:53;61
*** ERROR 24 : BOX format or delimiter error in input parameters
STOP
CORNER 3;300;13;57;64;5;7
*** ERROR 35 : CORNER vertical length VL out of bounds
*** ERROR 31 : CORNER starting row SR out of bounds
*** ERROR 39 : CORNER starting row SR > ending row ER
STOP
END
```

From the description of the error messages and the incorrect line identified by the error message, the errors are easily located and corrected. Notice a colon was accidentally input in the Box command where a semicolon was required (error number 24).

```
/PRACTICE
BOX
2;35;16:53;61
*** ERROR 24 : BOX format or delimiter error in input parameters
STOP
```

In the Corner command, the starting row was too large. This single input error caused the vertical length of the corner to extend beyond the form boundaries (error number 35), the starting row to begin outside the form boundaries (error number 31), and the starting/ending row parameters to be out of order (error number 39).

```
CORNER
3;300;13;57;64;5;7
*** ERROR 35 : CORNER vertical length VL out of bounds
*** ERROR 31 : CORNER starting row SR out of bounds
*** ERROR 39 : CORNER starting row SR > ending row ER
STOP
END
```

5 *Multinational And International Character Sets*

Multinational Character Sets

The Multinational Character Set accesses one of 32 international character sets. Each character set is 96 characters long and can be accessed by configuration selection or IGP/PGL command. Individual characters in the font can be accessed with the use of data bit 8. There are also 32 extended character sets which are available in bitmap fonts, but are not expandable.

Supported Character Sets

The Multinational Character Set provides the PGL with space for 32 character sets, 96 characters each. The character sets and their corresponding set values are listed in Table 41 along with the single extended character set.

Table 41 Multinational Character Sets and Set Values

Character Set	Value	Character Set	Value
U.S. ASCII	0	Spanish	9
German	1	Italian	10
Swedish	2	Turkish	11
Danish	3	CP 437	12
Norwegian	4	CP 850	13
Finnish	5	Reserved	14-23
English	6	User-Defined Sets	24-31
Dutch	7		
French	8		

Sets 0 through 13 are resident character sets. Sets 14 through 23 are reserved spaces in font memory for future resident character sets. If a value from 14 through 23 is called when attempting to choose a character set, the character font will default to ASCII. The last eight addressable character set values, 24 through 31, are reserved for user-defined sets. You can create custom character sets from existing characters in font memory. If you select a set value from 24 to 31 when no new character set has been created or assigned that value, the character font will default to ASCII.

Refer to page 303 for printouts of the primary and extended character sets and their corresponding values.

To select one of these sets using the "SYMSET" option of the font command or the ISET command, use the appropriate value as stated above.

Character Addresses

Both the ASCII and multinational character sets have hex values for each character and symbol. The primary character set (ASCII characters) resides at hex addresses ranging from 00 through 7F. The extended character set, which contains the multinational characters, resides at hex addresses ranging from 80 through FF. Table 43 shows each multinational character substitution hex value and the applicable ASCII hex values. To access the extended character set, the IGP/PGL must be configured with the data bit 8 option enabled.

Making Character Substitutions

Multinational character sets are created by substituting the multinational character values for the standard ASCII values. Each of the 12 multinational character sets allows up to 16 character substitutions (located at hex 21, 22, 23, 24, 25, 26, 40, 5B, 5C, 5D, 5E, 60, 7B, 7C, 7D, and 7E). The most common character substitutions specific to a particular country are provided in each set and shown in Table 43.

For example, when the Danish character set is selected, calling character address cell 5B substitutes the Danish character residing at C6 (Æ) from the Multinational Character Set (page 303); when the Spanish character set is selected, calling character address cell 7C substitutes the Spanish character residing at F1 (ñ) from the Multinational Character Set. These substitutions are automatically performed when a particular Multinational Character Set is selected.

Table 42 Multinational Character Sets and Set Values

	0XX Standard	1XX Arabic	2XX Cyrillic	3XX European	4XX Greek	5XX Hebrew	6XX Turkish	7XX Misc. ¹
NOTE: ¹ Applies to Line Matrix printers only.								
00	US ASCII	ASMO 449	Cyrillic 866	Latin 2 8859-2	DEC 256 Greek	Hebrew Old	Data Gen. Turk	Block-Set 10cpi
01	German	ASMO 449+	Cyrillic CP 437	Latin 2 852	ELOT 928 Greek	Hebrew New	DEC Turkish	Italics Set
02	Swedish	ASMO 708	Cyrillic 113	Mazovia	Greek 3	Hebrew DEC	IBM Turkish	Scanblock 10cpi
03	Danish	ASMO 708+	Cyrillic 8859-5	Kamenicky	ABY Greek	Latin-1 Hebrew	Siemens Turkish	PGL Thai Sets
04	Norwegian	MS DOS CP710	ISO 915	Roman 8	ABG Greek	Win. CP 1255	PTT Turkish	
05	Finnish	MS DOS CP720	Code Page 855	PC-437 Slavic	ELOT 927 Greek		IBC Turkish	
06	English	Sakr CP714	7-bit Cyrillic	Slavic 1250	Greek 851		Bull Turkish	
07	Dutch	Aptec CP715	Ukrainian	Code Page 865	Greek 437		AS400 Turkish	
08	French	CP 786	Bulgarian	Code Page 860	Greek 8859-7		Unisys Turkish	
09	Spanish	Arabic CP 864	Win. CP 1251	Latin 1 8859-1	Win. CP 1253		NCR Turkish	

Table 42 Multinational Character Sets and Set Values

	0XX Standard	1XX Arabic	2XX Cyrillic	3XX European	4XX Greek	5XX Hebrew	6XX Turkish	7XX Misc. ¹
10	Italian	Arabic CP 1046	Latvian 866	Latin 5 8859-9	Greek 813 Euro		PST Turkish	
11	Turkish	Arabic Lam 1	CP 1048	Latin 9 8859-15	Greek 869 Euro		Unis-1 Turkish	
12	CP 437	Arabic Lam 2		Polish POL1			Code Page 853	
13	CP 850	Win. CP 1256		Win. CP 1250			Info Turkish	
14	Reserved	Farsi 1		Win. CP 1252			Win. CP 1254	
15	Reserved	Farsi 2		Win. CP 1257			Code Page 857	
16	Reserved	1098 Farsi 1285		CP 858 Euro			Azeri	
17	Reserved			Lith. CP 773				
19	Reserved			Serbo Croatian 2				
20	Reserved			CP 774				
21	Reserved			CP 775				
22	Reserved			ISO 8859-4				
23	Reserved							
24-31	User Defined Sets							

Table 43 Substitution Set Hex Values

Character Set	Substitution Hex Value															
	21	22	23	24	25	26	40	5B	5C	5D	5E	60	7B	7C	7D	7E
U.S. ASCII																
Danish								C6	D8	C5		B0	E6	F8	E5	
Dutch			A3						80					81		
English			A3													
Finnish				A4				C4	D6	C5			E4	F6	E5	FC
French							E0	FB	E7	A7	F4	EA	E9	F9	E8	EE
German							A7	C4	D6	DC			E4	F6	FC	DF
Italian							A7	B0	E9	83		F9	E0	F2	E8	EC
Norwegian				A4			C9	C6	D8	C5	DC	E9	E6	F8	E5	FC
Spanish			82					C3	D1	D5	A1		E3	F1	F5	BF
Swedish				A4			C9	C4	D6	C5	DC	E9	E4	F6	E5	FC
Turkish	84	C7	E7	85				86	D6	DC	87	88	89	F6	FC	8A

Double Byte Character Set

The Double Byte Character set accesses one of the four double byte character sets: GB, Big5, Hangul KSC5601, and Kanji SJIS listed in Table 44.

Table 44 Double Byte Character Sets

	11xx DBCS
00	GB18030
01	Big5
02	KSC5601
03	Kanji SJIS

To select one of these sets using the SYMSET option in the font command or the ISET command, use the appropriate value in Table 44.

The GB18030 character set supports GB18030 quad byte encoding.

Accessing Characters and Character Sets

OCR Character Sets

Purpose Access OCR-A and OCR-B character sets.

Mode CREATE, NORMAL and EXECUTE

Format See Comments

Comments

In the Create mode, you can access OCR fonts using the alphanumeric command. Use the *Cn* parameter in the ALPHA command (Commands chapter, page 26) for more information.

In the Normal and Execute modes, you can access OCR fonts using the Compressed Print (Density) command (Commands chapter, page 43).

NOTE: OCR fonts are only available in 10 cpi.

Extended Character Sets

Purpose Access extended character sets.

Mode CREATE, NORMAL and EXECUTE

Format See Comments

Comments

In the Normal and Execute modes, you can access extended fonts using the ISET Command, page 297. Character sets 32 through 64 are extended character bitmap fonts which are not expandable.

NOTE: The extended character sets are bitmapped fonts and can not be expanded beyond 2 x 2. They are also limited to the portrait orientation.

Data Bit 8

You can access individual characters using data bit 8 addressing. The primary character set is ASCII. These character values reside at hex addresses 20 through 7F. The Multinational or extended character sets reside at hex addresses 80 through FF and are accessible without reconfiguration.

NOTE: Data bit 8 must be set high so that Multinational or extended character sets are accessible without reconfiguration. However, the PION/PIOFF command (page 82) must also be set OFF to access these character sets in the hex 80-FF range. A PION setting will cause data in the hex 80-FF range to be interpreted as PI line data instead of extended character set data.

Power-Up Character Set Selection

You can select any one of the 14 resident multinational character sets shown in Table 41 (0 through 13) or any of the International Sets shown in Table 47 as the default character set at printer power-up. The IGP/PGL configuration settings determine which character set is the default character set at power-up. Refer to your *Administrator's Manual* to configure the IGP/PGL for a specific character set. (See Select Font in the configuration menu.)

The character font selected at power-up will remain active until either the ISET or SYMSET command is selected or the configuration is changed. OCR and user-definable character sets cannot be configured as the default character set at printer power-up.

User-Defined Set Command (USET)

Purpose	Creates custom character sets (except OCR fonts) from existing characters stored on the flash memory.
Mode	NORMAL
Format	(cc)USET <i>n</i> <i>ca;fa</i> END
(cc)	Represents the Special Function Control Code.
USET	The User Set command; enter USET .
<i>n</i>	Selects USET character set number; enter a value ranging from 1 through 8 .
<i>ca</i>	Represents the ASCII character cell hex address which will have its contents replaced with the character located in the font address (<i>fa</i>). The <i>ca</i> value must be one of the 16 hex values specified in Table 43 on page 294.
<i>fa</i>	Represents the hexadecimal value for the font address of a specified character in the Multinational character set (page 303) which will replace the current contents of <i>ca</i> . The <i>fa</i> value is the character substitution for the cell address (<i>ca</i>). The value of <i>fa</i> may range from hex 20 through FF.
END	Ends the USET command.

Comments

You can define up to 16 character substitutions for each of the eight user-definable character sets. It is not necessary to address all 16 spaces available for character substitutions with a single USET command.

The character sets in the USET command are numbered 1 through 8. The character set values in the Character Set Selection (ISET) command (page 297) are numbered 24 through 31 and correspond to User Sets 1 through 8. The ISET command accesses and prints that custom character set.

The USET and ISET commands are related as shown in Table 45. Therefore, ISET;24 selects the substitution set defined as USET1, ISET;29 selects USET6, etc.

Table 45 USET-ISET Relationship

USET <i>n</i>	corresponds to	ISET; <i>n</i>
<i>n</i> = 1		<i>n</i> = 24
<i>n</i> = 2		<i>n</i> = 25
<i>n</i> = 3		<i>n</i> = 26
<i>n</i> = 4		<i>n</i> = 27
<i>n</i> = 5		<i>n</i> = 28
<i>n</i> = 6		<i>n</i> = 29
<i>n</i> = 7		<i>n</i> = 30
<i>n</i> = 8		<i>n</i> = 31

Example

The following example defines User Set 1 to contain the Multinational font addresses B1 (±), A1 (¡), and BF (¿) at the hex cell addresses 23, 24, and 25, respectively. Therefore, if *ca* = 23 and *fa* = B1, each time that cell address 23 is received, it will select the character located at font address B1 (±).

```
~USET1
23;B1
24;A1
25;BF
END
```

User Set 1 now contains the following: the plus or minus sign ± (hex B1) in place of the number sign # (hex 23); the upside down exclamation point ¡ (hex A1) in place of the dollar sign \$ (hex 24); and the upside down question mark ¿ (hex BF) in place of the percent sign % (hex 25). To print User Set 1, you must use the ISET command discussed on page 297.

Character Set Selection Command (ISET)

Purpose	Accesses one of the multinational (Table 41) or international (Table 47) character sets. Use this command to access a different character set from the configured power-up default character set.
Mode	NORMAL, CREATE, and EXECUTE
Format	In Normal and Execute modes: (cc)ISET; <i>n</i> or (cc)ISET;'UTF8' or ISET;'xx' In the Create mode (SFCC not required): ISET; <i>n</i> or ISET;'UTF8' or ISET;'xx'
(cc)	Represents the Special Function Control Code.
ISET	The Multinational Character Set command; enter ISET .
<i>n</i>	The character substitution set number; enter a value from the multinational (Table 41) or international (Table 47) character set tables. Character sets 0 through 23 represent resident character sets. Values from 24 through 31 correspond to the customized USET character sets 1 through 8, respectively. For example, refer to Table 45 on page 296. If you want to use the User Set 1 created in the example on page 297, call ISET;24. Similarly, if you want User Set 5 that you had previously defined, call ISET;28 to select and print the User Set 5 substitution set.
'UTF8'	Enter UTF8 enclosed with a single quote to select the UTF-8 character set, which is an encoding of Unicode.
'xx'	To select the alternate character sets, enter a two-byte string (listed in Table 46 on page 298) enclosed within single quotes.

NOTE: The two-byte string listed in Table 46 on page 298 depends on the font selected. For example, to select the Wingdings Character set, ISET;'WD', the wingding font needs to be selected with a FONT command.

Comments

You can issue the ISET command as many times within a form as needed. The character set selected will remain active until a new character set is selected. If you choose an incorrect character set value or make a syntax error, an error message will result. If a value for *n* is not specified, an error message will print.

Using the ISET command in the Execute mode declares the character set for use in conjunction with the dynamic data within that Execute command. Fixed form data specified in the Create mode is not affected by an ISET command in the Execute mode. The character set selected will remain in effect until another character set is selected.

NOTE: See the Fonts section in the Commands chapter, page 66, for information on the SYMSET command.

Table 46 Alternate Character Sets

Character Set Name	IF (Intelligent)	TT (TrueType)
Windows Symbol	AS	
ATMType1	AT	
ITC Zapf Dingbats/100	D1	
ITC Zapf Dingbats/200	D2	
ITC Zapf Dingbats/300	D3	
ISO 60: Danish/Norwegian	DN	DN
PS ITC Zapf Dingbats	DS	
DeskTop	DT	DT
ISO 8859/1 Latin 1 (EC94)	E1	E1
ISO 8859/2 Latin 2	E2	E2
ISO 8859/9 Latin 5	E5	E5
ISO 8859/10 Latin 6	E6	E6
ISO 69: French	FR	FR
ISO 21: German	GR	GR
ISO 15: Italian	IT	IT
Wingdings	L\$	WD
Legal	LG	LG
Math–8	M8	M8
Macintosh	MC	MC
PS Math	MS	MS
Microsoft Publishing	PB	PB
PC–8, Code Page 437	PC	PC
PC–8 D/N, Code Page 437N	PD	PD
PC–852 Latin 2	PE	PE
Pi Font	PI	PI
PC–850 Multilingual	PM	PM
PC–8 TK, Code Page 437T	PT	PT
PC–775 Baltic	PV	PV

Table 46 Alternate Character Sets

Character Set Name	IF (Intelligent)	TT (TrueType)
Non-UGL, Generic Pi Font		PY
Roman-8	R8	R8
ISO 17: Spanish	SP	SP
ISO 11: Swedish	SW	SW
Symbol		SY
PS Text	TS	TS
ISO 4: United Kingdom	UK	UK
ISO 6: ASCII	US	US
Ventura International	VI	VI
Ventura Math	VM	VM
Ventura US	VU	VU
Ventura 3.1 Latin 1	W1	W1
AgfaTidbits	WD	
Windows 3.1 Latin 2	WE	WE
Windows 3.0 Latin 1	WO	WO
Windows 3.1 Latin 5	WT	WT

Downloading A Block Character

- Purpose** The BLOCKLOAD command allows the user to replace a built-in block character with a user-defined downloaded block character.
- Mode** PGL NORMAL mode
- Format** NORMAL (cc)BLOCKLOAD[;DISK]
dest;data
END
 - (cc) Represents the Special Function Control Code (SFCC).
 - BLOCKLOAD The download/load Block character command.
 - DISK Optional parameter to store the downloaded character to the printer's non-volatile memory (FLASH) as well as its volatile memory (RAM). If the DISK parameter is not included, then the character would only be saved in RAM.

dest	The location (or address space) in which the character is to be saved. The location can be a used or unused location in the Character Table. The range is from 33 to 65,535 decimal. Locations 0 through 32 are control characters and the space character, which are non-replaceable characters.
data	The data in Block format represents the shape of the Block character. Only hexadecimal characters are allowed. The data must contain exactly 48 hexadecimal characters. The data must be followed by a line terminator.
END	Ends the BLOCKLOAD command.

Downloading A User-Defined Overlay Set

Purpose	The OSET command allows the user to create a user-defined overlay character set.
Mode	PGL NORMAL mode
Format	(cc)OSETn ca;fa END
(cc)	Represents the Special Function Control Code (SFCC).
OSET	The user-defined Overlay Set command.
n	Selects the overlay character set number. The range is from 1 to 8. The overlay set number 1 through 8 corresponds to the ISET character set selection 16 through 23.
ca	The ASCII character cell address in the current character set that will have its contents replaced by the character located in the font address (fa). The range is 33 through 255 decimal. Locations 0 through 32 are control characters and the space character, which are non-replaceable characters.
fa	The decimal address of the character (code point) in the character table that will replace the current contents of ca. The value may range from 33 to 65,535. Refer to the Character Table (Appendix C) in the LP+ Programmer's Reference Manual to determine which locations are used or unused. Addresses 0-32 are not allowed to avoid confusion between control characters and printable characters. Multiple ca;fa lines can be defined with a single OSET command.
END	Ends the OSET command.

NOTE: Only printable locations can be replaced. Control codes and the space character cannot be replaced. If the value of the cell address (ca) points to a control code or a space, then an error will print.

Activating A User-Defined Overlay Set

Purpose	An overlay set cannot be accessed until it is requested. Once a user-defined overlay set (Substitution Table) is created, the ISET command can be used to activate it. The ISET command can also be used to access regular (non-overlay) sets such as multinational or international character sets. If an overlay set selected has not been created, then the ISET command would have no effect on the currently selected character set.
Format	(cc)ISET;n
(cc)	Represents the Special Function Control Code (SFCC).
ISET	The character set command.

n The character set number. The valid values are 0 through 31. Overlay sets reside within sets numbered 16 through 23. All other values correspond to non-overlay sets.

Disabling An Overlay Set

The PGL overlay set is activated by the ISET command. It remains active until another character set is selected. When the character set is changed, all overlay sets will be disabled even if the selected set is the same as the previous base character set.

Examples for Downloaded Block Characters & Overlays

This section provides the available block patterns for creating a block character. Each character is composed of 24 bytes (NERF is 32 bytes), which is 48 nibbles of block patterns.

Available Block Patterns:

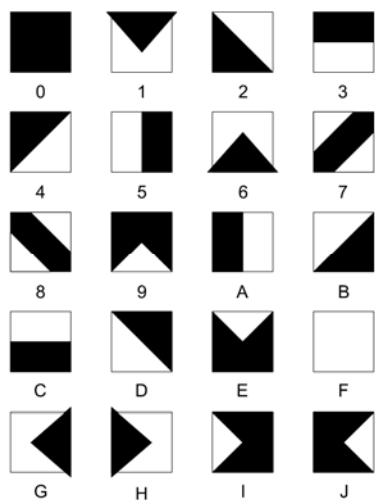

Example of Block Character 'A':

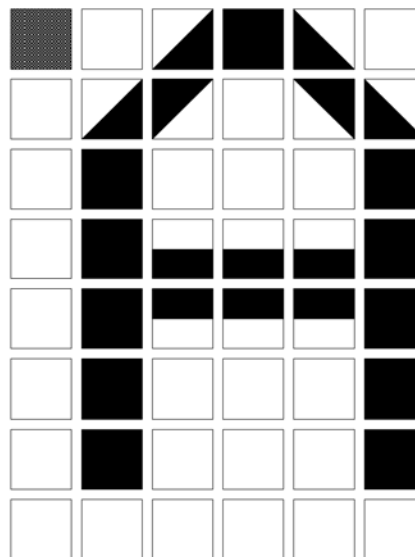

Figure 71 Using Block Patterns to Print Block Character A

The following example shows how to download, select, and print a user-defined block character (such as block character 'A' shown in Figure 71). It also shows a common error the user might encounter when creating overlay sets.

```
~NORMAL          NOTE: Puts PGL in Normal mode (default mode)
~BLOCKLOAD;DISK  NOTE: Download the Block '&' character to RAM and Flash
5000;0FB02F0B4FD200FFF000CCC000333000FFF000FFF000000
~END
```

```
~CONFIG          NOTE: Set Expanded Font menu option to Block
BLOCK FONTS;1
END
```

~OSET1 **NOTE:** Define overlay set #1
65;5000 **NOTE:** Overlay an 'A' character with the downloaded '&' character.
13;5000 **ERROR:** Cannot replace a Control Code.
END

~CREATE;Overlay **NOTE:** Create a PGL form
~ISET;16 **NOTE:** Enable overlay set #1
ALPHA
5;5;2;3;"A" **NOTE:** This prints out a '&' character instead of an 'A'.
STOP

ISET;0 **NOTE:** Selects U.S. ASCII character set. This command disables the overlay
set #1.
ALPHA
5;7;2;3;"A" **NOTE:** Prints an 'A' character (U.S. ASCII) STOP
END
~EXECUTE;Overlay;1

Setting The Expanded Font Menu Option

Purpose To access Block fonts in PGL, user needs to set the Expanded Font menu to Block. This can be done through the front panel or by using the configuration command BLOCK FONTS.

Format (cc)CONFIG
BLOCK FONTS;value
END

(cc) Represents the Special Function Control Code (SFCC).
CONFIG The configuration command.
BLOCK FONTS The configuration item.
value 0 to disable, non-zero to enable.

If an overlay set is active and the Expanded Font option is set to Block, the printer first checks the overlay set. The overlay characters have precedence over the base characters, except for control codes and the space character. If an overlay character exists for a particular cell, then that character will print in place of the character in the base character set.

Downloaded Font Menus

The Downloaded Font menu applies to both LP+ Bitmaps and IGP Block downloaded characters. For example, performing a Delete from Flash option deletes both Bitmap and Block downloaded characters from the flash memory. Refer to the *Administrator's Manual* for detailed descriptions of the menus and their functions.

Multinational Character Set Charts

IGP-50 MULTINATIONAL Set

	0	1	2	3	4	5	6	7	8	9	A	B	C	D	E	F
0		0	@	P	'	p	ij	⌘		°	À	Ð	à	ò		
1	!	1	A	Q	a	q	ij	■	ı	±	Á	Ñ	á	ñ		
2	"	2	B	R	b	r	pt		φ	²	Â	Ò	â	ò		
3	#	3	C	S	c	s		.	£	³	Ã	Ó	ã	ó		
4	\$	4	D	T	d	t	ll		¤	´	Ä	Ö	ä	ö		
5	%	5	E	U	e	u	ı		¥	µ	Å	Õ	å	õ		
6	&	6	F	V	f	v	Ğ	ğ		¶	Æ	Ö	æ	ö		
7	'	7	G	W	g	w			\$	·	Ç	×	ç	+		
8	(8	H	X	h	x	\$		"	.	È	Ø	è	ø		
9)	9	I	Y	i	y	\$	ı	⊙	ı	É	Ù	é	ù		
A	*	:	J	Z	j	z	İ		⊙	ı	Ê	Û	ê	û		
B	+	:	K	[k	{	ı		⊙	ı	Ë	Ü	ë	ü		
C	.	<	L	\	l		ı		⊙	ı	Ë	Ü	ë	ü		
D	-	=	M]	m	}	f		ı	ı	İ	ı	ı	ı		
E	.	>	N	^	n	~			ı	ı	İ	ı	ı	ı		
F	/	?	O	_	o				ı	ı	İ	ı	ı	ı		

ASCII THRU HOST COMMAND

	0	1	2	3	4	5	6	7
0		0	@	P	'	p		
1	!	1	A	Q	a	q		
2	"	2	B	R	b	r		
3	#	3	C	S	c	s		
4	\$	4	D	T	d	t		
5	%	5	E	U	e	u		
6	&	6	F	V	f	v		
7	'	7	G	W	g	w		
8	(8	H	X	h	x		
9)	9	I	Y	i	y		
A	*	:	J	Z	j	z		
B	+	:	K	[k	{		
C	.	<	L	\	l			
D	-	=	M]	m	}		
E	.	>	N	^	n	~		
F	/	?	O	_	o			

German THRU HOST COMMAND

	0	1	2	3	4	5	6	7
0		0	\$	P	'	p		
1	!	1	A	Q	a	q		
2	"	2	B	R	b	r		
3	#	3	C	S	c	s		
4	\$	4	D	T	d	t		
5	%	5	E	U	e	u		
6	&	6	F	V	f	v		
7	'	7	G	W	g	w		
8	(8	H	X	h	x		
9)	9	I	Y	i	y		
A	*	:	J	Z	j	z		
B	+	:	K	Ä	k	ä		
C	.	<	L	Ö	l	ö		
D	-	=	M	Ü	m	ü		
E	.	>	N	^	n	~		
F	/	?	O	_	o	Δ		

SWEDISH Set

	0	1	2	3	4	5	6	7
0			0	É	P	é	p	
1	!	1	A	Q	a	q		
2	"	2	B	R	b	r		
3	#	3	C	S	c	s		
4	¤	4	D	T	d	t		
5	¥	5	E	U	e	u		
6	&	6	F	V	f	v		
7	'	7	G	W	g	w		
8	(8	H	X	h	x		
9)	9	I	Y	i	y		
A	*	:	J	Z	j	z		
B	+	;	K	Ä	k	ä		
C	.	<	L	Ö	l	ö		
D	-	=	M	Å	m	å		
E	.	>	N	Ü	n	ü		
F	/	?	O	_	o			

DANISH Set

	0	1	2	3	4	5	6	7
0			0	@	P	°	p	
1	!	1	A	Q	a	q		
2	"	2	B	R	b	r		
3	#	3	C	S	c	s		
4	¤	4	D	T	d	t		
5	¥	5	E	U	e	u		
6	&	6	F	V	f	v		
7	'	7	G	W	g	w		
8	(8	H	X	h	x		
9)	9	I	Y	i	y		
A	*	:	J	Z	j	z		
B	+	;	K	Æ	k	æ		
C	.	<	L	Ø	l	ø		
D	-	=	M	Å	m	å		
E	.	>	N	^	n			
F	/	?	O	_	o			

NORWEGIAN Set

	0	1	2	3	4	5	6	7
0			0	É	P	é	p	
1	!	1	A	Q	a	q		
2	"	2	B	R	b	r		
3	#	3	C	S	c	s		
4	¤	4	D	T	d	t		
5	¥	5	E	U	e	u		
6	&	6	F	V	f	v		
7	'	7	G	W	g	w		
8	(8	H	X	h	x		
9)	9	I	Y	i	y		
A	*	:	J	Z	j	z		
B	+	;	K	Æ	k	æ		
C	.	<	L	Ø	l	ø		
D	-	=	M	Å	m	å		
E	.	>	N	Ü	n	ü		
F	/	?	O	_	o			

FINNISH Set

	0	1	2	3	4	5	6	7
0			0	@	P	·	p	
1	!	1	A	Q	a	q		
2	"	2	B	R	b	r		
3	#	3	C	S	c	s		
4	¤	4	D	T	d	t		
5	¥	5	E	U	e	u		
6	&	6	F	V	f	v		
7	'	7	G	W	g	w		
8	(8	H	X	h	x		
9)	9	I	Y	i	y		
A	*	:	J	Z	j	z		
B	+	;	K	Ä	k	ä		
C	.	<	L	Ö	l	ö		
D	-	=	M	Å	m	å		
E	.	>	N	^	n			
F	/	?	O	_	o			

ENGLISH Set

	0	1	2	3	4	5	6	7
0			0	@	P	.	p	
1		!	1	A	Q	a	q	
2		"	2	B	R	b	r	
3		£	3	C	S	c	s	
4		\$	4	D	T	d	t	
5		¥	5	E	U	e	u	
6		&	6	F	V	f	v	
7		'	7	G	W	g	w	
8		(8	H	X	h	x	
9)	9	I	Y	i	y	
A		*	:	J	Z	j	z	
B		+	:	K	[k	{	
C		.	<	L	\	l		
D		-	=	M]	m	}	
E		.	>	N	^	n	~	
F		/	?	O	_	o		

DUTCH Set

	0	1	2	3	4	5	6	7
0			0	@	P	.	p	
1		!	1	A	Q	a	q	
2		"	2	B	R	b	r	
3		£	3	C	S	c	s	
4		\$	4	D	T	d	t	
5		¥	5	E	U	e	u	
6		&	6	F	V	f	v	
7		'	7	G	W	g	w	
8		(8	H	X	h	x	
9)	9	I	Y	i	y	
A		*	:	J	Z	j	z	
B		+	:	K	[k	{	
C		.	<	L	\	l		
D		-	=	M]	m	}	
E		.	>	N	^	n	~	
F		/	?	O	_	o		

FRENCH Set

	0	1	2	3	4	5	6	7
0			0	à	P	ê	p	
1		!	1	A	Q	a	q	
2		"	2	B	R	b	r	
3		#	3	C	S	c	s	
4		\$	4	D	T	d	t	
5		¥	5	E	U	e	u	
6		&	6	F	V	f	v	
7		'	7	G	W	g	w	
8		(8	H	X	h	x	
9)	9	I	Y	i	y	
A		*	:	J	Z	j	z	
B		+	:	K	Ô	k	é	
C		.	<	L	Ç	l	ù	
D		-	=	M	\$	m	ê	
E		.	>	N	ô	n	î	
F		/	?	O	_	o		

SPANISH Set

	0	1	2	3	4	5	6	7
0			0	@	P	.	p	
1		!	1	A	Q	a	q	
2		"	2	B	R	b	r	
3		£	3	C	S	c	s	
4		\$	4	D	T	d	t	
5		¥	5	E	U	e	u	
6		&	6	F	V	f	v	
7		'	7	G	W	g	w	
8		(8	H	X	h	x	
9)	9	I	Y	i	y	
A		*	:	J	Z	j	z	
B		+	:	K	Ã	k	ā	
C		.	<	L	Ñ	l	ñ	
D		-	=	M	Õ	m	õ	
E		.	>	N	í	n	¿	
F		/	?	O	_	o		

ITALIAN Set

	0	1	2	3	4	5	6	7
0			0	\$	P	ù	p	
1		!	1	A	Q	a	q	
2		"	2	B	R	b	r	
3		#	3	C	S	c	s	
4		\$	4	D	T	d	t	
5		%	5	E	U	e	u	
6		&	6	F	V	f	v	
7		'	7	G	W	g	w	
8		(8	H	X	h	x	
9)	9	I	Y	i	y	
A		*	:	J	Z	j	z	
B		+	:	K	°	k	à	
C		.	<	L	é	l	ò	
D		-	=	M	ì	m	è	
E		.	>	N	^	n	î	
F		/	?	O	_	o		

TURKISH Set

	0	1	2	3	4	5	6	7
0			0	@	P	Ş	p	
1		İ	1	A	Q	a	q	
2		Ç	2	B	R	b	r	
3		ç	3	C	S	c	s	
4		ı	4	D	T	d	t	
5		%	5	E	U	e	u	
6		&	6	F	V	f	v	
7		'	7	G	W	g	w	
8		(8	H	X	h	x	
9)	9	I	Y	i	y	
A		*	:	J	Z	j	z	
B		+	:	K	Ğ	k	ş	
C		.	<	L	Ö	l	ö	
D		-	=	M	Ü	m	ü	
E		.	>	N	ğ	n	î	
F		/	?	O	_	o		

CP437 THRU HOST COMMAND

	0	1	2	3	4	5	6	7
0			0	@	P	'	p	
1		!	1	A	Q	a	q	
2		"	2	B	R	b	r	
3		#	3	C	S	c	s	
4		\$	4	D	T	d	t	
5		%	5	E	U	e	u	
6		&	6	F	V	f	v	
7		'	7	G	W	g	w	
8		(8	H	X	h	x	
9)	9	I	Y	i	y	
A		*	:	J	Z	j	z	
B		+	:	K	[k	{	
C		.	<	L	\	l		
D		-	=	M]	m	}	
E		.	>	N	^	n	~	
F		/	?	O	_	o	Δ	

CP850 THRU HOST COMMAND

	0	1	2	3	4	5	6	7
0			0	@	P	'	p	
1		!	1	A	Q	a	q	
2		"	2	B	R	b	r	
3		#	3	C	S	c	s	
4		\$	4	D	T	d	t	
5		%	5	E	U	e	u	
6		&	6	F	V	f	v	
7		'	7	G	W	g	w	
8		(8	H	X	h	x	
9)	9	I	Y	i	y	
A		*	:	J	Z	j	z	
B		+	:	K	[k	{	
C		.	<	L	\	l		
D		-	=	M]	m	}	
E		.	>	N	^	n	~	
F		/	?	O	_	o	Δ	

International Character Sets

The International Character Sets supported are listed in Table 47. Select these sets from the configuration menu “Select Font” option, or through the SYMSET option of the “FONT” command or the ISET command.

See Table 47 for a list of the Multinational Character Sets and their corresponding set values.

Table 47 International Character Sets

Character Set	Set Value	Character Set	Set Value
Standard Sets		Arabic Sets	
US ASCII	00	ASMO 449	100
German	01	ASMO 449+	101
Swedish	02	ASMO 708	102
Danish	03	ASMO 708	103
Norwegian	04	MS DOS CP 710	104
Finnish	05	MS DOS CP 720	105
English	06	Sakr CP 714	106
Dutch	07	Aptec CP 715	107
French	08	CP 786	108
Spanish	09	Arabic CP 864	109
Italian	10	Arabic CP 1046	110
Turkish	11	Arabic Lam 1	111
CP 437	12	Arabic Lam 2	112
CP 850	13	Win CP 1256	113
		Farsi 1	114
		Farsi 2	115
		1098 Farsi 1285	116
Cyrillic Sets		European Sets	
Code Page 866	200	Latin 2 8859-2	300
Cyrillic CP 437	201	Code Page 852	301
Cyrillic 113	202	Mazovia	302
Cyrillic 8859-5	203	Kamenicky	303
ISO 915	204	Roman 8	304
Code Page 855	205	PC-437 Slavic	305
7-bit Cyrillic	206	Slavic 1250	306
Ukrainian	207	Code Page 865	307
Bulgarian	208	Code Page 860	308
Win CP 1251	209	Latin 1 8859-1	309
Latvian 866	210	Latin 5 8859-9	310
CP 1048	211	Latin 9 8859-15	311
		Polish Pol 1	312
		Win CP 1250	313
		Win CP 1252	314
		Win CP 1257	315
		CP858 EURO	316
		Lith CP773	317
		Serbo Croatic1	318
		Serbo Croatic2	319
		CP 774	320
		CP 775	321
		ISO 8859-4	322

Table 47 International Character Sets

Character Set	Set Value	Character Set	Set Value
Greek Sets		Hebrew Sets	
DEC 256 Greek	400	Hebrew Old	500
ELOT 928 Greek	401	Hebrew New	501
Greek 3	402	Hebrew DEC	502
ABY Greek	403	Latin-1 Hebrew	503
ABG Greek	404	Win CP 1255	504
ELOT 927 Greek	405		
Greek 851	406		
Greek 437	407		
Greek 8859-7	408		
Win CP 1253	409		
Creek 813 EURO	410		
Greek 869 EURO	411		
Turkish Sets			
Data General Turkish	600		
DEC Turkish	601		
IBM Turkish	602		
Siemens Turkish	603		
PTT Turkish	604		
IBC Turkish	605		
Bull Turkish	606		
AS400 Turkish	607		
Unisys Turkish	608		
NCR Turkish	609		
PST Turkish	610		
Unis-1 Turkish	611		
Code Page 853	612		
INFO Turkish	613		
Win CP 1254	614		
Code Page 857	615		
Azeri	616		

6 *Error Codes*

IGP/PGL Emulation Error Codes

The IGP/PGL provides coded error messages to assist in “debugging” programs. The printer will print an error message number and the program line which contains the error when an error is detected. To help determine exactly where the error occurred, use the following debug command sequence:

`(CC)CREATE;/FORM NAME`

The slash (/) places the IGP/PGL in a debug mode, and the program prints, line by line, with the error number and message printed below the specific error in the program. The error-free portions of the form will print following the program. After correcting the error(s), print the file again. When the errors have been corrected, delete the slash. (A sample debug listing is shown in Solving Program Errors on page 289.)

In the Execute mode, that part of the form which was correctly defined and stored during the Create mode will print, including any dynamic data and overlay text which was accepted before the error occurred. (Sections containing errors must be corrected before storage in the Directory can take place.) Any error messages will print following the printed form, and processing will continue in the Normal mode.

In the Create Form or Create Logo mode, any error messages will print first, followed by that part of the form/logo which was correctly defined. Incorrectly defined elements are excluded from the form/logo.

The error codes are broken down into categories. In each category, the number preceding each error message is the actual error code reported by the printer, and the error shown in bold is the error message printed.

Horizontal Line Errors

- 01 **HORiZontal line starting row SR out of bounds**
The row specified by the second parameter in the horizontal line command places the horizontal line outside the boundaries of the form.
- 02 **HORiZontal line starting column SC out of bounds**
The left (starting) column of the horizontal line specified by the third parameter in the horizontal line command places the horizontal line outside the boundaries of the form.
- 03 **HORiZontal line ending column EC out of bounds**
The right (ending) column of the horizontal line specified by the fourth parameter in the horizontal line command places the horizontal line outside the boundaries of the form.
- 04 **HORiZontal line format or delimiter error**
Some type of format or delimiter error was detected in the parameters of the horizontal line command. This error is usually caused by one or more of the following:
- a. A missing semicolon;
 - b. A colon in place of a semicolon;
 - c. Too many or too few parameters in the command string;
 - d. Alpha characters instead of numeric characters in the parameters.
- 05 **Insufficient memory to store the HORiZontal line**
No more room in the IGP/PGL memory exists for another horizontal line. The rest of the horizontal line commands are flushed until the Stop command is found. Processing will then continue normally. To create space in the IGP/PGL memory, delete forms with horizontal line elements that are no longer required.
- 06 **HORiZontal line starting column SC > ending column EC**
The left (starting) column parameter of the horizontal line command is greater than or equal to the right (ending) column parameter.
- 07 **HORiZontal line thickness LT error**
The thickness of the horizontal line specified by the first parameter in the horizontal line command is incorrect. This error is usually caused by specifying a thickness of zero.
- 08-09 Not defined.

Vertical Line Errors

- 10 **VERTical line starting column SC out of bounds**
The column specified by the second parameter in the vertical line command places the vertical line outside the form boundaries.
- 11 **VERTical line starting row SR out of bounds**
The upper (starting) row of the vertical line specified by the third parameter in the vertical line command places the vertical line outside the boundaries of the form.
- 12 **VERTical line ending row ER out of bounds**
The lower (ending) row of the vertical line specified by the fourth parameter in the vertical line command places the vertical line outside the boundaries of the form.
- 13 **VERTical line format or delimiter error**
Some type of format or delimiter error was detected in the parameters of the vertical line command. This error is usually caused by one or more of the following:
- a. A missing semicolon;
 - b. A colon in place of a semicolon;
 - c. Too many or too few parameters in the command string;
 - d. Alpha characters instead of numeric characters in the parameters.
- 14 **Insufficient memory to store the VERTical line**
No more room in the IGP/PGL memory exists for another vertical line. The rest of the vertical line commands are flushed until the Stop command is found. Processing will then continue normally. To create space in the IGP/PGL memory, delete forms with vertical line elements that are no longer required.
- 15 **VERTical line starting row SR > ending row ER**
The upper (starting) row parameter of the vertical line command is greater than or equal to the lower (ending) row parameter.
- 16 **VERTical line thickness LT error**
The thickness of the vertical line specified by the first parameter in the vertical line command is incorrect. This error is usually caused by specifying a thickness of zero.
- 17-19 Not defined.

Box Errors

- 20 **BOX starting column SC out of bounds**
The left (starting) column specified by the third parameter in the box command places the box outside the form boundaries.
- 21 **BOX starting row SR out of bounds**
The upper (starting) row of the box specified by the second parameter in the box command will place the box outside the boundaries of the form.
- 22 **BOX ending column EC out of bounds**
The right (ending) column specified by the fifth parameter in the box command places the box outside the form boundaries.
- 23 **BOX ending row ER out of bounds**
The lower (ending) row of the box specified by the fourth parameter in the box command will place the box outside the boundaries of the form.
- 24 **BOX format or delimiter error in input parameters**
Some type of format or delimiter error was detected in the parameters of the box command. This error is usually caused by one or more of the following:
- a. A missing semicolon;
 - b. A colon in place of a semicolon;
 - c. Too many or too few parameters in the command string;
 - d. Alpha characters instead of numeric characters in the parameters.
- 25 **Insufficient memory to store the BOX**
No more room in the IGP/PGL memory exists for another box. The rest of the box commands are flushed until the Stop command is found. Processing will then continue normally. To create space in the IGP/PGL memory, delete forms with box elements that are no longer required.
- 26 **BOX starting column SC > ending column EC**
The left (starting) column parameter of the box command is greater than or equal to the right (ending) column parameter.
- 27 **BOX starting row SR > ending row ER**
The upper (starting) row parameter of the box command is greater than or equal to the lower (ending) row parameter.
- 28 **BOX line thickness LT error**
The thickness of the box specified by the first parameter in the box command is incorrect. This error is usually caused by specifying a thickness of zero.
- 29 **Box radius index out of range.** The optional parameter, round corner radius index, specified by the last parameter in the box command is out of range.

Corner Errors

30 **CORNER starting column SC out of bounds**

The left (starting) column specified by the third parameter in the corner command places the corner outside the form boundaries.

31 **CORNER starting row SR out of bounds**

The upper (starting) row of the corner specified by the second parameter in the corner command will place the corner outside the boundaries of the form.

32 **CORNER ending column EC out of bounds**

The right (ending) column specified by the fifth parameter in the corner command places the corner outside the form boundaries.

33 **CORNER ending row ER out of bounds**

The lower (ending) row of the corner specified by the fourth parameter in the corner command will place the corner outside the boundaries of the form.

34 **CORNER horizontal length HL out of bounds**

The length of the horizontal arms of the corner specified by the seventh parameter in the corner command will cause parts of the corner to extend outside the form boundaries.

35 **CORNER vertical length VL out of bounds**

The length of the vertical arms of the corner specified by the sixth parameter in the corner command will cause parts of the corner to extend above or below the boundaries of the form.

36 **CORNER format or delimiter error in input parameters**

Some type of format or delimiter error was detected in the parameters of the corner command. This error is usually caused by one or more of the following:

- a. A missing semicolon;
- b. A colon in place of a semicolon;
- c. Too many or too few parameters in the command string;
- d. Alpha characters instead of numeric characters in the parameters.

37 **Insufficient memory to store the CORNER**

No more room in the IGP/PGL memory exists for another corner. The rest of the corner commands are flushed until the Stop command is found. Processing will then continue normally. To create space in the IGP/PGL memory, delete forms with corner elements that are no longer required.

38 **CORNER starting column SC > ending column EC**

The left (starting) column parameter of the corner command is greater than or equal to the right (ending) column parameter.

39 **CORNER starting row SR > ending row ER**

The upper (starting) row parameter of the corner command is greater than or equal to the lower (ending) row parameter.

Alpha Errors

40 **ALPHA leading and trailing delimiters mismatched**

The leading delimiter (printable character) of the actual text string was not matched with an ending delimiter before the line terminator was found.

41 **ALPHA starting row SR out of bounds**

The starting row parameter in the Alpha command will cause the text string to print either above or below the limits of the form.

NOTE: Expanded print text strings expand up from the specified row. This could cause an attempt to print the text string above the top of the form and generate the error message.

42 **ALPHA starting column SC out of bounds**

The starting column parameter in the Alpha command is either extending the alpha string beyond the left margin of the form or the starting column parameter, plus the actual length of the text is extending the string beyond the right margin of the page.

43 **ALPHA string length > 255 characters**

The string contains more than 255 characters.

44 **ALPHA format or delimiter error in input parameters**

Some type of format or delimiter error was detected in the parameters of the alpha command. This error is usually caused by one or more of the following:

- a. A missing semicolon;
- b. A colon in place of a semicolon;
- c. Too many or too few parameters in the command string;
- d. Alpha characters instead of numeric characters in the parameters.

45 **Insufficient memory to store the ALPHA string**

No more room in the IGP/PGL memory exists for another alpha string. The rest of the Alpha commands are flushed until the Stop command is found. Processing of the form will then continue normally. To create space in the IGP/PGL memory, delete forms with alpha string elements that are no longer required.

46 **ALPHA X expansion HE and Y expansion VE must be zero**

When the expanded character parameters *VE* and *HE* are used within the ALPHA command, both values must be either zero or non-zero values. Use vertical expansion and horizontal expansion with 12 point font size only. If the elongated characters parameter [*E*] or the compressed characters parameter [*Cn*] is used in the ALPHA command, the *VE* and *HE* values must be set to 0.

47 **ALPHA X expansion factor HE out of bounds**

The horizontal expansion factor is greater than the maximum allowed.

48 **ALPHA Y expansion factor VE out of bounds**

The vertical expansion factor is greater than the maximum allowed.

49 **ALPHA compression factor Cn or Density error (10, 10A, 10B, 12, 13, 15, 17, 20)**

The optional compression parameter (*Cn*) which defines the horizontal pitch of the text was specified incorrectly. The pitches currently available are 10, 10A, 10B, 12, 13, 15, 17, and 20 cpi.

Logo Errors

- 50 **LOGO horizontal width HL > 240 or dot col> HL**
- a. The horizontal width of the logo is equal to zero or greater than 240. The IGP/PGL automatically reverts to Normal mode when this occurs.
 - b. A dot position specified in the logo program exceeds the specified horizontal width of the logo. When this occurs, the buffer is flushed until a line terminator is found, and then logo construction continues normally.
- 51 **LOGO vertical length VL > 252 or dot row n > VL**
- a. The vertical length of the logo is equal to zero or greater than 252. The IGP/PGL automatically reverts to Normal mode when this occurs.
 - b. A dot row specified in the logo program exceeds the specified vertical length of the logo. When this occurs, the buffer is flushed until a line terminator is found, and then logo construction continues normally.
- 52 **LOGO hyphen syntax error in input parameters**
- The beginning or ending dots are out of order, or a parameter is missing. The buffer is flushed until a line terminator is found, and then logo construction continues normally.
- 53 **Insufficient memory to create the LOGO**
- No more room exists in IGP/PGL memory to construct a logo for the size specified. When this occurs, the IGP/PGL automatically reverts to Normal mode. To create space in IGP/PGL memory, delete forms with logo elements (including the logos) that are no longer required.
54. **LOGO format or delimiter error**
- Some type of format or delimiter error was detected in the Logo command. If this occurs while specifying the size and name of the logo, the IGP/PGL automatically reverts to the Normal mode. If this occurs during the actual construction of the logo, the buffer is flushed until a line terminator is found, and then logo construction continues normally.
- 55 **LOGO call not previously defined**
- An attempt was made in the Create Form mode to incorporate an undefined logo into a form. This error is not generated during the Logo Form mode. When this error occurs, the buffer is flushed until a line terminator is found, and then forms creation continues normally.
56. **Insufficient memory for another LOGO call**
- IGP/PGL memory cannot store another logo call. To create space in the IGP/PGL memory, delete forms with logo elements (including the logos) no longer required.
57. **LOGO call starting row SR out of bounds**
- During form creation, the parameter specifying the row position of a logo places the logo outside the form boundaries. The buffer is flushed until a line terminator is found, and then processing continues normally.
58. **LOGO call starting column SC out of bounds**
- During form creation, the parameter specifying the column position of a logo places the logo outside the form boundaries. When this occurs, the buffer is flushed until a line terminator is found, and then processing continues normally.
59. **LOGO error found in DISK/FLASH file**
- When the logo was loaded dynamically in Execute Form mode from disk or flash, there was an error in processing the logo.

Create Errors

- 60 **Directory full - cannot CREATE the form or LOGO**
The directory is full, or no more room exists in the IGP/PGL memory for another form. When this occurs, the IGP/PGL automatically reverts to the Normal mode. To create space in the IGP/PGL memory, delete forms that are no longer required.
- 61 **CREATE function unrecognized**
An unrecognizable command is entered during the Create Form mode. At this point, the buffer is flushed until a Stop command is found, and then processing continues.
- 62 **CREATE horizontal duplication parameter HDUP error**
Either a format error was detected or a parameter was exceeded. The duplication number must be no greater than 255, and the offset must be no greater than 792 (dot scale). If this error occurs, the Horizontal Duplication command is ignored, and forms processing continues.
- 63 **CREATE vertical duplication parameter VDUP error**
Either a format error was detected, or a parameter was exceeded. The duplication number must be no greater than 255 and the offset must be no greater than the specified length of the form. If this error occurs, the Vertical Duplication command is ignored, and forms processing continues.
- 64 **CREATE scale factor parameter SCALE invalid**
Either a format error was detected, or a parameter was specified incorrectly. The vertical lines per inch can be specified as 1 to the target DPI. The horizontal characters per inch can be specified only as 10, 12, 13, 15, 17 or 20 cpi. If this error occurs, the Scale command is ignored and forms processing continues.
- 65 **CREATE page starting row PAGE SR out of bounds**
When you specify the position of the page parameters with the Page command in the Create Form mode, the row position specified will place the page number above or below the boundaries of the form. When this error occurs, the IGP/PGL will automatically revert to the Normal mode.
- 66 **CREATE page starting column PAGE SC out of bounds** When you specify the position of the page parameters in the Create command, the column position specified will place the page number outside the form boundaries. When this error occurs, the IGP/PGL will automatically revert to the Normal mode.
- 67 **CREATE STOP command missing**
This error occurs when the IGP/PGL receives a new function command, an End command, or a mode command without receiving a Stop command. The IGP/PGL will continue to process subsequent commands correctly.
- 68 **Insufficient memory to store the SETUP program**
No more room in the IGP/PGL memory exists for storing the SETUP routine.
- 69 **Insufficient memory to store the form**
The directory is full, or no more room exists in the IGP/PGL memory for another form. When this occurs, the IGP/PGL automatically reverts to the Normal mode. To create space in the IGP/PGL memory, delete forms that are no longer required.

Execute Errors

- 70 **EXECUTE form count parameter FC error**
This error occurs when the parameter specifying the number of blank forms to print was entered incorrectly. When this error occurs, the IGP/PGL will automatically revert to the Normal mode. Form count can be from 1 through 65,535.
- 71 **EXECUTE/DELETE form or file not found in the directory**
An attempt was made to execute or delete a form which does not exist in the forms directory. When this error occurs, the IGP/PGL reverts to the Normal mode.
- 72 **EXECUTE EVFU load error**
This error is generated only during the Execute Form mode while programming the EVFU. If more channels than lines per physical page are specified during a load sequence, this error is generated, and the IGP/PGL automatically reverts to the Normal mode.
- 73 **EXECUTE EVFU terminator invalid**
This error is generated only during the Execute Form mode. The EVFU LOAD is missing an END LOAD code. If the line terminator cannot be deciphered, an error is generated, and the IGP/PGL reverts to the Normal mode.
- 74 **Missing delimiter - must be a single quotation mark**
When issuing an SFCC change command, the new SFCC character must be contained within two single quotation marks. If the new SFCC character is being identified by the ASCII value, no quotation marks are required.
- 75 Not defined.
- 76 **EXECUTE page number error**
An error was made while specifying the page number used with the form being executed. This error can be generated because of incorrect format or a page number that is too large. The specified page number can range from 0 through 99,999,999. Since the page number is part of the Execute command, the IGP/PGL will automatically revert to the Normal mode.
- 77 **EXECUTE format or delimiter error**
A format or delimiter error was detected in the Execute command; the IGP/PGL will automatically revert to the Normal mode. This error is usually caused by one or more of the following:
- a. A missing semicolon;
 - b. A colon in place of a semicolon;
 - c. Too many or too few parameters in the command string;
 - d. Alpha characters instead of decimal digits in the parameters;
 - e. Page command misspelled when specifying the page number.
- 78 **Insufficient memory to EXECUTE the form**
Insufficient memory was available to recall and execute a form. The IGP/PGL will automatically revert to the Normal mode.
- 79 Not defined.

Miscellaneous Errors

- 80 **Special function must be called from the NORMAL mode**
This special function must be called from the Normal mode and not the Create Form or Execute Form mode. This error is generally due to a missing End command in the Create Form mode. For example, an attempt to enter the Create Form mode while executing a form will cause the IGP/PGL automatically to revert to the Normal mode.
- 81 **No such special function**
The special function call was unrecognizable. The IGP/PGL will automatically revert to the Normal mode.
- 82 **Numeric value expected in input parameter**
Characters other than numeric digits (0-9) are encountered where digits are expected.
- 83 **Decimal input error in input parameter**
The parameter expected was a decimal number. Either the number was not there, or it was too large (greater than 65,535). This error can also be caused by entering an alpha character instead of a numeric character.
- 84 **Missing or wrong delimiter - must be a semicolon ;**
The delimiter is either wrong or missing. The delimiter expected is a semicolon.
- 85 **Missing or wrong delimiter - must be a colon :**
- 86 **DENSITY param error - 10, 10A, 10B, 12, 13, 15, 17, or 20**
The parameters of the Density command are improperly specified. The densities currently implemented are 10, 10A, 10B, 12, 13, 15, 17, and 20 characters per inch. The command is ignored and processing continues.
- 89 **LPI parameter error**
The parameters of the LPI command are improperly specified. The allowable range is from 1 through 1000. The command is ignored and processing continues.
- 88 **BARCODE type not supported**
The bar code type selected is a valid IGP/PGL bar code, but is not supported by this type of printer.
- 89 **EXPAND parameters out of bounds or format error**
The parameters of the Expand command are improperly specified. Either the parameters are out of bounds, or some type of format error was detected. The command is ignored, and processing continues.

Bar Code Errors

- 90 **Insufficient memory to store the BARCODE**
No more room exists in the IGP/PGL memory for another bar code. The rest of the bar code commands are flushed until the Stop command is found. Processing will then continue.
- 91 **ALPHA/BARCODE syntax error**
Some type of syntax (format) error was detected in the parameters of the bar code command. This error is usually caused by one or more of the following:
- a. Misspelled keywords;
 - b. Lowercase used;
 - c. A missing semicolon;
 - d. A colon in place of a semicolon;
 - e. An ending delimiter for the data field was not found;
 - f. Too many or too few parameters in the command string.
- The rest of the command line is flushed until the Stop command is found. Processing will then continue.
- 92 **BARCODE magnification factor MAG out of bounds or not allowed**
The magnification factor specified in the bar code command is out of bounds. Refer to the applicable section in the Bar Codes chapter to determine the acceptable magnification values for the bar code symbol being used.
- 93 **BARCODE starting row SR out of bounds**
The starting row parameter in the bar code command will cause the bar code symbol to print either above or below the limits of the form.
- 94 **BARCODE starting column SC out of bounds**
The starting column parameter in the bar code command will cause the bar code symbol to print either beyond the left margin or the right margin of the form.
- 95 **BARCODE height Hn out of bounds**
The height parameter specified in the bar code command is out of bounds. Acceptable values vary based on the barcode symbology. See Chapter 3 for the allowable height range.
- 96 **BARCODE data field has illegal character/format**
A character in the data field was not recognized as an acceptable character. Refer to the applicable section in the Bar Codes chapter to determine the acceptable characters for the bar code symbol being used. The missing ending delimiter also causes this error.
- 97 **BARCODE data field too short or too long**
The data field in the bar code command has too few or too many data characters. Refer to the applicable section in the Bar Codes chapter to determine the acceptable number of data characters for the bar code symbol being used.
- 98 **BARCODE symbol(s) exceeds the form length**
The bar code command causes a bar code symbol to print below the limits of the form. This error occurs on the data field line of the bar code.
- 99 **BARCODE symbol(s) exceeds the form width**
The bar code command causes a bar code symbol to print beyond the right margin. This error occurs on the data field line of the bar code.

- 100 **BARCODE variable ratio 0 or not ascending**
- 101 **BARCODE PDF not allowed or error - LOC: A or B - FONT: N, P, Q, R, T, V, O, X or S**
The alternate font was selected for a barcode, an invalid parameter was used, or the selected height of the barcode cannot fit a PDF. Either the alternate font was selected for a barcode or an invalid parameter was used. Acceptable parameters must be "N" for the normal font, "O" for the OCR-A optional font, "X" for the OCR-B optional font, or "S" to suppress printing of the data field, "P" for 12 cpi, "Q" for 13 cpi, "R" for 15 cpi, "T" for 17 cpi, "V" for 20 cpi.
- 102 **Dynamic BARCODE symbol exceeds the form length**
The bar code command with a dynamic data field exceeds the limits of the current form length.
- 103 **Dynamic data must be inserted at Top-of-Form**
Dynamic data must immediately follow the EXECUTE command before any overlay data.
- 104 **Dynamic BARCODE data field BF_n not previously defined**
Dynamic data field designated in the Execute Form mode was not defined in the Create Form mode.
- 105 **Dynamic ALPHA/BARCODE/LOGO field AF_n/BF_n/GF_n error - must be 0-512**
Dynamic alpha field number (AF_n), bar code field number (BF_n), or logo field number (GF_n) must range from 0 through 512.
- 106 **Dynamic BARCODE symbol exceeds the form width**
- 107 **Dynamic ALPHA data field AF_n not previously defined** The dynamic alpha field number called for was not previously defined in the Create Form mode.
- 108 **BARCODE symbol check digit CD out of bounds**
- 109 **Dynamic Alpha/BARCODE field longer than previously defined**
The BARCODE data provided exceeds the maximum length for the bar code selected.
- 110 **SFCC decimal input error - must be 01 - 255**
The hexadecimal value on the ASCII chart for the Special Function Control Code is not valid. Refer to page 101 to select a valid SFCC.

Reverse Print Errors

- 111 **REVERSE format error in input parameters**
Re-enter the command with proper format.
- 112 **REVERSE starting row SR/ending row ER out of bounds**
Exceeds the value specified to reverse the element.
- 113 **REVERSE starting SC/ending column EC out of bounds**
Exceeds the value specified to reverse the element.
- 114 **Insufficient memory to store the REVERSE element**
Insufficient memory space available for reversed print requirements.

Miscellaneous Errors

- 115 **PDF417 barcode sizing parameter illegal or too small for data.**
- 116 **PDF417 security level has illegal value or format**
- 117 **Unusable or illegal raster data**
- 118 **Unsupported raster image type**
- 119 **Unsupported raster compression type**
- 120 **Dynamic LOGO data field GFn not previously defined.**
Dynamic logo field designated in the Execute Form mode was not defined in the Create Form mode.
- 121 Not defined.
- 122 **EXECUTE form too wide for current page setting**
The form was defined in one orientation while sent to print in another orientation. Use the debug slash (/) when creating a form to show which element is out of bounds (see page 337).
- 123 **EXECUTE form too long for current page setting**
The form was defined in one orientation while sent to print in another orientation. Use the debug slash (/) when creating a form to show which element is out of bounds (see page 337).
- 124-125 Not defined.
- 126 **LFORMx form length parameter n error**
The number of lines exceeds 66 (for 6 lpi) or 88 (for 8 lpi) lines when using the LFORMx command.
- 127 Not defined.
- 128 **FORM/LOGO name is not a legal file name**
The file name exceeds the 15-character limitation, or an invalid character was used in the file name. Refer to IGP/PGL Command Standards in the Commands chapter.
- 129 Not defined.

Incremental Fields Errors

- 130 Not defined.
- 131 **Incremental STEPMASK parameter error**
A semicolon is missing after the STEPMASK data.
- 132 **Incremental REPEAT/RESET parameter error**
An illegal RPT or RST parameter value was found in the incremental command. The value must range from 1 through 65,535.
- 133 **Incremental STEPMASK/STARTDATA length error**
The dynamic stepmask exceeded created field length or start data exceeded stepmask.
- 134 **Incremental EXECUTE command error**
An illegal IRST or ICNT parameter value was found in the Execute command. The value must range from 1 through 65,535.
- 135 Not defined.
- 136 **Incremental STEPMASK/STARTDATA mismatched**
The STARTDATA value must be A-Z or 0-9, when the STEPMASK value is a value from 0-9.

Miscellaneous Errors

- 137 **Data Matrix barcode sizing parameter illegal or too small for data**
- 138 **Data Matrix barcode format ID parameter is illegal**
- 139 **Data Matrix barcode ECC type is illegal**
- 140 **PMODE or SMODE not the first command in the CREATE mode**
- 141 **PMODE or SMODE syntax error**
- 142 **PMODE or SMODE printer type PT parameter error**
- 143 **PMODE or SMODE scaling parameter error**
- 144 **PMODE or SMODE exit mode (EM) parameter error**
- 145 **PMODE entries exceeded - maximum = 8**
- 146 - 149 Not defined.

Multinational Character Set Errors

- 150 **ISET character selection parameter n error**
An ISET character set selection parameter value between 0 and 31 or 1100 to 1103 was expected. Error was caused possibly by an invalid numeric value or an alpha character. See Chapter 5.
- 151 **USET decimal input error in input parameter**
The USET command was expecting a decimal parameter and either received none or received an alpha character.
- 152 **USET character set n parameter error**
A USET character set selection parameter value between 1 and 8 was expected. Error was caused possibly by an invalid numeric value or an alpha character.
- 153 **USET substituted character illegal - must be 1 of 16**
During character substitution in the USET command, the hex value for the character being replaced must be one of the specified 16 hex values. Only the following hex values (*ca*) can be replaced by another hex value (*fa*): 21, 22, 23, 24, 25, 26, 40, 5B, 5C, 5D, 5E, 60, 7B, 7C, 7D, 7E.
- 154 **USET defined character illegal - must be hex 20-FF**
During the USET command, the hex value for the substituted character (*fa*) must range between hex 20 and hex FF. The value given may be out of bounds.
- 155 **USET syntax error - END command is expected**
An END command is expected when the USET character set definition is completed.
- 156 **No such CONFIGURATION option**
- 157 **Left or Top/Bottom margin too large for the current page size**
- 158 **Invalid CONFIG parameter error - out of range**
- 159 **Download Data into Memory Module Failed**
- 160 **FONT command, FONTLOAD command, or DELETE FONT command parameter error**
- 161 **Illegal FONT typeface value - must be resident**
- 162 **Illegal FONT bolding factor - must be ON(1) or OFF(0)**
- 163 **Illegal FONT slant - must be LEFT(-1), OFF(0) or RIGHT(1)**
- 164 **Illegal FONT point size - must be 4 - 999**
- 165 **Illegal FONT symbol set value**
- 166 **Illegal FONT space value - must be 0, 1, 2, or 3**
- 167 **Illegal FONT Block setting - must be 0, 1, 2, or 3**
- 168–169 Not defined
- 170 **PAPER/CASSETTE command syntax error**
- 171 **Invalid PAPER parameter error - out of range**
- 172 **Illegal FONT name format, too long or not found**
- 173 **Insufficient memory for font download**
- 174 **Parameter out of bounds**
- 175–179 Not defined
- 180 **Australian 4-state barcode invalid FCC (2 digits)**

- 181 **Australian 4-state barcode invalid Sorting number (8 digits)**
- 182 **Australian 4-state barcode invalid Customer Data**
- 183 **Aztec barcode invalid parameters or data**
- 184 **RSS barcode composite data or parameters are invalid**

Font Errors

- 160 **FONT command or FONTLOAD parameter error**
The FACE # parameter or FONTLOAD command is either missing a space between the parameter and its value, or a semicolon is missing between font parameters.
- 161 **Illegal FONT typeface value - must be resident**
An illegal FONT typeface value was used. FONT typeface values range from 90000 through 99999, or 0 through 9999.
- 162 **Illegal FONT bolding factor - must be ON(1) or OFF(0)**
An illegal FONT bolding value was used. ON (or 1) or OFF (or 0) must be entered.
- 163 **Illegal FONT slant - must be LEFT (-1), OFF (0) or RIGHT (1)**
An illegal FONT slant value was used. LEFT (or -1), OFF (or 0), or RIGHT (or 1) must be entered.
- 164 **Illegal FONT point size - must be 4-999**
An illegal FONT point size was used. Valid values range from 4 through 999.
- 165 **Illegal FONT symbol set value**
An invalid SYMSET parameter value was used. Valid parameter values are 0 through 31 and 1100 to 1103.
- 166 **Illegal FONT space value - must be 0, 1, 2 or 3**
An illegal FONT space value was used. Only 0, 1, 2 or 3 constitute valid values.
- 167 **Illegal FONT Block setting - must be 0, 1, 2, or 3**
- 168-169 Not defined.
- 170 **PAPER/CASSETTE command syntax error**
- 171 **Invalid PAPER parameter error - out of range or not supported**
- 172 **Illegal FONT name format, too long or not found**
- 173 **Insufficient memory for font download**
- 174 **Parameter out of bounds**
- 175-179 Not defined.

Bar Code Errors

180	Australian 4-state barcode invalid FCC (2 digits)
181	Australian 4-state barcode invalid Sorting number (8 digits)
182	Australian 4-state barcode invalid Customer Data
183	Aztec barcode invalid parameters or data
184	RSS barcode composite data or parameters are invalid
185	Not defined
186	Not defined
187	Not defined
188	Not defined
189	Not defined

Miscellaneous Errors

200	Logo Length is longer than form length
201	Dynamic data field DF _n not previously defined
204	Dynamic data field DF _n previously defined
205	CIRCLE format or delimiter error in input parameters
206	ELLIPSE format or delimiter error in input parameters
207	ELLIPSE/CIRCLE starting column SC out of bounds
208	ELLIPSE/CIRCLE ending column EC out of bounds
209	ELLIPSE/CIRCLE starting row SR out of bounds
210	ELLIPSE/CIRCLE ending row ER out of bounds
211	ELLIPSE/CIRCLE border thickness LT error
212	Insufficient memory to store the ELLIPSE
213	Insufficient memory to store the CIRCLE
214	XML data stream element error
215	XML data stream attribute error
216	XML data stream data error
217	XML data stream syntax error
218	DIAGONAL format or delimiter error in input parameters
219	DIAGONAL starting column SC out of bounds
220	DIAGONAL ending column EC out of bounds
221	DIAGONAL starting row SR out of bounds
222	DIAGONAL ending row ER out of bounds
223	DIAGONAL border thickness LT error
224	Insufficient memory to store the DIAGONAL
225	QRCode: Invalid Barcode Model
226	QRCode: Invalid Error Correction Level

227	QRCode: Invalid Mask Number
228	QRCode: Invalid Data Entry Method
229	QRCode: Invalid Concatenation Mode
230	QRCode: Invalid Partition Number
231	QRCode: Invalid Total Partition Number
232	QRCode: Invalid Parity Data
233	SD card is not installed or insufficient memory
236	The command is not supported.

A *Compatibility Across Models*

Overview

This appendix covers PGL command compatibility across different models. All PGL commands and their parameters are processed regardless of model. However, some models have different features than others. When a feature is not supported, the command will be absorbed without any action. This appendix will clarify commands that are processed versus those that are ignored.

Certain commands such as CONFIG (see page 45) and PAPER (see page 81) have a significant number of different parameters that can be used. Compatibility for these commands is provided in their respective command descriptions.

Checkmarked table cells in this section means full compatibility for all applicable models in the line matrix product line. If the columns are left blank, the command is ignored for the given product line. If individual models are listed, the commands are supported only on those listed models.

Normal Mode Commands

This section covers Normal Mode commands.

Table 48 Normal Mode Commands

Command	Mnemonic	Line Matrix
Cancel	CANCEL	✓
Change SFCC	SFCC	✓
Compressed Print	DENSITY	✓
Configuration	CONFIG	See page 45
Create	CREATE	✓
Create Logo	LOGO	✓
Delete Font	DELETE FONT	✓
Delete Form	DELETE FORM	✓
Delete Logo	DELETE LOGO	✓
Directory	DIRECTORY	✓
Emulation Switch	EMULATION	✓

Table 48 Normal Mode Commands

Command	Mnemonic	Line Matrix
Enquiry	ENQUIRY	✓
Execute	EXECUTE	✓
Expanded Print	EXPAND	✓
Font	FONT	✓
Font Load	FONTLOAD	✓
Hex Sequence On/Off	HEXON HEXOFF	✓
Ignore Sequence On/Off	IGON IGOFF	✓
Line Spacing, Vertical	LPI	✓
Listen	LISTEN	✓
Month Name	MONTH	RTC Only
Multinational Character Set	USET ISET	✓
Normal Mode	NORMAL	✓
Optimize	OPTIMIZE	✓
Paper	PAPER	See page 81
Paper Instruction Enable/Disable	EN-PI DIS-PI	✓
Paper Instruction On/Off for Data Bit 8	PION PIOFF	✓
Print File	PRINT	✓
Printer Identification	IDENTITY	✓
Printer Status	STATUS	✓
Quiet	QUIET	✓
Recall	RECALL	✓
Reset	RESET	✓
Set Clock	SETCLOCK	RTC only
Select Format On/Off	SFON SFOFF	✓
Set Up	SETUP	✓

Create Mode Commands

This section covers Create Mode commands.

Table 49 Create Mode Commands

Command	Mnemonic	Line Matrix
Alphanumerics	ALPHA	✓
Alpha, Incremental	ALPHA	✓
Bar Codes	BARCODE	✓
Boxes	BOX	✓
Circle	CIRCLE	✓
Corners	CORNER	✓
Duplication, Horizontal	HDUP	✓
Duplication, Vertical	VDUP	✓
Ellipse	ELLIPSE	✓
End	END	✓
Font	FONT	✓
Form Length	LFORM	✓
Ignore Sequence On/Off	IGON IGOFF	✓
Lines, Diagonal	DIAG	
Lines, Horizontal	HORZ	✓
Lines, Vertical	VERT	✓
Logo Call	LOGO	✓
Logo Mode, Create	LOGODEF	✓
Multinational Character Set	ISSET	✓
Page Number	PAGE	✓
Printer Mode	PMODE	✓
Reset	RESET	✓
Reverse Print	REVERSE	✓
Scale	SCALE	✓
Scaling	SMODE	✓
Select Format On/Off	SFON SFOFF	✓

Execute Mode Commands

This section covers Execute Mode commands.

Table 50 Execute Mode Commands

Command	Mnemonic	Line Matrix
Compressed Print	DENSITY	✓
Dynamic Alphanumeric Data	AF <i>n</i>	✓
Dynamic Bar Code Data	BF <i>n</i>	✓
Dynamic Logo	GF <i>n</i>	✓
Expanded Print	EXPAND	✓
Font	FONT	✓
Hex Sequence On/Off	HEXON HEXOFF	✓
Ignore Sequence On/Off	IGON IGOFF	✓
Incremental Alphanumeric Dynamic Data	IAF <i>n</i>	✓
Incremental Bar Code Dynamic Data	IBF <i>n</i>	✓
Line Spacing, Vertical	LPI	✓
Multinational Character Set	ISSET	✓
Normal Mode	NORMAL	✓
Paper	PAPER	See page 81
Reset	RESET	✓
Repeat	REPEAT	✓
Select Format On/Off	SFON SFOFF	✓

C *Grid Programs And Samples*

The Standard Grid. The standard grid is used for form design. The program for the standard grid is listed below, and a sample of the standard grid follows on the next page. Photocopy the grid provided or enter the grid program and make your own printout.

```
-CREATE;GRID
HDUP:75:1
VERT
1:1:1:61
STOP
HDUP:OFF
HDUP:7:10
VERT
1:5:1:61.5
2:10:1:61.5
STOP
HDUP:OFF
VERT
2:75:1:61.5
STOP
VDUP:61:1
HORZ
1:1:1:75
STOP
VDUP:OFF
VDUP:6:10
HORZ
1:5:1:76
2:10:1:76
STOP
VDUP:OFF
VERT
2:1:1:61.3
STOP
HORZ
2:1:1:75
STOP
VDUP:12:5
ALPHA
I:5.5:76:0:0:05;" 5"
STOP
VDUP:OFF
HDUP:14:5
ALPHA
C15:I:61.9:5:0:0:05;" 5"
STOP
HDUP:OFF
END

-EXECUTE;GRID:1
```

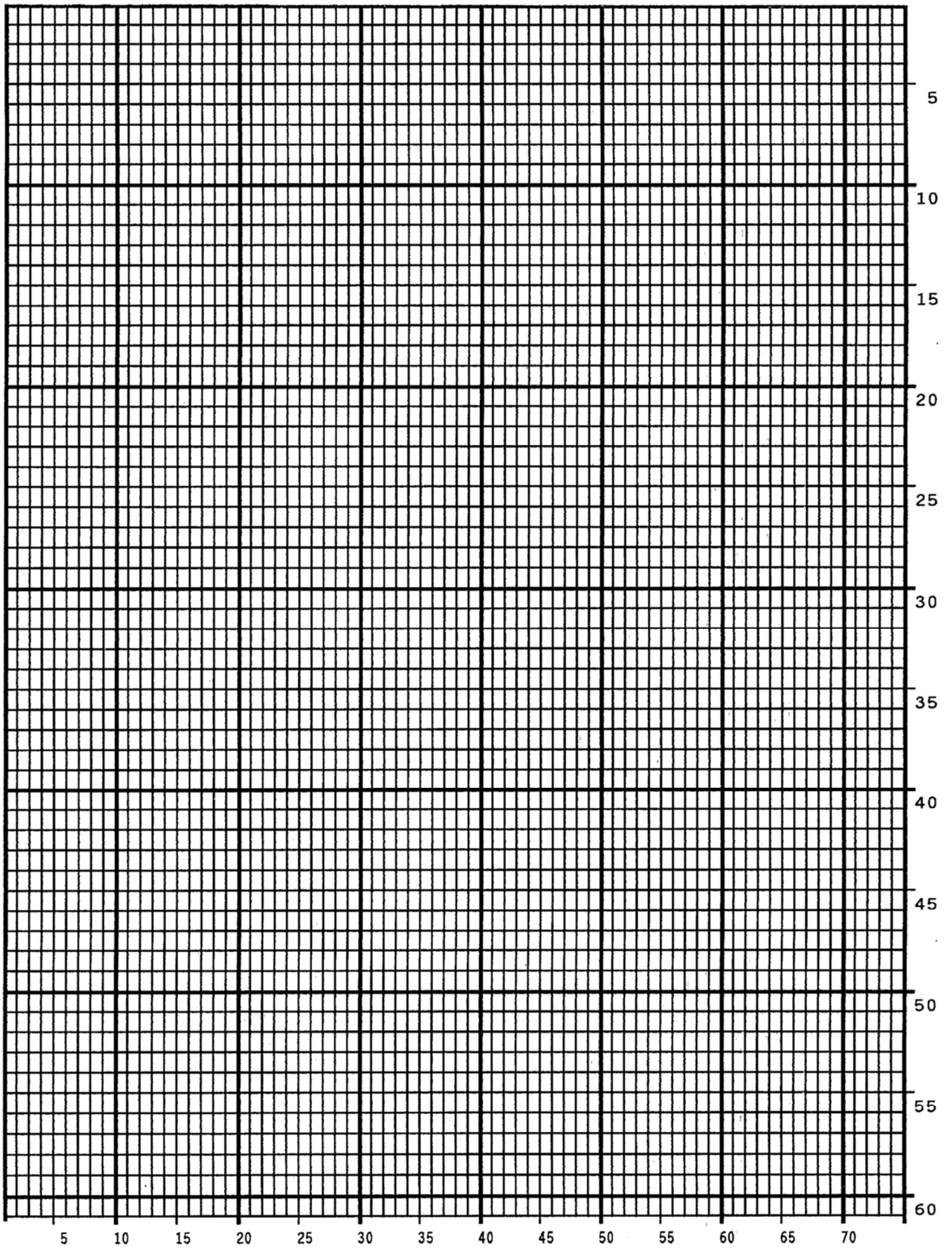

The Logo Grid. The program for a logo grid is listed below and the sample grid follows. It is not the full size logo grid; the grid can measure up to 240 columns wide by 252 rows high for a logo 4 x 3.5 inches. Photocopy the grid or enter the grid program to obtain a printout.

```
-CREATE; LOGOGRID  
HDUP; 75; 1  
VERT  
1; 4; 4; 56  
STOP  
HDUP; OFF  
HDUP; 5; 15  
ALPHA  
C17; I; 3; 8.2; 0; 0; 15; "05"  
C17; I; 3; 13.2; 0; 0; 15; "10"  
I; 3; 18.2; 0; 0; 15; "15"  
STOP  
VERT  
2; 18; 3.5; 56  
1; 8; 3.9; 56  
1; 13; 3.9; 56  
STOP  
HDUP; OFF  
VDUP; 105; 0.6  
HORZ  
1; 4; 4; 78  
STOP  
VDUP; OFF  
VDUP; 7; 7.6  
ALPHA  
C17; I; 5.11; 79; 0; 0; 015; " 5"  
C17; I; 8.6; 79; 0; 0; 015; " 10"  
C13; I; 11.5; 78.2; 0; 0; 015; "15"  
STOP  
HORZ  
2; 10.11; 4; 79.5  
1; 6; 4; 79  
1; 8.6; 4; 79  
STOP  
VDUP; OFF  
END  
-EXECUTE; LOGOGRID; 1
```

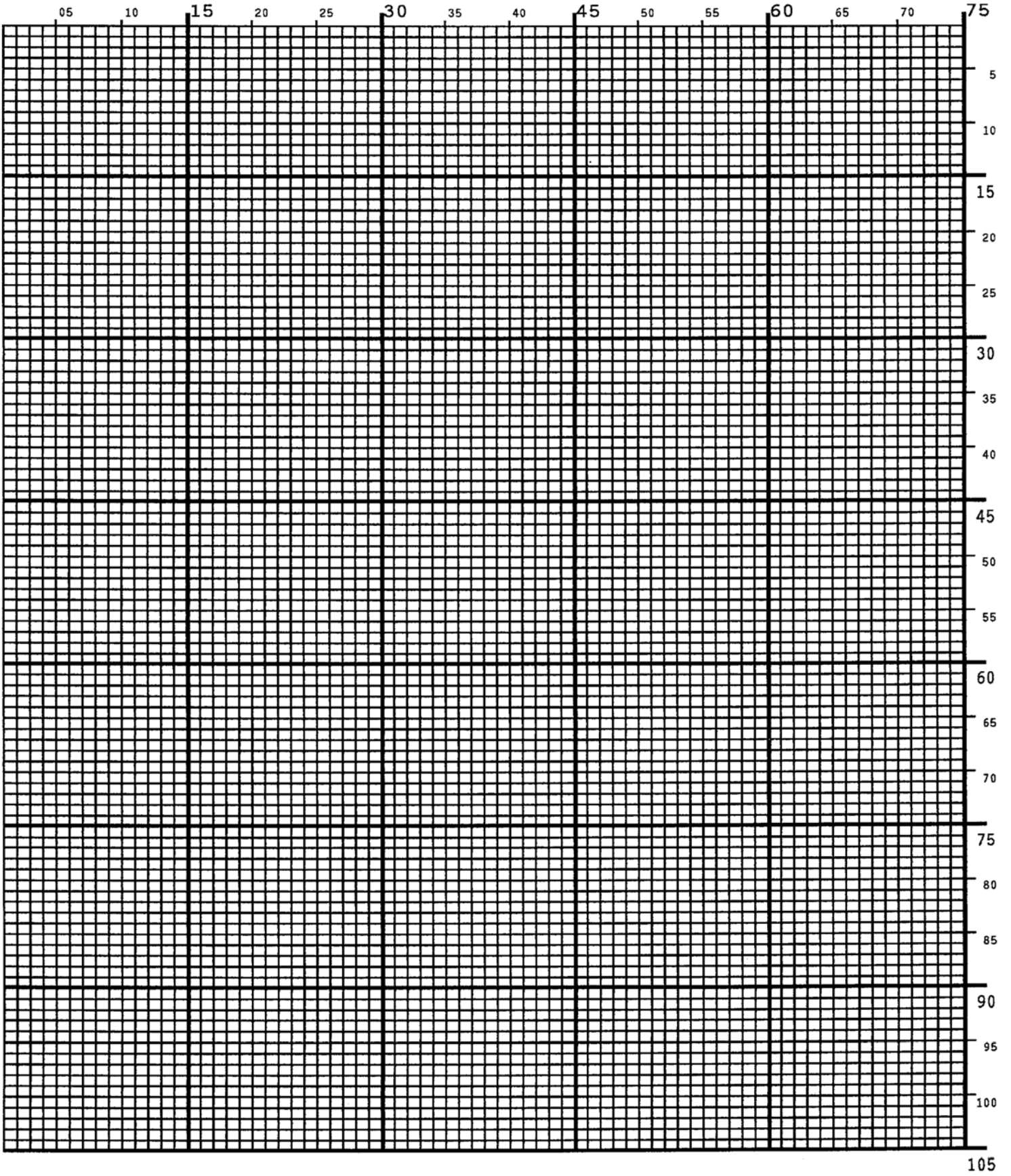

D *Page Boundaries*

Paper Selection and Maximum Values

Most Create Form mode commands require you to identify specific form boundaries using the *SR*, *SC*, *ER*, *EC* parameters. This appendix addresses the page boundaries affecting IGP/PGL products for both cut-sheet page printers and continuous form printers.

All printers have maximum print boundaries according to the printer type and paper size selected. Refer to your printer *Administrator's Manual* for the specific page boundaries associated with your printer. Table 51 shows the print boundaries for page printers using several different widths and lengths.

Note that while both cut-sheet page printers and continuous form printers have specific maximum *width* values based on paper size, continuous form printers are not bound by the same maximum page *length* values; on a continuous form printer, if you specify a page length exceeding the actual paper size, the form will continue to print until it is completed.

The maximum dot values such as those shown in Table 51 are necessary to determine the maximum printable area on your form for your printer when modifying top/bottom margin settings or offsetting the values for left margin print positions. The following pages explain how to determine the Top/Bottom Margin and Left Margin requirements for your printer.

Create Form Mode

In the Create Form mode, both the form's length and width used for boundary checking may be specified by the user. However, if the form size is not specified, the form length defaults to 11" and the width is not checked. Boundary checking for form elements is performed only when the form length is specified.

Execute Form Mode

In the Execute Form mode, use the following guidelines to determine if a form will print on the current page size.

Not User-Defined

If the form's length/width is not user-defined, and the minimum length/width is *greater* than the current page length/ width, minus the margins, then the result will be error 74 or 75.

User-defined

If the form's length/width is user-defined *greater* than the current page length/ width, minus the margins, then the result will be error 74 or 75.

Not-defined

If the form's length/width is not-defined and the minimum length/width is *less than or equal to* the current page length/width, minus the margins, then the form length/width will equal the page length/width, minus the margins.

Table 51 Paper Sizes and Maximum Print Area

Paper Size	Dimensions (inches)	Maximum Dot Value*	
		Page Width	Page Length
Letter	8.0 x 11	481	793
Letter	8.5 x 11	511	793
Legal	8.5 x 14	511	1009
A4	8.268 x 11.693	497	842
B5	6.929 x 9.842	416	709
AIAG Label	4 x 6	241	433
Odette Label	8 x 5	481	361

*How to calculate Maximum Dot Values:
 1. Page Length x 72 dpi minus Top and Bottom Margin Values + 1 = maximum height value;
 2. Page Width x 60 dpi minus Left Margin Value + 1 = maximum width value.
 Values exceeding maximum values will produce an error message.

Setting Top/Bottom Margins

Using dot values to identify maximum vertical print positions, the page boundary parameter of an 11-inch form has 792 dot rows at $n/72$ -inch vertical resolution (72 dpi X 11 inches). (See Figure 72).

With no Top/Bottom Margin configuration setting on an 11-inch form, the first print position is Starting Row 1, Starting Column 1 (A). However, if a Top/ Bottom Margin value is set at 10, then Starting Row 1 is adjusted *down* by 10 dot rows (B), and the Ending Row is adjusted *up* 10 dot rows (C), thereby reducing the maximum vertical printable area to 773 dots (793 - [10 + 10]). The greater the top/bottom margin setting, the smaller the printable area on the form.

NOTE: The Top/Bottom margins are set under the LinePrinter+ configuration menu (if present), or from the host by sending the PGL CONFIG command. See the Commands chapter.

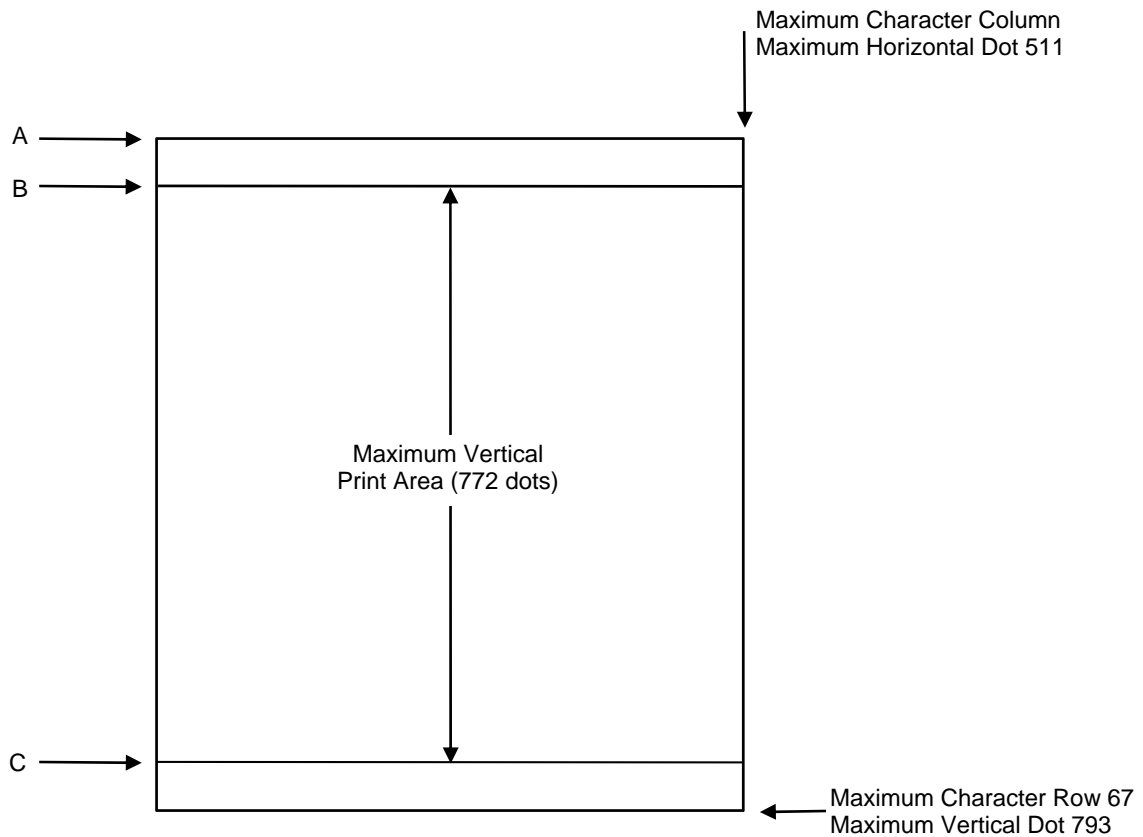

Figure 72 Top/Bottom Margin Example

Setting Left Margins

Using dot values to identify maximum horizontal print positions, the page boundary parameter of an 8-1/2-inch wide form (85 character columns) has 510 dot columns (1-511) + $n/60$ -inch horizontal resolution (60 dpi X 8.5 inches). (See Figure 72). Setting a Left Margin value repositions the Starting Column 1 position by the degree of offset required. This offset can be a 0, a positive, or negative value. The following examples explain how setting the Left Margin affects printed output:

No Left Margin Setting. When the Left Margin configuration setting is 0 on an 8-1/2-inch form, the Starting Column is 1, and the Ending Column is 511 (, A and B, respectively).

Positive Left Margin Setting. When the Left Margin setting is 20 on an 8-1/2-inch form, the left margin is offset by 20 dots, and that 20th dot position becomes Starting Column 1 in IGP/PGL memory (A, Figure 74). This 20 dots also offsets the Ending Column by 20 dots, thus narrowing the maximum print width on the form from 511 to 491 dots (B, Figure 74).

Negative Left Margin Setting. With a Left Margin setting of -20 on an 8-1/2-inch form, the left margin is offset -20 dots, and that -20 becomes the Starting Column 1 in IGP/PGL memory (A, Figure 75). This -20 offset appears to expand the horizontal printable area to 531 dots (B, Figure 75); however, the expanded area is actually beyond the addressable range of the 8-1/2-inch-wide form containing the -20 offset position and is, therefore, not accessible. Column 21 is the left-most addressable area on the page.

NOTE: Negative Left Margin configuration is a method of offsetting and printing an existing IGP/PGL file which may otherwise require modification in order to orient the output on the page properly. Use this option if your IGP/PGL file was written for applications where the leftmost printable area is not designated as the first printable character column on the form.

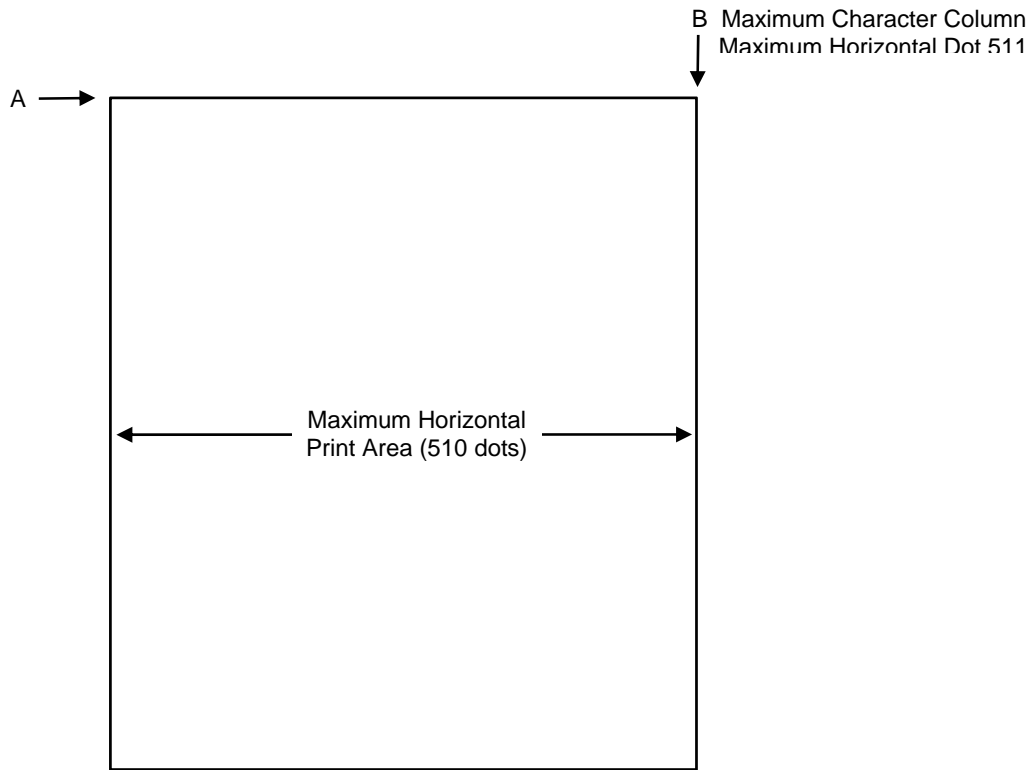

Figure 73 Left Margin Example - No Setting

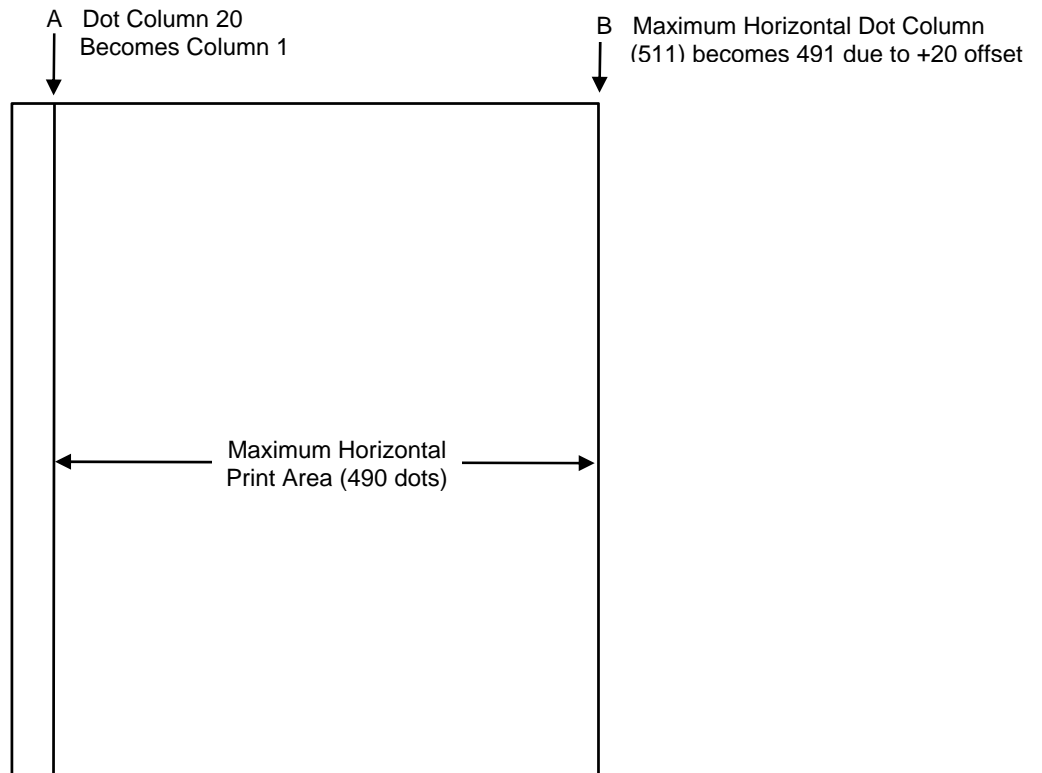

Figure 74 Left Margin + 20 Setting Example

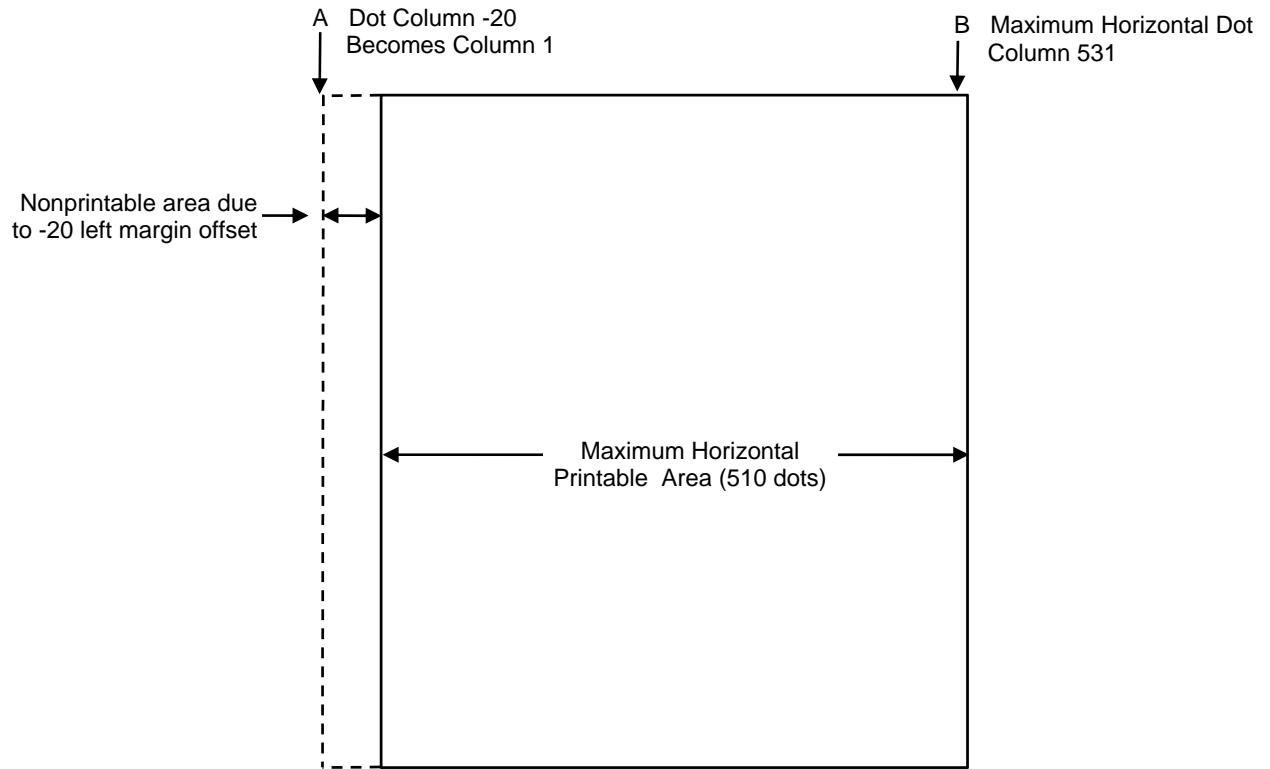

Figure 75 Left Margin -20 Setting Example

E *Vertical Paper Motion*

Introduction

There are three methods of advancing the print position with the IGP/PGL which are explained in this appendix:

1. Using line feeds or form feeds;
2. Using the paper instruction (PI) line; or
3. Using the Electronic Vertical Format Unit (EVFU).

In impact printers, print position is adjusted by vertical paper motion down the page. Because no paper motion occurs during forms creation in non-impact printers, advancing the print position refers to cursor movement down the page according to positioning commands received by the host. Throughout this appendix, the term advancing the print position will be used to generically refer to this concept of cursor movement/vertical paper motion.

Paper Motion Using Line Feeds and Form Feeds

The most common method of advancing the print position with IGP/PGL is through the use of line feeds and form feeds. A line feed moves the print position down a distance determined by the current line spacing (lpi). In the Normal mode, a form feed character advances the print position to the top of the next page; in the Execute mode, a form feed advances the print position to the top of the next form. Form length is determined by the CREATE command.

Paper Motion using the PI Line (Relative Line Slewing)

The method of moving the print position using the PI line results in vertical slews of a specified number of lines relative to the current print position (rather than slewing to a specific line). For this to occur, the following criteria must be met:

1. The PI line must be enabled and set high; and
2. Data bit 5 must be 1 (set).

When a number of blank lines will be skipped on a form, (called "paper slewing") another method of paper motion may be used. The PI signal can be detected by the IGP/PGL as the 8th data bit in a serial interface, or a separate input line in a parallel interface. (Refer to the EN-PI/DIS-PI command on page 83 and the PION/PIOFF command on page 82 in the Commands chapter). When the PI signal is used, bits 6 and 7 are interpreted as 0 values, and characters hex 10 through 1F are interpreted as binary slew commands.

The binary slew commands can skip from 1 through 15 or 1 through 16 lines on the form, depending on how the Slew Range configuration option is configured. Refer to Table 52 which illustrates how lines are skipped for each value. (Note that the state of data bit 5 is the difference between line slewing and using the interface lines as EVFU channel codes.) This type of vertical paper motion occurs whenever the line slewing command is used regardless of whether the EVFU memory is loaded or not.

Table 52 Line Slewing

ASCII			8*	Data Bits							Slew Range Configuration	
Hex	Dec	Code		7	6	5	4	3	2	1	0	1
10	16	DLE	1	X	X	1	0	0	0	0	1	1
11	17	DC1	1	X	X	1	0	0	0	1	2	1
12	18	DC2	1	X	X	1	0	0	1	0	3	2
13	19	DC3	1	X	X	1	0	0	1	1	4	3
14	20	DC4	1	X	X	1	0	1	0	0	5	4
15	21	NAK	1	X	X	1	0	1	0	1	6	5
16	22	SYN	1	X	X	1	0	1	1	0	7	6
17	23	ETB	1	X	X	1	0	1	1	1	8	7
18	24	CAN	1	X	X	1	1	0	0	0	9	8
19	25	EM	1	X	X	1	1	0	0	1	10	9
1A	26	SUB	1	X	X	1	1	0	1	0	11	10
1B	27	ESC	1	X	X	1	1	1	1	1	12	11
1C	28	FS	1	X	X	1	1	1	0	0	13	12
1D	29	GS	1	X	X	1	1	1	0	1	14	13
1E	30	RS	1	0	0	1	1	1	1	0	15	14
1F	31	US	1	0	0	1	1	1	1	1	16	15
X = Undefined, 0 or 1				1 = High				0 = Low				

NOTE: *The ASCII values in Table 52 assume that all undefined bits are set to 0. When the PI line is enabled, data bit 8 is the PI line on a serial interface, and data bit 8 is undefined on a parallel interface.

Paper Motion using the EVFU

The Electronic Vertical Format Unit (EVFU) is an efficient method of skipping to a specified print position during repetitive printing tasks. The EVFU affects the vertical placement of overlay data produced in the Execute Form mode.

General EVFU Programming

The general EVFU programming procedure is as follows:

1. Design a form, determining spacing and channel assignments for each line.
2. Send the programming sequence to the printer.

The following information applies when programming and using the EVFU:

PI Line. The PI signal can be detected by the IGP/PGL as the 8th data bit in a serial interface, or a separate input line in a parallel interface. (Refer to the EN-PI/DIS-PI command on page 83 and the PION/PIOFF command on page 82 in the Commands chapter).

Elongated Characters. Elongated (double high) characters can be used within EVFU programs. The EVFU automatically counts one line of elongated characters as two normal character lines.

Paper Runaway Protection. If the EVFU is selected but not loaded when an EVFU command is sent from the host computer, the printer moves the paper a single line feed. If the EVFU is selected and the memory is loaded, a channel code sent from the host, which is not a part of the assigned sequence currently in memory, moves the paper a single line feed.

Line Spacing. The printer can use any line spacing with the EVFU. The EVFU determines the forms length according to the program specifications and the currently selected line spacing. For example, 14-inch paper with 10 lpi line spacing would yield a 140-line form which can be defined by the EVFU. Mixing line spacing on the same form unloads the EVFU.

EVFU Programming Sequence

The EVFU provides 16 channels to identify up to 192 lines. An error results if the EVFU form length exceeds the physical length of the page, and the IGP/ PGL returns to the Normal mode. The number of channels in an EVFU overrides the length of the form as it was defined in the CREATE mode; therefore, the EVFU must be equal to or longer than the form being used.

The EVFU programming sequence is listed below and explained in the following sections.

1. Start load code;
2. Line identification codes; and
3. End load code.

Start Load Code - Hex 1E or 6E

The Start Load code clears and initializes the EVFU memory for channel assignment storage. Refer to Table 53 or Table 54 on page 346 and page 347, respectively, for the appropriate start load code.

Channel Assignment

The EVFU memory has the capacity for 192-line forms. The first line identification code (channel code) in the EVFU load data defines the first line on the form; the second line identification code defines the second line on the form, etc. Each line must have a line identification code.

A single channel code is used repeatedly throughout a form to reserve blank lines between defined channel codes and to maintain the correct forms length. These “filler” channels can be any channel number except channel code 1 (which is reserved for the top-of-form) and channel code 12 (which is reserved as the vertical tab channel). In the EVFU example which begins on page 347, filler channels are represented by a hex 11 code. Calls are rarely made to filler channels because they do not specify a unique print position on the form.

Channel 1. The top-of-form code, reserved as the first line on the form. The operating program sends the channel 1 code to advance to the top of the next form. After the memory is loaded, a Form Feed code (FF, hex 0C) moves the paper to the next channel 1 (top-of-form).

Channels 2 through 11, 13 and 14. Used as general channel codes (also referred to as line identification codes) or as filler channels. Each line on the form must be identified by a channel code. When the operating program sends the channel code, the print position moves to the line identified by the channel code.

Channel 12. Reserved as the vertical tab channel. The vertical tab code (VT, hex 0B) rapidly advances the print position to the next line identified by the channel 12 code. If channel 12 is not loaded in the EVFU memory, a single line feed is executed when a VT code is sent.

End Load - Hex 1F or 6F

The end load code terminates the channel storage and saves the EVFU in memory. Refer to Table 53 or Table 54 on page 346 and page 347, respectively, for the appropriate end load code. Channel codes in excess of 92 channels received prior to the end load code cause an error.

Using the EVFU

Sending the appropriate EVFU channel code to the printer causes any data in the buffer to print and move the print position to the next line on the form having the specified channel number assigned in EVFU memory.

To recognize a data byte as an EVFU instruction, one of the following sets of criteria must be met:

1. The PI line must be enabled and set high;
2. Bits 7 and 6 can be set to 1 or 0; and
3. Data bit 5 must be 0 (not set).

OR:

1. The PI line must be disabled or low;
2. Bits 7 and 6 must be 0 (not set); and
3. Data bit 5 must be 1 (set).

Given these conditions, the lower four bits of a byte specify the EVFU channel number. Table 53 lists the EVFU channels and their equivalent data bytes when the PI line is enabled; Table 54 lists the EVFU channel and their equivalent data bytes when the PI line is disabled.

Table 53 EVFU Codes - PI Line Enabled

ASCII			Data Bits								Channel
Hex	Dec	Code	8*	7	6	5	4	3	2	1	
00	0	NUL	1	X	X	0	0	0	0	0	1 (TOF)
01	1	SOH	1	X	X	0	0	0	0	1	2
02	2	STX	1	X	X	0	0	0	1	0	3
03	3	ETX	1	X	X	0	0	0	1	1	4
04	4	EOT	1	X	X	0	0	1	0	0	5
05	5	ENQ	1	X	X	0	0	1	0	1	6
06	6	ACK	1	X	X	0	0	1	1	0	7
07	7	BEL	1	X	X	0	0	1	1	1	8
08	8	BS	1	X	X	0	1	0	0	0	9
09	9	HT	1	X	X	0	1	0	0	1	10
0A	10	LF	1	X	X	0	1	0	1	0	11
0B	11	VT	1	X	X	0	1	0	1	1	12 (VT)
0C	12	FF	1	X	X	0	1	1	0	0	13
0D	13	CR	1	X	X	0	1	1	0	1	14
6E	110	n	1	1	1	0	1	1	1	0	Start Load
6F	111	o	1	1	1	0	1	1	1	1	End Load
X = Undefined, 0 or 1			1 = High				0 = Low				

NOTE: *The ASCII values in Table 53 assume that all undefined bits are set to 0. When the PI line is enabled, data bit 8 is the PI line on a serial interface, and data bit 8 is undefined on a parallel interface.

Table 54 EVFU Codes - PI Line Disabled or Not Used

ASCII			Data Bits							Channel	
Hex	Dec	Code	8	7	6	5	4	3	2	1	
10	16	DLE	0	0	0	1	0	0	0	0	1 (TOF)
11	17	DC1	0	0	0	1	0	0	0	1	2
12	18	DC2	0	0	0	1	0	0	1	0	3
13	19	DC3	0	0	0	1	0	0	1	1	4
14	20	DC4	0	0	0	1	0	1	0	0	5
15	21	NAK	0	0	0	1	0	1	0	1	6
16	22	SYN	0	0	0	1	0	1	1	0	7
17	23	ETB	0	0	0	1	0	1	1	1	8
18	24	CAN	0	0	0	1	1	0	0	0	9
19	25	EM	0	0	0	1	1	0	0	1	10
1A	26	SUB	0	0	0	1	1	0	1	0	11
1B	27	ESC	0	0	0	1	1	0	1	1	12 (VT)
1C	28	FS	0	0	0	1	1	1	0	0	13
1D	29	GS	0	0	0	1	1	1	0	1	14
1E	30	RS	0	0	0	1	1	1	1	0	Start Load
1F	31	US	0	0	0	1	1	1	1	1	End Load
X = Undefined, 0 or 1			1 = High							0 = Low	

NOTE: Do not use your SFCC as a channel code when using the EVFU.

Clearing the EVFU Memory

The following actions reset (clear) the EVFU memory:

1. Sending only the start load code.
2. Sending a start load code followed immediately by an end load code.
3. A second start load code is received, resulting in re-initialization of the EVFU. (This restarts the EVFU load sequence.)

When the EVFU memory is cleared, the forms length returns to the previously set value.

EVFU Example

The following EVFU example is a 2-inch form at 6 lpi line spacing. Thus, 12 lines on the form must be defined. The form is repeated 3 times. Paper instructions are disabled.

Assign Line Identification Codes

Line ID Code	Description	Assigned Hex Code
Start Load	Start EVFU	1E
Line 1	Top of Form	10
Line 2	Filler	11
Line 3	Filler	11
Line 4	Filler	11
Line 5	Vertical Tab	1B
Line 6	First channel stop	13
Line 7	Filler	11
Line 8	Filler	11
Line 9	Second channel stop	12
Line 10	Filler	11
Line 11	Third channel stop	15
Line 12	Filler	11
Stop Load	End EVFU	1F

EVFU Format in Execute Mode

The Execute command shown on page 348, derived from the Execute command format on page 58, illustrates how the EVFU data above is incorporated into the Execute command. All other Execute command parameters are shown in *italics*. (Optional parameters are shown in brackets [].) Figure 76 illustrates the printed output from this data.

The boldface line below the EXECUTE command represents the hexadecimal EVFU load sequence which identifies the channel codes at which overlay data will be placed on each form. The example hex values correspond to the line identification codes listed above. Channel codes not described above as Filler channels are assigned unique hex codes. Calls to these channels will print overlay data at specific positions on the form.

The two *~AF* lines, also shown in *italics*, represent the dynamic data. While the EVFU does not affect dynamic data positioning (data placement is defined by the ALPHA statement when the form was created), the commands are shown to specify where they would occur in relation to the EXECUTE command, the EVFU load sequence, and the overlay data.

The four lines of EVFU overlay data (shown in **boldface** type) follow the two lines of dynamic data. This overlay data is positioned on the form according to the specified channel codes called. The superscript hexadecimal numbers enclosed in < > symbols represent calls to the four unique EVFU channel codes.

```
(cc)EXECUTE; formname [;PAGE n] [;FC] [;ICNTn] [;IRSTn] [;DISK]
1E 10 11 11 11 1B 13 11 11 12 11 15 11 1F
~AF1;*DYNAMIC DATA #1*
~AF2;*DYNAMIC DATA #2*
<13>DATA FOR LINE 6<17>
<10><12>DATA FOR LINE 9
<1B>DATA FOR VERTICAL TAB CHANNEL
<15>DATA FOR LINE 11
[Form Feed character]
```

(cc)NORMAL

When the IGP/PGL receives a channel call, it searches for that channel from the current print position in the EVFU load sequence to the end of the EVFU load sequence. If that channel is found, the current print position becomes that channel on the same form. If the channel is not found, the search continues from the beginning of the EVFU load sequence to the current print position. If this search is successful, the current form is printed, the next form is called, and the current print position becomes the channel position in the EVFU. If the channel called is not found in either search, the channel call is treated as if it were a line feed.

	EVFU Channel Code Sent	Line No.	Form Output
	1E	Start Load	
Form #1	10	1 (TOF)	<i>(top of form, Form #1)</i>
	11	2	
	11	3	
	11	4	
	1B	5	
	13	6	DATA FOR LINE 6
	17	7	<i>(undefined hex 17 causes single line feed)</i>
	11	8	
	12	9	
	11	10	
	15	11	
	11	12	
Form #2	10	1 (TOF)	<i>(top of form, Form #2)</i>
	11	2	
	11	3	
	11	4	
	1B	5	
	13	6	
	11	7	
	11	8	
	12	9	DATA FOR LINE 9
	11	10	
	15	11	
	11	12	
Form #3	10	1 (TOF)	<i>(top of form, Form #3)</i>
	11	2	
	11	3	
	11	4	
	1B	5	DATA FOR VERTICAL TAB CHANNEL
	13	6	
	11	7	
	11	8	
	12	9	
	11	10	
	15	11	DATA FOR LINE 11
	11	12	
	1F	End Load	

Figure 76 Sample EVFU Form

F *Typefaces*

This appendix illustrates standard typefaces available with IGP/PGL.

Standard Typefaces

The standard fonts available depends on the printer. Beside each typeface is the 5-digit value required in the FACE # parameter of the FONT command (see page 66).

Line Matrix

Table 55 Standard Fonts for Line Matrix Printers

Font Name	Font Face Number
Letter Gothic Bold	93779

G *PGL-DBCS*

This appendix describes the additional and unique commands for Printronix Line Matrix Printers:

- Line Matrix printers include three firmware options with the DBCS fonts embedded: PGL-Hangul KS, PGL-Hanzi GB, PGL-Kanji Shift-JIS emulation software.

PGL-DBCS is an extension to existing PGL (ASCII) that supports Korean KSC, Chinese Hanzi GB, and Japanese Shift-JIS character printing respectively. The differences among those printers are as follows:

- PGL-Hangul KS supports KSC code table for Korean character code points used only in South Korea.
- PGL-Hanzi GB supports GB code table for simplified Hanzi character code points used in People's Republic of China. It also supports GB18030 encoding, but the resident font is GB2312 character set.
- PGL-Kanji Shift-JIS supports Shift-JIS code table for Kanji character code points used in Japan.

The above differences only affect the DBCS code points but the command syntax and the behavior are similar.

TWOBYTE Command Syntax

Create Form : TWOBYTE Command

Purpose Defines and positions DBCS data on a "pre-printed" static field or as a dynamic data field.

TWOBYTE [R [D];] [E;] [Fn;] [Pn;] [kFn;L]; [DIR;] SR; SC; VE; HE;(D)DBCS
DATA(D)
STOP

TWOBYTE The DBCS characters command; enter **TWOBYTE**.

R The optional reverse printing (white on black) parameter. Enter **R** to specify a black background.

E The optional elongated character parameter. Enter **E** to specify elongated character printing. Elongated characters are double height and single width. If used, the **VE** and **HE** parameters must be set to 0, or an error message will result. Elongated character printing is also available with rotated DBCS characters.

Fn : The optional font size parameter, use the following select font size (default F16):

F16 selects 16x16 matrix font cells (physics size is 8).

F24 selects 24x24 matrix font cells (physics size is 12).

Pn : Optional parameter for pitch between characters. If n is not specified, one default n is automatically assigned based on the actual horizontal expansion factor. When option "Compatbl Mode" is set to None, $n=12*HE$. When option "Compatbl Mode" is not set to None, $n=12*(HE-1)*2$.

- KFn:L** The optional dynamic DBCS data field parameter for identifying the DBCS string's dynamic number assignment and designating the number of DBCS characters allowed. If these parameters are used, the actual text cannot be entered during the Create Form mode; it must be entered dynamically during the Execute Form mode. Dynamically entering data during the Execute mode permits changes to the DBCS text without redefining or recreating the form. To use this field, perform the following steps:
- a. Enter **KF**.
 - b. Replace **n** with a number ranging from 1 through 512 to identify DBCS string location on the form. The **SR** and **SC** parameters are used to specify the exact location of the DBCS data field identified by **n**. Since the **TWOBYTE** command and the **ALPHA** command share the same set of identification numbers, therefore do not set the same number for the two commands in one form.
 - c. Set the length of the dynamic DBCS characters in **L** ranging from 1 to 127. The actual number of DBCS characters supplied in the **EXECUTE** mode must be the same or less than this value. In UTF8 mode **L** should be the same or more than the number of bytes supplied in **EXECUTE** mode.
 - d. The DBCS data is not allowed to enter, it can only be supplied in the **EXECUTE** mode.
- DIR** Optional parameter for rotating a DBCS character string. Use the following codes to indicate the direction of character rotation:
- CW** 90 degree clockwise rotation.
- CCW** 90 degree counter clockwise rotation.
- INV** Inverted characters (180 degree rotation)
- SR** Defines the starting row of the DBCS character data field.
- $1 \leq \mathbf{SR} < \text{Form Length}$
- SC** Defines the starting column of the DBCS character data field.
- $1 \leq \mathbf{SC} < \text{Form Width}$
- VE** Defines the vertical expansion factor to enlarge DBCS characters vertically. The factor must ensure that the characters after expansion do not exceed the form boundary limit. The largest value is 63. 0 and 1 specifies the stand font (no expansion), Elongated (E) characters cannot be used with a vertical expansion factor other than 0.
- HE** Defines the horizontal expansion factor to enlarge DBCS characters horizontally. The factor must ensure that the characters after expansion do not exceed the form boundary limit. The largest value is 63. 0 and 1 specifies the stand font (no expansion), Elongated (E) characters cannot be used with a horizontal expansion factor other than 0.
- (D)** The printable character identifying the start and finish of the alphanumeric string. Enter any printable character other than a slash (/), the SFCC, or a character used within the alphanumeric string itself. You must use the same character at both ends of the alphanumeric string, but it will not print with the data.

DBCS/SBCS TEXT

The group of DBCS/SBCS characters (the alphanumeric string) to print. Enter any of the standard DBCS/SBCS printable characters (except the character used to delimit the string in the (D) parameter). The data appears as “pre-positioned” information on the form beginning at the location specified by SR and SC. This is the “fixed” or static DBCS/SBCS data; once defined on the form, it is changed only by redefining the form using the **TWOBYTE** command.

STOP Indicates the end of the **TWOBYTE** command.

EXECUTE Mode Command Syntax (Common)

EXECUTE Form: General Format

Purpose Prints forms created in the CREATE mode.
Mode NORMAL
Format (cc)**EXECUTE**; *formname* [;**PAGE** n] [; **FC**] [;**ICNT** n] [;**IRST** n] [;**DISK**] [**EVFU** Data] [(cc)**AF** n; (**D**)ASCII text(**D**)] [(cc)**KF** n; (**D**)DBCS/SBCS text(**D**)] [(cc)**BF** n; (**D**)data(**D**)] [(cc)**GF** n; (**D**)logoname(**D**)] [(cc)**IAF** n; [idir] STEPMASK;[**RPT** n;] [**RST** n;] (**D**)STARTDATA(**D**)] [(cc)**IBF** n; [idir] STEPMASK;[**RPT** n;] [**RST** n;] (**D**)STARTDATA(**D**)] [Overlay Data] [Form Feed character] (cc)**NORMAL**

NOTE: This document only describes the command syntax usage for (cc)KF_n. Refer to this manual for other command parameters.

(cc)KF_n

Purpose Incorporates the dynamic DBCS data into a previously identified location of a form.

Mode EXECUTE

Format [(cc)**KF** n; (**D**)DBCS/SBCS text(**D**)]

(cc)

KF_n Indicates a dynamic DBCS data field (KF) and its identification number n which was defined with the **TWOBYTE** command in the Create form mode.

(**D**) The separation symbol for identifying the starting and ending of DBCS data. The requirement for this parameter is the same as that for D in the ALPHA command.

DBCS DATA The group of DBCS characters to be printed. The DBCS string appears as the pre-positioned information on the form beginning at the location identified n.

H *Contact Information*

Printronix Customer Support Center

IMPORTANT Please have the following information available prior to calling the Printronix Customer Support Center:

- Model number
- Serial number (located on the back of the printer)
- Installed options (i.e., interface and host type if applicable to the problem)
- Configuration printout: (See "Printing A Configuration") in your printers Administrator's manual.
- Is the problem with a new install or an existing printer?
- Description of the problem (be specific)
- Good and bad samples that clearly show the problem (faxing or emailing of these samples may be required)

Americas	(714) 368-2686
Europe, Middle East, and Africa	(31) 24 6489 311
Asia Pacific	(65) 6548 4114
China	(86) 800-999-6836

<http://www.printronix.com/support.aspx>

Printronix Supplies Department

Contact the Printronix Supplies Department for genuine Printronix supplies.

Americas	(800) 733-1900
Europe, Middle East, and Africa	(33) 1 46 25 19 07
Asia Pacific	(65) 6548 4100
China	(86) 400-886-5598
India	1800 102 7869

<http://www.printronix.com/supplies-parts.aspx>

Corporate Offices

Printronix, LLC.
6440 Oak Canyon RD, Suite 200
Irvine, CA 92618
U.S.A.
Phone: (714) 368-2300
Fax: (714) 368-2600

Printronix LLC.
c/o Printronix Nederland BV
Bijsterhuizen 11-38
6546 AS Nijmegen
The Netherlands
Phone: (31) 24 6489489
Fax: (31) 24 6489499

Printronix Schweiz GmbH
3 Changi Business Park Vista
#04-05 AkzoNobel House
Singapore 486051
Phone: (65) 6548 4100
Fax: (65) 6548 4111

Printronix Commercial (Shanghai) Co. Ltd.
Room 903, 9th Floor
No. 199, North Xizang Road
200070 Shanghai P.R. China
Phone: (86) 400 886 5598
Fax: (8621) 61171256

Printronix India Pvt Ltd
B-808/809, BSEL Tech Park
8th Floor, Sector 30A
Vashi Navi Mumbai 400705
India
Toll Free No.: 1800 102 7896
Fax: (9122) 4158 5555

Visit the Printronix web site at www.printronix.com

256387-001 F